

Calibration
Manual

HP 37717C
Communications
Performance Analyzer

© Copyright Hewlett-Packard Ltd.1998

All rights reserved.
Reproduction, adaption,
or translation without prior
written permission is
prohibited, except as
allowed under the
copyright laws.

HP Part No. 37717-90435

Second Edition, Nov 98

Printed in U.K.

Documentation Warranty

The information contained
in this document is subject
to change without notice.

*Hewlett-Packard makes no
warranty of any kind with
regard to this material,
including, but not limited
to, the implied warranties
or merchantability and
fitness for a particular
purpose.*

Hewlett-Packard shall not
be liable for errors
contained herein or for
incidental or
consequential damages in
connection with the
furnishing, performance,
or use of this material.

WARNING

For details of safety, see
Safety information in this
manual.

HP Part Number 37717-90435

Printed in U.K. November 1998

**HP 37717C Communications
Performance Analyzer**

1 General Information

Warranty 1-1

Responsibilities of the Customer 1-2

Certification 1-3

Assistance 1-3

Notice 1-3

Restricted Rights Legend 1-3

Instruments Covered By Manual 1-4

Storage and Shipment 1-4

Repackaging for Shipment 1-4

Weight and Dimensions 1-5

Safety Precautions for the Operator 1-6

Lifting/Carrying the HP 37717C 1-6

Using both arms to lift instrument. 1-6

Safety Symbols 1-7

Operators Maintenance 1-8

Cleaning 1-8

Cabinet Cleaning 1-8

Optical Connector Cleaning 1-8

Power Supply Fuse Replacement 1-9

Statement of Compliance 1-10

Australian EMC Regulations 1-10

Noise Declaration (German) 1-10

Electromagnetic Compatibility 1-11

Electrostatic Discharge 1-11

Specifications 1-13

Unframed PDH (Option UKK) 1-13

Structured PDH (Options UKJ, UKL) 1-14

DS1/DS3/E1/E3 structured test interfaces (Option 110) 1-17

DSn/PDH receiver 1-18

SDH MODULE: Option US1 1-19

STS-3/STM-1e and STM-0/STM-1e test and interfacing (Option 120)
(for SDH specification see A3R) 1-26

STM-1/STM-4 OPTICAL INTERFACE: Option UH2. 1-34

STM-1/STM-4 OPTICAL INTERFACE: Option URU. 1-34

STM-1/STM-4 OPTICAL INTERFACE (1310 nm) with STM-4 Overhead Option
UKT 1-35

STM-1/STM-4 (1310/1550 nm) OPTICAL INTERFACE with STM-4 Overhead
Option USN 1-36

STM-0/STM-1/STM-4 OPTICAL INTERFACE (1310 nm) with STM-4c Overhead
Option 131 1-38

STM-0/STM-1/STM-4 OPTICAL INTERFACE (1310/1550 nm) with STM-4c
Overhead Option 130 1-40

SDH Binary Interface (Option 0YH) 1-42

MEASUREMENTS and ANALYSIS 1-54

UNFRAMED PDH (Option UKK) 1-55

SDH (Option US1) 1-57

JITTER (Options UHN, A1M, A1N, A1P, A3L, A3V and A3N) 1-62

ATM Measurement (Option UKN) 1-62

Recommended Test Equipment 1-67

2 Installation

Initial Inspection 2-1

Operating Environment 2-2

Preparation for Use 2-3

Power Requirements 2-3

Fuses 2-3

Fuse Replacement 2-3

Connecting to the Power Supply 2-4

Line Voltage Selector Switch 2-4

Power Cord 2-5

Connecting to the Network 2-6

All Connectors 2-6
Electrical Interface Connectors 2-6
Optical Interface Connectors 2-10
Laser Product Classification 2-10
Laser Warning Symbols 2-11
Swedish and Finnish Labels 2-12
Location of Laser Apertures on Options 130 and 131 2-13
Cleaning Optical Connectors 2-14
Connecting Accessories 2-15
10 Base-T Lan Connection Radiated Emissions 2-15
Hewlett-Packard Interface Bus 2-16
HP-IB Address Selection 2-17
Additional Precautions for Service Engineers 2-18
Safety Precautions 2-18
ESD Precautions 2-18

3 Performance Tests

Introduction 1
Equipment Required 1
Extra Modules Required 1
Performance Test Record 1
Calibration Cycle 1
Recall Default Settings 2
Self Test - All Options 3
Description 3
Additional Tests 4
PDH Internal Transmitter Clocks (Options UKK, [USB], UKJ,
[USA]) 6
Specifications 6
Description 6

Equipment Required	6
Procedure	7
Frequency Offsets	8
PDH Transmitter Output (UKK, [USB], UKJ, [USA]	9
Specifications	9
Description	10
Equipment Required	10
Procedure	10
704 kb/s Balanced Output	11
2.048 Mb/s Balanced Output	14
8.448 Mb/s Unbalanced Output	14
Multiple PDH Transmitter Outputs (Options UHC, [US6])	22
Specifications	22
Description	22
Equipment Required	23
Procedure	23
704 kb/s Output Pulse	23
704 kb/s Additional Outputs Delay	24
2.048 Mb/s Output Pulse	25
2.048 Mb/s Additional Output Delay	27
8.448 Mb/s Output Pulse	27
8.448 Mb/s Additional Output Delay	29
34.368 Mb/s Output Pulse	29
34.368 Mb/s Additional Outputs Delay	31
139.264 Mb/s Output Pulse	31
Additional Outputs Delay at 139.264 Mb/s	34
PDH Frame Analysis (Options UKK, [USB])	35
Specifications	35
Equipment Required	35
Description	35
Procedure	36
Option UKK, [USB] Unstructured PDH	36
Option UKJ, [USA] Structured PDH	36

2 Mb/s Frame Analysis	37
8 Mb/s Frame Analysis	39
34 Mb/s Frame Analysis	40
140 Mb/s Frame Analysis	41
PDH Receiver Equalization (Options UKK, [USB], UKJ, [USA], UKL, [USC], UKN, [USE])	43
Specifications	43
Description	43
Equipment Required	43
Procedure	44
704 kb/s	44
2.048 Mb/s	45
8.448 Mb/s	46
34.368 Mb/s	46
139.264 Mb/s	46
PDH Receiver Monitor Levels (Options UKK, [USB])	47
Specification	47
Description	47
Equipment Required	47
Procedure	47
704 kb/s	48
2.048 Mb/s	49
8.448 Mb/s	49
34.368 Mb/s	49
139.264 Mb/s	49
SPDH Receiver Monitor Levels (Options UKJ, [USA], UKL, [USC], UKN, [USE])	50
Specifications	50
Description	50
Equipment Required	50
Procedure	51
2.048 Mb/s	52

8.448 Mb/s	53
34.368 Mb/s	53
139.264 Mb/s	54
External 2Mb/s Mux/Demux (Options UKJ, [USA], UKN, [USA])	55
Specifications	55
Equipment Required	56
Procedure	56
External 2Mb/s Demux (Options UKL, [USC])	62
Specifications	62
Description	62
Equipment Required	62
Procedure	63
PDH Receiver Monitor Levels (Special Option 808)	68
Specification	68
Description	68
Procedure	68
704 kb/s	69
2.048 Mb/s	70
8.448 Mb/s	70
34.368 Mb/s	70
139.264 Mb/s	70
PDH Error Output (Options UKK, [USB])	71
Specifications	71
Description	71
Equipment Required	71
Procedure	71
Error Output Signal	72
PDH Frequency Measurement and Looped Clock (Options UKK, [USB], UKJ, [USA], UKL, [USC], UKN, [USE])	73
Specifications	73
Description	73
Equipment Required	73
Procedure	73

Internal SDH Transmitter Clock (Options US1, [US5], A1T, [A1U], A3R [A3S]) 77
Specification 77
Description 77
Equipment Required 77
Procedure 77

SDH Frequency Offsets (Options US1, [US5], A1T, [A1U], A3R [A3S], 120) 79
Specifications 79
Description 79
Equipment Required 79
Procedure 79

External MTS Clock (Options US1, [US5], A1T, [A1U], A3R [A3S], 120) 82
Specifications 82
Description 82
Procedure 82

External MTS - 2MHz Clock 82
External MTS - 2MHz Data 83
BITS 1.5 Mb/s (Option 120 only) 83
External - MTS 64k Clock 84
STM-1 RX 84
84

STM-1 Transmitter Output Waveshape (Options US1, [US5], A1T, [A1U], A3R [A3S], 120) 85
Specifications 85
Description 85
Procedure 85

STM-1 Receiver Monitor Input (Options US1, [US5]) 91
Specification 91
Description 91
Procedure 91

STM-1 Receiver Monitor Input (Options A1T, [A1U], A3R [A3S], 120) 93

Specification 93

Description 93

Equipment Required 93

Procedure 93

STM-1 Receiver Monitor Input (Special Option 808) 95

Specification 95

Description 95

Equipment Required 95

Procedure 95

STM-1 Receiver Input Equalization (Options US1, [US5], A1T, [A1U], A3R [A3S], 120) 97

Specification 97

Description 97

Procedure 97

STM-1 Optical Interface (Option UH1) 98

Specification (Transmitter) 98

Specification (Receiver) 98

Description 98

Equipment Required 99

Procedure 99

STM-1/STM-4 Optical Interface (Option UH2) 101

Specification (Transmitter) 101

Specification (Receiver) 101

Description 101

Equipment Required 102

Procedure 102

STM-1/STM-4, 1550nm Optical Interface (Option URU) 104

Specification (Transmitter) 104

Specification (Receiver) 104

Description 104

Equipment Required 105

Procedure	105
STM-1/STM-4 Optical Interface (Options UKT, USN)	109
Specification (Transmitter)	109
Specification (Receiver)	109
Description	109
Equipment Required	110
Procedure Option UKT and USN	111
Procedure Option USN only	113
STM-1/STM-4 Optical Interface (Options 130, 131)	117
Specification (Transmitter)	117
Specification (Receiver)	117
Description	117
Procedure Option 130 and 131	118
Procedure Option 130 only	121
Transmitted Jitter Amplitude Accuracy (Option UHK)	125
Specifications	125
Description	126
Equipment Required	126
Pre-Adjustment Setup	126
Procedure	127
Transmitted Jitter/Wander Amplitude Accuracy (Option A3K [A3Q])	132
Specifications	132
Jitter Generation:	132
Amplitude Range:	132
External Jitter:	133
Wander Generation:	133
Wander Timing Reference Input:	133
External Jitter Modulation Input:	133
Description	134
Equipment Required	135
Pre-Adjustment Setup	135
Procedure	136

Transmitted PDH Jitter Amplitude Accuracy on Range 1 136

Transmitted PDH Jitter Accuracy on Range 10 139

Transmitted SDH Jitter Accuracy on Ranges 1 & 10 141

Transmitted SDH Jitter Accuracy on Range 50 143

Transmitted PDH Jitter Accuracy on Range 80 144

External Jitter Generation 145

Wander Generation 146

Received Jitter Accuracy (Options UHN, [US9], A1M [A1Q], A1N [A1R], A1P [A1S], A3L [A3M], A3V [A3W], A3N [A3P]) 149

Specifications 149

Overall Accuracy: See main specifications in Section 1. 149

Description 149

Equipment Required 149

Received Jitter Accuracy Procedure 150

Hit Count 151

Demodulated Jitter Output 152

Wander/Slips Measurement (Options UHN, [US9], A1M [A1Q], A1N [A1R], A1P [A1S], A3L [A3M], A3V [A3W], A3N [A3P]) 153

Specifications 153

Timing Reference Input: 153

Wander Measurement: 153

Description 154

Equipment Required 154

Procedure 154

Jitter Receiver STM-1E Input Equalization (Options A1M [A1Q], A1N [A1R], A1P [A1S], A3L [A3M], A3V [A3W], A3N [A3P]) 159

Specification 159

Description 159

Equipment Required 159

Procedure 159

Jitter Receiver STM-1E Monitor Input (Options A1M [A1Q], A1N [A1R], A1P [A1S], A3L [A3M], A3V [A3W], A3N [A3P]) 160

- Specification 160
- Description 160
- Equipment Required 160
- Procedure 160

Jitter Receiver STM-1 Optical Interface (Options A1N, [A1R], A3V [A3W]) 162

- Specification 162
- Description 162
- Equipment Required 162
- Procedure 163

Jitter Receiver STM-1/STM-4 Optical Interface (Options A1P, [A1S], A3N [A3P]) 165

- Specification 165
- Description 165
- Equipment Required 165
- Procedure 166

PDH Binary Interfaces (Option UH3, [US7]) 168

- Specifications 168
- Description 169
- Procedure 169
- External Clock Thresholds 169
- External Clock Mark to Space Ratio 172

ETSI/ANSI Internal Transmitter Clock Rates (Option UKZ) 176

- Specification 176
- Description 176
- DS3 Frequency Accuracy 176
- E1 (2.048Mb/s) Frequency Accuracy 177
- E3 (34.368Mb/s) Frequency Accuracy 177
- DS1 Frequency Accuracy 178

ETSI/ANSI Transmitter Output Level and Waveshape (Option UKZ) 179

Specifications	179
Description	179
34.368 Mb/s Positive Pulse	180
34.368 Mb/s Negative Pulse	181
2.048 Mb/s Positive Pulse	182
2.048 Mb/s Negative Pulse	184
DSX-3 Positive Pulse	185
DSX-3 Negative Pulse	186
DSX-1 Positive Pulse	187
DSX-1 Negative Pulse	188
ETSI/ANSI Receiver Equalization (Option UKZ)	190
Specifications	190
Description	190
2.048Mb/s Equalization	190
34.368 Mb/s Equalization	191
DS3 Equalization	192
DS1 Equalization	193
ETSI/ANSI Receiver Monitor Levels (Option UKZ)	194
Specifications	194
Description	194
2.048Mb/s 20dB Monitor	195
2.048Mb/s 26dB Monitor	196
2.048Mb/s 30dB Monitor	196
34.368 Mb/s 20dB Monitor	196
34.368 Mb/s 26dB Monitor	197
DS3 20dB Monitor	198
DS3 26dB Monitor	198
DS1 20dB Monitor	199
DS1 26dB Monitor	200
DS1 30dB Monitor	200
Trigger Output (Option UKZ)	201
Specification	201
Description	201
Trigger Pulse	201

Internal SONET Transmitter Clock (Option 120)	204
Specification	204
Description	204
Equipment Required	204
Procedure	204
SONET Frequency Offsets (Option 120)	206
Specifications	206
Description	206
Equipment Required	206
Procedure	206
STS-3 Transmitter Output Waveshape (Option 120)	209
Specifications	209
Description	209
Procedure	209
STM-1/STS-3 Receiver Monitor Input (Options A1T, A1U, A3R, [A3S], 120)	215
Specification	215
Description	215
Equipment Required	215
Procedure	215
STM-1/STS-3 Receiver Input Equalization (Options US1, [US5], A1T, [A1U], A3R, [A3S],120)	217
Specification	217
Description	217
Procedure	217
ETSI/ANSI Internal Transmitter Clock Rates (Option 110)	218
Specification	218
Description	218
E3 (34.368Mb/s) Frequency Accuracy	218
E1 (2.048Mb/s) Frequency Accuracy	219
DS1 Frequency Accuracy	219
DS3 Frequency Accuracy	219

ETSI/ANSI Transmitter Output Level and Waveshape (Option 110)

221

Specification 221

Description 221

34.368 Mb/s Positive Pulse 222

34.368 Mb/s Negative Pulse 223

2.048 Mb/s Positive Pulse 223

2.048 Mb/s Negative Pulse 225

DSX-3 Positive Pulse 225

DSX-3 Negative Pulse 226

DSX-1 Positive Pulse 227

DSX-1 Negative Pulse 228

ETSI/ANSI Receiver Equalization (Option 110) 229

Specifications 229

Description 229

34.368 Mb/s Equalization 229

2.048Mb/s Equalization 230

DS3 Equalization 231

DS1 Equalization 232

ETSI/ANSI Receiver Monitor Levels (Option 110) 233

Specifications 233

Description 233

Equipment Required 233

Procedure 234

2.048 Mb/s 235

1.544 Mb/s (DS-1) 236

34.368 Mb/s 236

44.736 Mb/s (DS-3) 236

Performance Test Record 237

1 Terms

ETSI / ANSI Equivalent Terms	4-1
Current / Previous Terminology	4-3
Retrofit Procedure	B-4
Testing	B-5
Jitter Transmitter Module Calibration	B-6
Description	B-6
Equipment	B-6
Pre-Adjustment Setup	B-6
Jitter Transmitter Calibration Procedure	B-7

General Information

Warranty

HP PRODUCT

DURATION OF WARRANTY

HP 37717C

3 years

- 1** HP warrants HP hardware, accessories and supplies against defects in materials and workmanship for the period specified above. If HP receives notice of such defects during the warranty period, HP will, at its option, either repair or replace products which prove to be defective. Replacement products may be either new or like-new.
- 2** HP warrants that HP software will not fail to execute its programming instructions, for the period specified above, due to defects in material and workmanship when properly installed and used. If HP receives notice of such defects during the warranty period, HP will replace software media which does not execute its programming instructions due to such defects.
- 3** HP does not warrant that the operation of HP products will be uninterrupted or error free. If HP is unable, within a reasonable time, to repair or replace any product to a condition as warranted, customer will be entitled to a refund of the purchase price upon prompt return of the product.
- 4** HP products may contain remanufactured parts equivalent to new in performance or may have been subject to incidental use.
- 5** The warranty period begins on the date of delivery or on the date of installation if installed by HP. If customer schedules or delays HP installation more than 30 days after delivery, warranty begins on the 31st day from delivery.
- 6** Warranty does not apply to defects resulting from (a) improper or inadequate maintenance or calibration, (b) software, interfacing, parts or supplies not supplied by HP, (c) unauthorized modification or misuse, (d) operation outside of the published environmental specifications for the product, or (e) improper site preparation or maintenance.
- 7** TO THE EXTENT ALLOWED BY LOCAL LAW, THE ABOVE WARRANTIES ARE EXCLUSIVE AND NO OTHER WARRANTY OR CONDITION, WHETHER WRITTEN OR ORAL, IS EXPRESSED OR

General Information

Warranty

IMPLIED AND HP SPECIFICALLY DISCLAIMS ANY IMPLIED WARRANTIES OR CONDITIONS OF MERCHANTABILITY, SATISFACTORY QUALITY, AND FITNESS FOR A PARTICULAR PURPOSE.

- 8 HP will be liable for damage to tangible property per incident up to the greater of \$300,000 or the actual amount paid for the product that is the subject of the claim, and for damages for bodily injury or death, to the extent that all such damages are determined by a court of competent jurisdiction to have been directly caused by a defective HP product.
- 9 TO THE EXTENT ALLOWED BY LOCAL LAW, THE REMEDIES IN THIS WARRANTY STATEMENT ARE CUSTOMER'S SOLE AND EXCLUSIVE REMEDIES. EXCEPT AS INDICATED ABOVE, IN NO EVENT WILL HP OR ITS SUPPLIERS BE LIABLE FOR LOSS OF DATA OR FOR DIRECT, SPECIAL, INCIDENTAL, CONSEQUENTIAL (INCLUDING LOST PROFIT OR DATA), OR OTHER DAMAGE, WHETHER BASED IN CONTRACT, TORT, OR OTHERWISE.

FOR CONSUMER TRANSACTIONS IN AUSTRALIA AND NEW ZEALAND: THE WARRANTY TERMS CONTAINED IN THIS STATEMENT, EXCEPT TO THE EXTENT LAWFULLY PERMITTED, DO NOT EXCLUDE, RESTRICT OR MODIFY AND ARE IN ADDITION TO THE MANDATORY STATUTORY RIGHTS APPLICABLE TO THE SALE OF THIS PRODUCT TO YOU.

Responsibilities of the Customer

The customer shall provide:

- 1 Access to the products during the specified periods of coverage to perform maintenance.
- 2 Adequate working space around the products for servicing by Hewlett-Packard personnel.
- 3 Access to and use of all information and facilities determined necessary by Hewlett-Packard to service and/or maintain the products. (Insofar as these items may contain proprietary or classified information, the customer shall assume full responsibility for safeguarding and protection from wrongful use.)
- 4 Routine operator maintenance and cleaning as specified in the Hewlett-Packard Operating and Service Manuals.
- 5 Consumables such as paper, disks, magnetic tapes, ribbons, inks, pens, gases, solvents, columns, syringes, lamps, septa, needles, filters, frits, fuses, seals, detector flow cell windows, etc.

General Information

Warranty

Certification

Hewlett-Packard Company certifies that this product met its published specifications at the time of shipment from the factory. Hewlett-Packard further certifies that its calibration measurements are traceable to the United States National Bureau of Standards, to the extent allowed by the Bureau's calibration facility and to the calibration facilities of other International Standards Organization members!

Assistance

Product maintenance agreements and other customer assistance agreements are available for Hewlett-Packard products.

Notice

The information contained in this document is subject to change without notice.

Hewlett-Packard shall not be liable for errors contained herein or for incidental or consequential damages in connection with the furnishing, performance or use of this material.

This document contains proprietary information which is protected by copyright. All rights are reserved. No part of this document may be photocopied or reproduced without the prior written consent of the manufacturer, Hewlett-Packard Ltd.

Restricted Rights Legend

Use, duplication, or disclosure by the government is subject to restrictions as set forth in subdivision (b)(3)(ii) of the Rights in Technical Data and Computer Software clause at 52.227-7013. Hewlett-Packard Company; 3000 Hanover Street; Palo Alto, California 94304.

Instruments Covered By Manual

Attached to the rear panel of the instrument is a serial number plate. The serial number plate has a two letter reference denoting country of origin (GB = Great Britain) and an eight digit serial number. The serial number is unique to each instrument and should be quoted in all correspondence with Hewlett-Packard, especially when ordering replacement parts.



Serial Number Plate

Storage and Shipment

The instrument may be stored or shipped in environments within the following limits:

Temperature	-20° C to +70° C -15° C to +50° C with lid printer
Altitude	Up to 15,200 meters (50,000 feet)

The instrument should also be protected from temperature extremes which could cause condensation within the instrument.

Repackaging for Shipment

Tagging for Service. If the instrument is being returned to Hewlett-Packard for service, please complete a repair tag and attach it to the instrument.

General Information

Weight and Dimensions

Original Packaging. Containers and materials identical to those used in factory packaging are available from Hewlett-Packard offices. If the instrument is being returned to Hewlett-Packard for servicing, attach a tag indicating the type of service required, return address, model number, and full serial number. Mark the container FRAGILE to ensure careful handling. In any correspondence, refer to the instrument by model number and full serial number.

Other Packaging. The following general instructions should be followed when repackaging with commercially available materials:

- Wrap instrument in heavy paper or plastic. If the instrument is being shipped to Hewlett-Packard, attach a tag indicating the type of service required, return address, model number and full serial number.
- Use a strong shipping container. A double wall carton made of 350 pound test material is adequate.
- Use a layer of shock absorbing material 70 to 100 mm (3 to 4 inch) thick, around all sides of the instrument to provide firm cushioning and prevent movement inside the container. Protect the Front Panel controls and Rear Panel connectors with cardboard.
- Seal shipping container securely.
- Mark shipping container FRAGILE to ensure careful handling.
- In any correspondence, refer to instrument by model number and full serial number.

Weight and Dimensions

Weight: 18 kg (40 lb) fully loaded

Dimensions: 190mm (7.5in) high, 340mm (14in) wide, 420mm (17in) deep (including cover).

Safety Precautions for the Operator

The following general safety precautions must be observed during all phases of operation, service, and repair of this instrument. Failure to comply with these precautions or with specific warnings elsewhere in this manual violates safety standards of design, manufacture, and intended use of the instrument. Hewlett-Packard Company assumes no liability for the customer's failure to comply with these requirements.

In particular, the operator should note the following safety information:

- “Safety Symbols” on page 1-7
- “Connecting to the Power Supply” on page 2-4
- “Operating Environment” on page 2-2
- “Fuse Replacement” on page 2-3
- “Operators Maintenance” on page 1-8
- “Lifting/Carrying the HP 37717C” on page 1-6

DO NOT operate damaged equipment: Whenever it is possible that the safety protection features built into this product have been impaired, either through physical damage, excessive moisture, or any other reason, **REMOVE POWER** and do not use the product until safe operation can be verified by service-trained personnel. If necessary, return the product to a Hewlett-Packard Sales and Service Office for service and repair to ensure the safety features are maintained.

Lifting/Carrying the HP 37717C

Before attempting to lift or carry the instrument consider the following basic lifting techniques to help avoid personal injury.

Using both arms to lift instrument.

- Reach for the instrument - bend your knees and waist, and keep your back straight.
- GRASP the instrument firmly.
- LIFT with your legs.
- KEEP your shoulders level.

General Information

Safety Precautions for the Operator

Safety Symbols

The following symbols on the instrument and in the manual indicate precautions which must be taken to maintain safe operation of the instrument



The Instruction Documentation Symbol. The product is marked with this symbol when it is necessary for the user to refer to the instructions in the supplied documentation.



Indicates the field wiring terminal that must be connected to earth ground before operating the equipment - protects against electrical shock in case of fault.

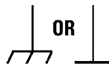

Frame or chassis ground terminal - typically connects to the equipment's metal frame.



Alternating current (AC)



Direct current (DC)



Indicates hazardous voltages

WARNING

Warning denotes a hazard. It calls attention to a procedure, which if not correctly performed or adhered to could result in injury or loss of life. Do not proceed beyond a warning note until the indicated conditions are fully understood and met.

CAUTION

Caution denotes a hazard. It calls attention to a procedure, which if not correctly performed or adhered to could result in damage to or destruction of the instrument. Do not proceed beyond a warning note until the indicated conditions are fully understood and met.



Indicates that a laser is fitted. The user must refer to the manual for specific Warning or Caution information to avoid personal injury or damage to the product.

Operators Maintenance

WARNING

NO OPERATOR SERVICEABLE PARTS INSIDE. REFER SERVICING TO QUALIFIED PERSONNEL. TO PREVENT ELECTRICAL SHOCK DO NOT REMOVE COVERS.

Maintenance appropriate for the operator is:

- Cabinet cleaning
- Optical Connector Cleaning
- Power supply fuse replacement

Cleaning

Cabinet Cleaning

Clean the cabinet using a dry cloth only.

Optical Connector Cleaning

It is recommended that the optical connectors be cleaned at regular intervals using the following materials:

Description	HP Part Number
Blow Brush	9300-1131
Isopropyl Alcohol	8500-5344
Lens Cleaning Paper	9300-0761
Adhesive Tape Kit	15475-68701

CAUTION

Do not insert any tool or object into the IN or OUT ports of the instrument as damage to or contamination of the optical fibre may result.

- 1 Recall Default settings (STORED SETTINGS 0) and remove the power from the HP 37717C.

General Information

Operators Maintenance

- 2 Remove the adapters from the IN and OUT ports.
- 3 Using the blow brush with the brush removed blow through the ferrule of the standard flexible connector and the adapter.

CAUTION

If the optical fibre of the fixed connector requires further cleaning this entails disassembly of the module which should only be carried out by suitably trained service personnel.

- 4 Apply some isopropyl alcohol to a piece of the cleaning paper and clean the barrel of the adapter. Using a new piece of cleaning paper, clean the face of the adapter. Repeat this operation, using a new piece of cleaning paper each time.
- 5 Lightly press the adhesive side of the tape provided against the front of the adapter, then remove it quickly - repeat twice. This removes any particles of cleaning paper which may be present.
- 6 Replace the adapters on the flexible connector.

Power Supply Fuse Replacement

See "Fuse Replacement" on page 2-3

Statement of Compliance

This instrument has been designed and tested in accordance with IEC Publication 1010-1 + A1:1992 Safety requirements for Electrical Equipment for Measurement, Control and Laboratory Use, and has been supplied in a safe condition. The instruction documentation contains information and warnings which must be followed by the user to ensure safe operation and to maintain the instrument in a safe condition.



The CE mark shows that the product complies with all relevant European legal Directives.

ISM 1-A

This is a symbol of an Industrial Scientific and Medical Group 1 Class A product.



The CSA mark is a registered trademark of the Canadian Standards Association.

Australian EMC Regulations



The C-Tick mark is a registered trademark of the Spectrum Management Agency of Australia. This signifies compliance with the Australian EMC Framework Regulations under the terms of the Radiocommunications Act of 1992.

Noise Declaration (German)

LpA<70dB

am Arbeitsplatz (operator position)

normaler Betrieb (normal position)

nach DIN 45635 pt.19 (per ISO 7779)

Electromagnetic Compatibility

This product has been designed to meet the protection requirements of the European Communities Electromagnetic Compatibility (EMC) directives:

EN55011:1991 (Group 1, Class A)

EN50082-1:1992

- IEC 1000-4-2 (1995) ESD

- IEC 1000-4-3 (1995) Radiated Susceptibility

- IEC 1000-4-4 (1995) EFT

In order to preserve the EMC performance of the product, any cable which becomes worn or damaged must be replaced with the same type and specification.

Electrostatic Discharge

When an air discharge is applied to the HP37717C in accordance with IEC 801-2 (1991), degradation in performance may be observed in the form of occasional bit errors being counted.

See also “10 Base-T Lan Connection Radiated Emissions” on page 2-15

General Information
Electromagnetic Compatibility

Declaration of Conformity

according to ISO/IEC Guide 22 and EN45014

Manufacturer's Name: Hewlett-Packard Ltd.

Manufacturer's Address: Telecomms Networks Test Division
South Queensferry
West Lothian, EH30 9TG
Scotland, United Kingdom

Declares that the product

Product Name: Communications Performance Analyzer

Model Numbers: HP 37717C

Product Options: This declaration covers all options of the above products as detailed in TCF A-5951-9852-01

Conforms with the protection requirements of European Council Directive 89/336/EEC on the approximation of the laws of the member states relating to electromagnetic compatibility.

Against EMC test specifications EN 55011:1991 (Group 1, Class A) and EN 50082-1:1992

As Detailed in: Electromagnetic Compatibility (EMC)
Technical Construction File (TCF) No. A-5951-9852-01

Assessed by: Dti Appointed Competent Body
EMC Test Centre,
GEC-Marconi Avionics Ltd.,
Maxwell Building,
Donibristle Industrial Park,
KY11 5LB
Scotland, United Kingdom

Technical Report Number:6893/2200/CBR, dated 21 August 1997

Supplementary Information:

The product conforms to the following safety standards:

EN 61010-1(1993) / IEC 1010-1(1990) +A1(1992)
CSA-C22.2 No. 1010.1-92
CFR Ch.1 1040.10
EN 60825-1(1994) / IEC 825-1 (1993)

The product herewith complies with the requirements of the Low Voltage Directive 73/23/EEC, and carries the CE-marking accordingly.

South Queensferry, Scotland

18 September 1997



Location

Date

W.R. Pearson / Quality Manager

Specifications

Except where otherwise stated, the following parameters are warranted performance specifications. Parameters described as “typical” or “nominal” are supplemental characteristics which provide a useful indication of typical but non-warranted performance characteristics.

Unframed PDH (Option UKK)

Transmitter

PDH Bit rates: 704 kb/s, 2.048 Mb/s, 8.448 Mb/s, 34.368 Mb/s, 139.264Mb/s

Frequency offset: Up to ± 100 ppm

Interface: Meets ITU-T G.703

Connectors: BNC 75Ω unbalanced, 3 pin Siemens 120Ω balanced

Test patterns PRBS: $2^{15}-1$, $2^{23}-1$ at all rates (ITU-T O.151)

Word: User-defined 16 bit word, all ones, all zeros, 1010, 1000.

Output:

704 kb/s, 2.048 Mb/s: HDB3 or AMI balanced/unbalanced.

8.448 Mb/s: HDB3 or AMI unbalanced.

34.368 Mb/s: HDB3 unbalanced.

139.264 Mb/s: CMI unbalanced.

Bit error add: 1 in 10^3 or single error

Clock timing Internal: All rates **Recovered (loop timed):** From 704 kb/s or 2.048 Mb/s receiver input.

Receiver

Input:

704 kb/s, 2.048 Mb/s: ± 100 ppm, balanced/unbalanced.

8.448 Mb/s: ± 100 ppm, unbalanced.

34.368 Mb/s: ± 100 ppm, unbalanced.

139.264 Mb/s: ± 100 ppm, unbalanced.

Line codes: As transmitter.

Autosetup: Bit rate, test pattern, framing and level of an incoming signal.

General Information

Specifications

Jitter tolerance: To ITU-T Rec G.823.

Synchronization: Sync loss when BER $\geq 1:16$ over 100 ms. Sync gain when BER $< 1:16$.

Equalization: To ITU-T Rec G.703.

Monitor point compensation:

704 kb/s, 2.048 Mb/s, 8.448 Mb/s: 26 to 30 dB.

34.368, 139.264 Mb/s: 26 dB.

Frame Formats

2 Mb/s: PCM30 CAS with or without CRC4. PCM31 with or without CRC4

8 Mb/s, 34 Mb/s, 140 Mb/s: Framed.

Structured PDH (Options UKJ, UKL)

Option UKJ provides Structured PDH generation and measurement at standard bit rates. Option UKL provides measurement **only** at standard bit rates.

Transmitter (Option UKJ)

Interface Bit rates: 2.048 Mb/s, 8.448 Mb/s, 34.368 Mb/s and 139.264 Mb/s.

Frequency offset: Up to ± 100 ppm

Interface: Meets ITU-T G.703

Connectors: BNC 75Ω unbalanced, 3 pin Siemens 120Ω balanced

Test patterns

PRBS: 2^9-1 , $2^{11}-1$, $2^{15}-1$, $2^{23}-1$ at all rates.

Word: User-defined 16 bit word, all ones, all zeros, 1010, 1000.

Output:

2.048 Mb/s: HDB3 or AMI balanced/unbalanced.

8.448 Mb/s: HDB3 or AMI unbalanced.

34.368 Mb/s: HDB3 unbalanced.

139.264 Mb/s: CMI unbalanced.

Bit error add: 1 in 10^3 , 1 in 10^4 , 1 in 10^5 , 1 in 10^6 , 1 in 10^7 or single error

Frame error add: 1 in 10^3 , 1 in 10^4 , 1 in 10^5 , 1 in 10^6 , 1 in 10^7 or error 1 to 4 consecutive frames

Code error add: (2, 8, 34 Mb/s) 1 in 10^3 , 1 in 10^4 , 1 in 10^5 , 1 in 10^6 , 1 in 10^7 or single error

Clock timing Internal: All rates

Recovered (loop timed): From 2.048 Mb/s receiver input.

General Information

Specifications

Test signal rates: N X 64 kb/s, 64 kb/s, 2.048 Mb/s, 8.448 Mb/s, 34.368 and 139.264 Mb/s.

Frame Formats

All Rates: Unframed, Framed or Structured.

2 Mb/s, and 64 kb/s Framing: PCM30 CAS with or without CRC4, PCM31 with or without CRC4. As ITU-T Rec. G.704

8 Mb/s Framing: As ITU-T Rec. G.742

34 Mb/s Framing: As ITU-T Rec. G.751

140 Mb/s Framing: As ITU-T Rec. G.751

Background Patterns: Unframed 2⁹-1 PRBS, AIS or same pattern as test signal.

External 2 Mb/s Mux I/P: Meets ITU-T Rec. G.703, unbalanced HDB3 signal only.

Receiver (Option UKJ, UKL)

Interface bit rate:

2.048 Mb/s: ±100 ppm balanced/unbalanced.

8.448 Mb/s: ±100 ppm unbalanced.

34.368 Mb/s: ±100 ppm unbalanced.

139.264 Mb/s: ±100 ppm unbalanced.

Line codes: As transmitter.

Autosetup: Bit rate, test pattern, framing and level of an incoming signal.

Synchronization: Sync loss when BER ≥ 20% over 100 ms for PRBS or ≥ 4% over 100 ms for word patterns. Sync gain when 32 consecutive error free bits received.

Equalization at f/2: 2.048 Mb/s, 8.448 Mb/s: 6 dB
34.368 Mb/s, 139.264 Mb/s: 12 dB

Monitor point compensation: 2.048 Mb/s, 8.448 Mb/s: 20 dB, 26 dB or 30 dB.
34.368, 139.264 Mb/s: 20 dB or 26 dB.

Frame Formats: As transmitter.

Frame Alignment 2 Mb/s: As ITU-T Rec. G.706

Frame Alignment 2 Mb/s CRC4: As ITU-T Rec. G.706.

Frame Alignment 2 Mb/s CAS: As ITU-T Rec. G.732.

Frame Alignment 8 Mb/s: As ITU-T Rec. G.742.

Frame Alignment 34 Mb/s: As ITU-T Rec. G.751.

Frame Alignment 140 Mb/s: As ITU-T Rec. G.751.

Frame Gain 2 Mb/s: 1 correct sequence of FAS-NFAS-FAS.

Frame Loss 2 Mb/s: 3 consecutive incorrect FAS or NFAS words.

Frame Gain 2 Mb/s CAS: 1 correct CAS multiframe and the previous CAS word is not 0000.

Frame Loss 2 Mb/s CAS: 2 consecutive errored CAS multiframe patterns or 16 frames with CAS word 0000.

PDH Binary Interfaces (Option UH3)

Option UH3. Provides binary interfaces for the PDH modules (Options UKK and UKJ)

Transmitter

Binary Data Output

Data rates: 700 kb/s to 50 Mb/s (TTL),

General Information

Specifications

700 kb/s to 170 Mb/s (ECL)

Format: NRZ

Source impedance: Nominal TTL into $75\ \Omega$ to ground or nominal ECL into $75\ \Omega$ to -2V

Return loss: Typically >15 dB, 500 kHz to 100 MHz (TTL)

Binary Clock Output

Clock rates: 700 kb/s to 50 Mb/s (TTL), 700 kb/s to 170 Mb/s (ECL)

Format: Nominal squarewave 60/40 to 40/60 duty cycle.

Source impedance: Nominal TTL into $75\ \Omega$ to ground or nominal ECL into $75\ \Omega$ to -2V

Return loss: Typically >10 dB, 500 kHz to 100 MHz (TTL)

External Clock Input

Clock rates: 700 kb/s to 50 Mb/s (TTL), 700 kb/s to 170 Mb/s (ECL)

Logic threshold: 1.5V (TTL), -1.3V (ECL), ground (0V), signal mean level.

Termination: Nominal TTL into $75\ \Omega$ to ground or nominal ECL into $75\ \Omega$ to -2V

Format: Nominal squarewave 60/40 to 40/60 duty cycle.

Return loss: Typically >15 dB, 500 kHz to 200 MHz (TTL)

Receiver

Binary Data Input

Data rates: 700 kb/s to 50 Mb/s (TTL), 700 kb/s to 170 Mb/s (ECL)

Logic threshold: 1.5V (TTL), -1.3V (ECL), ground (0V).

Format: NRZ

Termination: Nominal TTL into $75\ \Omega$ to ground or nominal ECL into $75\ \Omega$ to -2V

Return loss: Typically >15 dB, 500 kHz to 200 MHz (TTL)

Binary Clock Input

Clock rates: 700 kb/s to 50 Mb/s (TTL), 700 kb/s to 170 Mb/s (ECL)

Logic threshold: 1.5V (TTL), -1.3V (ECL), ground (0V), signal mean level.

Format: Nominal squarewave 60/40 to 40/60 duty cycle.

Termination: Nominal TTL into $75\ \Omega$ to ground or nominal ECL into $75\ \Omega$ to -2V

Return loss: Typically >15 dB, 500 kHz to 100 MHz (TTL)

Binary interface rates: 2, 8, 34 and 140 Mb/s if Option UKJ is fitted. 0.7, 2, 8, 34 and 140 Mb/s if Option UKK is fitted.

Frequency measurement: On external clock input and binary clock input.

Jitter generation: Simultaneous jitter of binary clock and binary data outputs if Option UHK or A3K (2, 8, 34 & 140 Mb/s) is fitted.

Jitter measurement: Jitter measurement of binary clock input if Option UHN, A1M, A1N, A1P, A3L, A3V or A3N (2, 8, 34 & 140 Mb/s ± 100 ppm) is fitted.

General Information

Specifications

DS1/DS3/E1/E3 structured test interfaces (Option 110)

OUT and IN ports (used for transmit and receive)

Type: Electrical: To ANSI T1.102-1993; ITU-T O.171, G.703.

Connectors: DS1 (1.554 Mb/s): WECO bantam, 100 Ω balanced. DS3 (44.736 Mb/s): BNC, 75 Ω unbalanced. E1 (2.048 Mb/s): BNC, 75 Ω unbalanced and WECO bantam, 120 Ω balanced. E3 (34.368 Mb/s): BNC, 75 Ω unbalanced.

Rate: 1.544, 2.048, 34.368, 44.736 Mb/s.

DSn/PDH transmitter

Clock timing: Internal: All rates; Recovered by the receiver.

Frequency offset generation: Up to 100 ppm in 1 ppm steps.

Clock output: Selected transmitter clock (internal or looped receiver clock) used to generate DS1/DS3/E1/E3 test output signal. (BNC connector, externally terminated 50 Ω to ground).

Line coding: DS1: B8ZS, AML. DS3: B3ZS. E1: AML, HDB3. E3: HDB3.

Output level: DS1: DSX-1, DS1-LO. DS3: DS3-HI, DSX-3, DS3-900'

Framing: All rates: Unframed, framed and structured. DS1: SF (D4). DS1: ESF to ANSI T1.403-1989, Bellcore TR-TSY-000499 and ITU-T G.704;

the ESF data link (DL) defaults to repetition of idle code (01111110).

DS3: M13 to ANSI T1.107-1995.

DS3: C-bit parity to ANSI T1.107a-1990. E1: To ITU-T G.706/G.732.

E3: To ITU-T G.751.

N x 64 kb/s structured to ITU-T G.704 for E1, E3

N x 64 kb/s and N x 56 kb/s structured for DS1 and DS3.

Test pattern: PRBS: 2^9-1 , $2^{11}-1$, $2^{15}-1$, $2^{20}-1$, $2^{23}-1$.

QRSS (DS1 only).

3-in-24 stress pattern (DS1 only).

Word: 1010, 1000, 16 bit user word, all ones, all zeros. The PRBS polarity of patterns is user selectable.

Error add: DS1: Bit, FAS (Frame Alignment Signal), BPV/code, CRC-6, EXZ (excess zeros).

DS3: Bit, FAS, MFAS (MultiFrame Alignment Signal), BPV/code, parity (P bits), CP (path parity), FEBE, EXZ (excess zeros).

E1: Bit, FAS, BPV/code, CRC-4, REBE. E3: Bit, FAS, BPV/code.

Error insertion rate: Single. 1.0E-3. 1.1E-3. 1.0E-4 to 9.9E-9. Mantissa step size 0.1, exponent step size 1.

Alarm generation: DS1: Loss of signal (LOS); Out of frame (OOF); alarm indication signal (AIS); remote alarm indication (RAI).

DS3: LOS; LOF; AIS; RAI; far end alarm and control (FEAC): As per T1.107-1995.

E1: LOS, LOF, AIS, RAI.

E3: LOS, LOF, AIS, RAI.

General Information

Specifications

FEAC code generation: With C-Bit parity framing loopback and alarm/status codes as per ANSI T1.107-1995 can be generated. Loopback codes: A single burst of N loopback codes and M messages where N and M are in the range 1 through 15.

Alarm/status codes: Any ANSI T1.107-1995 message or any 0xxxxxx01111111 message where x is selectable may be transmitted either in a single burst of 1 to 15 times or continuously.

Spare bits generation: The following spare bits can be modified;
34 Mb/s: FAS bit 12
2 Mb/s Si bits (international bits): Timeslot 0 bit 1 in both FAS and NFAS frames.
2 Mb/s E bits: CRC4 frames 13 and 15; timeslot 0 bit 1.
2 Mb/s Sa bit (national bits): NFAS timeslot bits 4 to 8.
2 Mb/s Sa bit sequences: An 8 bit sequence may be transmitted in any selected NFAS Sa bit when CRC4 framing has been selected. The sequence appears in odd-numbered CRC4 frames, starting at frame 1.
2 Mb/s CAS multiframe: MFAS timeslot bits 5, 7 and 8.

Signaling bits generation: DS1: User selectable Signaling ON or OFF. When ON user selectable AB bits for SF, ABCD for ESF and AB bits for SLC-96 framing.

Background patterns: Unframed 2^9-1 PRBS, AIS or same as test pattern as foreground test signal.

Ext DS1 mux input: Weco bantam connector, AMI or B8ZS.

Ext 2 Mb/s mux input: BNC to ITU-T G.703, AMI or B8ZS.

DSn/PDH receiver

Type, connectors, rates, line code and framing: As for DSn/PDH transmitter.

Jitter tolerance: To Bellcore TR-TSY-000009 (DS1/DS3) and ITU-T O.171.

Operating level (terminate):

User selectable as follows:

DS1 (balanced): DSX-1 to DS1-LO levels.

DS3 (unbalanced): DS3-HI, DSX-3 and DS3-900 levels.

E1 (balanced): 3.0 V \bar{n} 20% for cable lengths as per ITU-T G.703.

E1 (unbalanced): 2.37 V \bar{n} 20% for cable lengths as per ITU-T G.703.

E3 (unbalanced): 1.0 V \bar{n} 20% with automatic equalization for cable lengths as per ITU-T G.703.

Monitor point compensation:

DS1 (balanced), E1 (balanced and unbalanced): 20, 26 or 30 dB gain relative to terminate mode. E1 (balanced) is restricted to half cable length with respect to ITU-T G.703 for 26 and 30 dB gains.

DS3 and E3: 20 or 26 dB gain relative to terminate mode.

Framing: All rates: Unframed, framed and structured. DS1: ESF (D4).

DS1: ESF to ANSI T1.403-1989, Bellcore TR-TSY-000499 and ITU-T G.704; the ESF data link (DL) defaults to repetition of idle code (01111110); DS3: M13 to ANSI T1.107-1995.

General Information

Specifications

DS3: C-bit parity to ANSI T1.107a-1990. E1: To ITU-T G.706/G.732
E3: To ITU-T G.751
N x 64 kb/s structured to ITU-T G.704 for E1, E3
N x 64 kb/s and N x 56 kb/s structured for DS1 and DS3.

SDH MODULE: Option US1

Adds SDH STM-1 electrical transmit and receive capability, frequency offset capability, and error and alarm generation.

SDH Transmit and Receive

SDH rate: 155.52 Mb/s

Frequency Offset: up to ± 999 ppm.

Interface: Meets ITU-T G.703.

Connector: BNC, 75 unbalanced.

Payload:

140 Mb/s: Unframed, mapped into VC-4 according to ITU-T G.709 Figures 5.2 and 5.3.

34 Mb/s: Unframed, mapped into VC-3 according to ITU-T G.709 Figure 5.5. Mapping route is C3-VC-3-TU-3-TUG3-VC-4.

The TU-3 pointer value is 0 with normal New Data Flag in all TU-3's. SS bits "10". Background TU pointers are the same as the foreground. The two background VC-3's are filled with a fixed byte value 10101010

2 Mb/s: Unframed, mapped into VC-12 according to ITU-T G.709 Figure 5.8. Mapping route is C12-VC-12-TU-12-TUG2-TUG3-VC-4.

All background TU-12's have mapped 2^9-1 PRBS payload and the same overhead values as the foreground.

Test patterns:

PRBS: $2^{15}-1$, $2^{23}-1$ at all payload rates (ITU-T O.151).

Word: User-defined 16 bit word, all ones, all zeros, 1010, 1000.

Bit error add: 1 in 10^3 or single error.

Clock timing: Internal or recovered or external MTS.

Recovered: From received SDH signal.

EXT MTS: Data or clock format as ITU-T G.811.

TX Overhead

Regenerator section overhead:

A1A2 contains pattern F628 (hexadecimal)

C1 is set to "00000001".

B1 is the BIP-8 parity (using even parity) calculated over the entire previous frame, after scrambling.

E1 is transmitted as all zeros.

F1 is transmitted as all zeros.

D1-D3 are transmitted as all zeros.

All other bytes are all zero's.

Multiplexer section overhead:

H1,H2 - H2 and the 2 least significant bits of H1 indicate an in-range pointer value. The 4 most significant bits of H1 are set to 0110 indicating normal New Data Flag. The SS bits are set to 10.

H3 is transmitted as all zeros.

B2 is the BIP-24 parity (using even parity) calculated over the MSOH bytes and the VC-4 capacity.

K1,K2 are transmitted as all zeros.

D4 - D12 are transmitted as all zeros.

Z1,Z2 are transmitted as all zeros.

E2 is transmitted as all zeros.

All other bytes are all zero's.

General Information

Specifications

User programmable

K1,K2 - Can only program 1 byte at a time i.e. K1 or K2.

S1 - Bits 5 - 8 only.

VC-4 path overhead:

J1 - a unique ASCII message is transmitted: "HP37717C

COMMUNICATIONS PERFORMANCE ANALYZER, GB00000000". Terminated by CR,LF. B3 is the BIP-8 parity (using even parity) calculated over the previous VC-4,before scrambling.

C2 is transmitted as Hexadecimal 12 (140 Mb/s Mapping) or 02 (2 Mb/s & 34 Mb/s Mapping),

G1 is transmitted as all zeros.

F2 is transmitted as all zeros.

H4 is transmitted as all zeros unless a TU-12 payload is selected, in which case the reduced H4 sequence defined in ITU-T Rec. G.709 is transmitted.

Z3 - Z5 are transmitted as all zeros.

All other bytes are all zero's.

VC-3 path overhead:

J1 - a unique ASCII message is transmitted: "HP37717C

COMMUNICATIONS PERFORMANCE ANALYZER, GB00000000". Terminated by CR,LF. B3 is the BIP-8 parity (using even parity) calculated over the previous VC-3,before scrambling.

C2 is transmitted as Hexadecimal 04 (34 Mb/s mapping).

G1 is transmitted as all zeros.

F2 is transmitted as all zeros.

H4 is transmitted as all zeros.

Z3 - Z5 are transmitted as all zeros.

All other bytes are all zeros.

TU-12 overhead: V1,V2 - V2 and the 2 least significant bits of V1 are 0 indicating a pointer value of 0. The 4 most significant bits of V1 are 0110 indicating normal New Data Flag. The SS bits are 10 indicating TU-12 payload. \

V5 - Bits 1 and 2 are the BIP-2 parity of the previous VC-12 including V5 but excluding V1 - V4. The VC-12 spans 4 frames.

Bits 5 - 7 are set to 010 indicating Async mapping. All other bits are set to 0.

Pointer detection AU-4 pointer value, TU-3 pointer value and TU-12 pointer value.

Alarm generation

Loss of frame (LOF) STM-1 Only, AU-4 Loss Of Pointer (AU-4 LOP), Multiplexer Section (MS AIS), Multiplexer Section FERF (MS FERF), AU-4 Path AIS, AU-4 Path FERF, TU-3 Path AIS, TU-3 Path FERF, TU-3 LOP, TU-12 Path AIS, TU-12 Path FERF and TU-12 LOP.

Equalization: Automatic for cable loss up to 12 dB at half the bit rate.

Monitor point compensation: 20 dB

General Information
Specifications

Error Generation			
Error type	Single	Rate 10^{-N}	Other
Frame A1A2	*		N in 4 frame words (STM-1 Only)
B1	*	4 - 9	STM-1 Only
B2	*	3 - 9	STM-1 Only
B3	*	4 - 9	
Path FEBE	*	4 - 9	
VC-3 Path BIP	*	3 - 9	
VC-3 Path FEBE	*	3 - 9	
V5 BIP-2	*	3 - 9	
V5 FEBE	*	4 - 9	
Payload Bit	*	3 - 9	

Option A3R

**OUT and IN ports
(used for transmit)**

Type: Electrical: To ITU-T G.703.

Connectors: BNC, 75 Ω unbalanced.
(Small Siemens 75 Ω unbalanced
option available.)

Rate: 155.52 Mb/s. 51.84 Mb/s.

Line code: 155.52 Mb/s: CMI. 51.84
Mb/s: B3ZS.

Output level: 155.52 Mb/s: ± 0.5 V
 $\pm 10\%$. 51.84 Mb/s: Output level is user
configurable.

STM-0 X CON: 530 mV peak nominal.

STM-0 HI: 1.1 V peak nominal.

STM-0 LOW: 350m V peak
nominal.

Error output: B3 error output pulse on

receipt of STM-0 and STM-1 signals.
TTL pulse termination 75 Ω or 10 k Ω .

**Simultaneous STM-1e/STM-1e
and STM-1o:**

When used in
conjunction with the appropriate optical
interfaces, transmit STM-1 electrical
output signal simultaneously with
optical output signal.

Transmitter

Clock timing: Internal: All rates.

Recovered: From SDH input (CMI or
NRZ electrical or optical).

Ext MTS: 64 kb/s conforming to ITU-T

G.703, 2 Mb/s conforming to ITUT-

G.811. BNC, 75 Ω unbalanced or

Siemens (3-pin), 120 Ω balanced.

(Siemens (3-pin) connector is present

on option A3R. Option 120 replaces

this connector with a Bantam

connector).

General Information

Specifications

Frequency offset generation:

Up to ± 999 ppm in 0.1 ppm steps.

Error addition:

Error type	Single	Rate 10^{-N}	Comments
Frame A1A2	*		N in 4 frame words
B1	*	4 - 9	
B2	*	3 - 9	
MS REI	*	3 - 9	
AU-4 path BIP-8 (B3)	*	4 - 9	
AU-4 path REI	*	4 - 9	
AU-4 path IEC	*	4 - 9	
AU-3 path BIP-8 (B3)	*	4 - 9	
AU-3 path REI	*	4 - 9	
AU-3 path IEC	*	4 - 9	
TU-3 path BIP-8 (B3)	*	3 - 9	
TU-3 path REI	*	3 - 9	
TU-2 path BIP (V5)	*	4 - 9	
TU-2 path REI	*	5 - 9	
TU-12 path BIP (V5)	*	3 - 9	
TU-12 path REI	*	4 - 9	
TU-11 path BIP		3 - 9	
TU-11 path REI		4 - 9	
Bit error *	*	3 - 9	

† MSP threshold N errors in T ms where $0 \leq N \leq 1920$ (STM-1) and 10 ms $\leq T \leq 10000$ s, in decade steps.

* For SDH stand-alone operation, bulk-filled payloads and DS1, DS3 mapped payloads only. For bit error rates supported with other payloads refer to the PDH test option for details

General Information

Specifications

Alarm generation:

LOS, LOF, OOF, MS AIS, MS RDI, AU-4 path AIS, AU-4 path RDI, AU-4 LOP, AU-4 path unequipped, AU-3 path AIS, AU-3 path RDI, AU-3 LOP, AU-3 path unequipped, TU-3 path AIS, TU-3 path RDI, TU-3 LOP, TU-3 path unequipped, TU-2 path AIS, TU-2 path RDI, TU-2 LOP, TU-2 path unequipped, TU-2 H4 LOM (loss of multiframe), TU-12 path AIS, TU-12 path RDI, TU-12 LOP, TU-12 path unequipped, TU-12 H4 LOM (loss of multiframe), TU-11 path AIS, TU-11 path RDI, TU-11 LOP, TU-11 path unequipped, TU-11 H4 LOM (loss of multiframe).

Payload capability

STM-1/STM-4 payload mappings (to ITU-T G.707):

139.264 Mb/s into a VC-4 and VC-4 bulk-filled mappings. 34.368 Mb/s into VC-3 and VC-3 bulk-filled mappings. 2.048 Mb/s (async and fl. byte sync) into VC-12 and VC-12 bulk-filled mappings.

DS3 (44.736 Mb/s) into VC-3 and VC-3 bulk-filled mappings

DS1 (1.544 Mb/s) async into VC11†.

VC-3 - TU-3 - TUG-3 - VC-4 - AU-4 - AUG; VC-3 - AU-3 - AUG.

VC-2 bulk filled mapping and TU-2-Nc (for N = 2 to 6): VC-2 - TU-2 - TUG-2 - TUG-3 - VC-4 - AU-4 - AUG

VC-2 - TU-2 - TUG-2 - VC-3 - AU-3 - AUG.

VC-12 - TU-12 - TUG-2 - TUG-3 -

VC-4 - AU-4. VC-12 - TU-12 - TUG-2 - TUG-3 - VC-3 - AU-3 - AUG.

VC-11 - TU-11 - TUG-2 - TUG-3 -

VC-4 - AU-4 - AUG. VC-11 - TU-11 - TUG-2 - VC-3 - AU-3 - AUG

† *DS1 and DS3 mappings require PDH options UKJ, UKN or 110 to be fitted.*

Payload data: The following unframed patterns can be generated: (Framed and structured signals are available in conjunction with the PDH/DSn option UKJ/UKN/110).

PRBS: 2⁹-1 (O.150), 2¹¹-1 (O.152), 2¹⁵-1 (O.151) and 2²³-1 (O.151)

QRSS (2²⁰-1, 14 zero limited)†

Word: User-defined 16-bit word, all ones, all zeros, 1010, 1000. All PRBS patterns can be set to inverted or non-inverted.

† *Applicable to DS1 mappings only.*

Payload framing: 139.264, 34.368 and 2.048 Mb/s: Unframed.

139.264, 34.368 and 2.048 Mb/s:

Framed and structured.†

DS3† payloads: Unframed, C-Bit parity (to ANSI T1.107a-1990) M13 (to ANSI T1.107-1988).

TU-2: Unframed. DS1† payloads:

Unframed, SF (D4), ESF (to ANSI T1.403-1989, TR-TSY-000499 and ITU-T G.704), SLC-96.

† *Only available in conjunction with the PDH/DSn option UKJ/UKN/110.*

Drop/insert: 139.264 Mb/s: Drop/insert via Tx/Rx on options UKJ/UKN.

45.736 (DS3): Drop/insert via Tx/Rx on option 110.

34.368 Mb/s: Drop/insert via Tx/Rx on options UKJ/UKN/110.

2.048 Mb/s: Drop/insert via drop/insert ports on options UKJ/UKN/110.

General Information

Specifications

1.544 Mb/s: Drop/insert via drop/insert ports on option 110.

Pointer adjustment generation

Increment/decrement/alternating:

Provides a burst, selectable between 1 and 10 pointer adjustments (between 1 and 5 for TU-12 or TU-11 pointer).

New pointer value: The AU-4, AU-3, TU-3, TU-2, TU-12 or TU-11 moves to a selectable new location in a single jump, with or without an accompanying new data flag (NDF).

Frequency offset (and 87:3):

Pointer sequences are generated by offsetting the frequencies of the AU-4, AU-3 (in these modes the 87:3 sequence is generated to ITU-T G.783) or TU-3, TU-2, TU-12, TU-11 and the line rate relative to each other. Range: ± 100 ppm in 0.1 ppm steps.

ITU-T G.783 sequences: Bursts of periodic single adjustments with added or canceled adjustments. Polarity is selectable. Bursts of periodic double adjustments with pairs alternating in polarity. In all cases the interval between adjustments or pairs of adjustments is programmable. On starting to run any of the pointer sequences an initialization sequence followed by a cool down period may be run prior to the chosen sequence.

Transmit overhead

Overhead: Default selection: Standard overhead values to ITU-T G.707.

SOH user-settable bytes: SOH can be set in binary or HEX. RSOH: A1, A2, J0, E1, F1, D1 to D3. J0 path trace:

User-defined/predefined 16-byte ITU-T E.164 sequence. MSOH: K1, K2, D4 to D12, S1, M1, Z1[†], Z2[†], E2 (and access to bytes reserved for national use plus all bytes reserved for future international standardization). VC-4 and VC-3 POH: J1, C2, G1, F2, H4, F3, K3, N1. J1 path trace: User-defined/predefined 16-byte ITU-T E.164 sequence or 64-byte sequence. VC-2, VC-12, VC-11 POH: V5, J2, N2, K4. J2 path trace: User defined/predefined 16-byte ITU-T E.164 sequence.

[†] Z1 and Z2 are not present in STM-0 mode.

Overhead sequence generation:

A single or multi-byte overhead channel is overwritten with a single or repeated sequence of programmed values. The sequence can contain up to five different values each being transmitted for up to 64,000 frames.

RSOH:

6-byte channel A1A2

3-byte channel D1 to D3

Single byte channels: C1, E1, F1.

MSOH:

9-byte channel D4 to D12

2-byte channel K1K2.

Single byte channels: S1, M1, Z1[†], Z2[†], E2.

[†] Z1 and Z2 are not present in STM-0 mode.

High order POH:

Single byte channels: J1, C2, G1, F2, H4, F3, K3, N1.

Overhead BER test: Any RSOH, MSOH or POH (except A1, A2, H1, H2, Z1, Z2) channel is selected and a

General Information

Specifications

BER measurement is performed using a 2^9-1 PRBS inserted into a 64 kb/s channel. Single errors can be added to the test pattern.

MSP message generation:

Messages are displayed in text form as per ITU-T G.783 for linear architecture and to ITU-T G.841 for ring architectures (MSP-ring). User programmed sequences (K1K2).

DCC drop/insert: The data supplied to the DCC port can be inserted into either the regenerator section or multiplexer section data communications channel. Similarly, data can be dropped from either channel. The data may be dropped/inserted MSB or LSB first. The data rate for access is: 192 kb/s (RSOH DCC), 576 kb/s (MSOH DCC).

Optical interface stress test:

2 to 259 bytes of the payload are overwritten with a block of zeros or ones after scrambling. Alternatively the ITU-T G.958 CID (consecutive identical digits) test can be selected.

Tributary scan: Automatically test BER on each SDH tributary for error free operation. Rx setup is used to determine tributary structure and test pattern. Alarms: Pattern loss. Test time: Fully user selectable. User selectable bit error threshold: Off, > 0, $\geq 10^{-3}$, $\geq 10^{-6}$.

Mixed payloads: Backgrounds can be individually configured to have TU-11, TU-12 or TU-3 independently for foreground testing channel.

Keep alive signals: PDH: Transmit last configured SDH signal while

transmitting a PDH signal.

SDH: With structured PDH options transmit unframed fixed word PDH signal while transmitting an SDH signal.

SDH: Using unstructured PDH option transmit last configured PDH signal while transmitting an SDH signal.

Thru mode

Transparent thru mode: The signal is passed through the instrument without being altered for monitoring purposes where no protected monitor point is available.

Overhead overwrite thru mode:

In addition to the above, the test features associated with the SOH and POH can be enabled to control one single- or multi-byte overhead channel (i.e. errors and alarms, optical stress test, overhead sequences, MSP messages, DCC insert, overhead BER. Full Rx functionality also available).

AU-4/AU-3 overwrite thru mode:

In addition to both of the above, overwrite the complete AU-4/AU3 with the internally generated payload. This enables the SOH to be looped through while a new payload is inserted. All of the test features which affect the VC-4/VC-3 and/or the POH are enabled (i.e. errors and alarms, adjust pointer, overhead sequences, MSP messages, overhead BER. Full Rx functionality also available).

Tributary overwrite thru mode:

When the payload passing through the instrument contains a TU structure, thru mode it will be possible to choose a

General Information

Specifications

single TU to be overwritten, as opposed to the complete payload. All of the test features which affect the TU and/or the POH are enabled (i.e. errors and alarms, adjust pointer. Full Rx functionality also available).

STM-1e and STM-0/STM-1e receiver functions

STM-1 receive input

Equalization: Automatic for cable loss up to 12 dB at half the bit rate.

Monitor point compensation: Monitor mode conforms to ITU-T G.772. Monitor gain 20 to 26 dB.

STM-0 receive input

Operating level: Receiver mode is user selectable.

STM-0 XCON: 530 mV peak nominal
STM-0 HI: 1.1 V peak nominal, equalization up to 450 ft.

STM-0 LOW: 1.1 V peak nominal, equalization from 450 to 900 ft.

Monitor point compensation: Monitor mode conforms to ITU-T G.772. Monitor gain 20 to 26 dB.

STS-3/STM-1e and STM-0/STM-1e test and interfacing (Option 120)

(for SDH specification see A3R)

OUT and IN ports (used for transmit)

Type: Electrical: To ITU-T G.703.

Connectors: BNC, 75 Ω , unbalanced.

Rate: 155.52 Mb/s. 51.84 Mb/s.

Line code: 155.52 Mb/s: CMI.
51.84 Mb/s: B3ZS.

Output level: 155.52 Mb/s: ± 0.5 V $\pm 10\%$. 51.84 Mb/s: Output level is user configurable.

STS-1 X CON: 530 mV peak nominal.

STS-1 HI: 1.1 V peak nominal.

STS-1 LOW: 350m V peak nominal.

Error output: B3 error output pulse on receipt of STS-1 and STS-3 signals.
TTL pulse termination 75 Ω or 10 k Ω .

Simultaneous STS-3 and OC-3:

When used in conjunction with the appropriate optical interfaces, transmit STS-3 electrical output signal simultaneously with OC-3 optical output signal.

Transmitter

Clock timing: Internal: All rates.

Recovered: From SONET input (CMI or NRZ electrical or optical)

Bits: 1.544Mb/s DS1 timing reference as per TA-TSY-000378 Bantam, 100 Ω nominal, unbalanced

Ext MTS: 64kb/s conforming to ITU-T G.703, Bantam, 120 Ω balanced*

2 Mb/s conforming to ITU-T G.811,

BNC 75 Ω unbalanced,*

Bantam 120 Ω balanced.*

* Available when instrument in SDH mode.

Frequency offset generation:

Up to ± 999 ppm in 0.1 ppm steps.

Error addition:

General Information
Specifications

Error type	Single	Rate 10 ^{-N}	Comments
Frame A1A2	*		N in 4 frame words
CV-S (B1)	*	4 - 9	
CV-2 (B2)	*	3 - 9	
REI-L	*	3 - 9	
STS-3c SPE CV-P (B3)	*	4 - 9	
STS-3c SPE REI-P	*	4 - 9	
STS-3c SPE IEC-P	*	4 - 9	
STS-1 SPE CV-P (B3)	*	4 - 9	
STS-1 SPE REI-P	*	4 - 9	
STS-1 SPE IEC-P	*	4 - 9	
VT6 CV-P (V5)	*	4 - 9	
VT6 REI-P	*	5 - 9	
VT2 CV-P (V5)	*	3 - 9	
VT2 REI-P	*	4 - 9	
VT1.5 CV-P	*	3 - 9	
VT1.5 REI-P	*	4 - 9	
Bit error *	*	3 - 9	

† APS threshold N errors in T ms where $0 \leq N \leq 1920$ (STM-3) and $10 \text{ ms} \leq T \leq 10000 \text{ s}$, in decade steps.

* For SONET stand-alone operation, bulk-filled payloads and DS1, DS3 mapped payloads only.

For bit error rates supported with other payloads refer to the DSn/PDH test option for details.

Alarm generation: LOS, LOF, SEF, AIS-L, RDI-L.

STS-3c SPE AIS-P, STS-3c SPE RDI-P, STS-3c SPE LOP, STS-3c SPE path unequipped.

STS-1 SPE AIS-P, STS-1 SPE RDI-P, STS-1 SPE LOP, STS-1 SPE path unequipped.

VT6 path AIS, VT6 RDI-V, VT6 LOP, VT6 path unequipped, VT6 H4 LOM (loss of multiframe).

VT2 path AIS, VT2 RDI-V, VT2 LOP, VT2 path unequipped,

General Information

Specifications

VT2 H4 LOM (loss of multiframe).
VT1.5 path AIS, VT1.5 RDI-V, VT1.5
LOP, VT1.5 path unequipped
VT1.5 H4 LOM (loss of multiframe).

Payload capability

Payload mappings (to Bellcore GR-253-CORE):

OC-12/OC-12c/OC-3/OC-3c
capability when optical module fitted.
DS3(44.736 Mb/s) into STS-1 SPE and
STS-1 SPE bulk filled mappings:
DS1(1.544Mb/s) async into VT1.5.
139.264 Mb/s into a STS-3c SPE and
STS-3c SPE bulk-filled mappings.
2.048 Mb/s (async and fl. byte sync)
into VT2 SPE and VT2 SPE bulk filled
mappings:
34.368 Mb/s, into STS-1 SPE and STS-
1 SPE bulk filled mappings:
VT6 SPE bulk filled mapping and VT6
-Nc (for N = 2 to 6):

† DS1, DS3 mappings require DS_n/
PDH option UKJ, UKN or 110 to be
fitted.

Payload data: The following unframed
patterns can be generated: (Framed and
structured signals are available in
conjunction with the PDH/DS_n options
UKJ/UKN/110).

PRBS: 2⁹-1 (O.150), 2¹¹-1 (O.152),
2¹⁵-1 (O.151) and 2²³-1 (O.151)

QRSS (2²⁰-1, 14 zero limited)†

Word: User-defined 16-bit word, all
ones, all zeros, 1010, 1000. All PRBS
patterns can be set to be inverted or
non-inverted.

† Applicable to DS1 mappings only.

Payload framing: 139.264, 34.368 and
2.048 Mb/s: Unframed.

139.264, 34.368 and 2.048 Mb/s:
Framed and structured signals†
DS3 payloads: Unframed, C-Bit parity
(to ANSI T1.107a-1990)†
M13 (to ANSI T1.107-1988).
VT6: Unframed. DS1 payloads:
Unframed, SF (D4), ESF (to ANSI
T1.403-1989, TR-TSY-000499 and
ITU-T G.704), SLC-96†.

† Only available in conjunction with
the PDH/DS_n option UKJ/UKN/110.

Drop/insert: 139.264Mb/s: Drop/insert
via Tx/Rx on options UKJ/UKN.
45.736 (DS3): Drop/insert via Tx/Rx
on option 110.
34.368 Mb/s: Drop/insert via Tx/Rx on
options UKJ/UKN/110.
2.048 Mb/s: Drop/insert via drop/insert
ports on options UKJ/UKN/110.
1.544 Mb/s (DS1): Drop/insert via
drop/insert ports on option 110.

Pointer adjustment generation

Increment/decrement/alternating:

Provides a burst, selectable between 1
and 10 pointer adjustments (between 1
and 5 for VT6, VT2 and VT1.5
pointer).

New pointer value: The STS-3c SPE,
STS-1 SPE, VT6, VT2 or VT1.5 moves
to a selectable new location in a single
jump, with or without an accompanying
new data flag (NDF).

Frequency offset (and 87:3):

Pointer sequences are generated by
offsetting the frequencies of the STS-3c
SPE, STS-1 SPE (in these modes the
87:3 sequence is generated to Bellcore
GR-253-CORE/ANSI T1.105.03) or
VT6, VT2, VT1.5 and the line rate

General Information

Specifications

relative to each other.

Range: ± 100 ppm in 0.1 ppm steps.

Bellcore GR-253-CORE and

ANSI T1.105.03: Bursts of periodic single adjustments with added or canceled adjustments. Polarity is selectable. Bursts of periodic double adjustments with pairs alternating in polarity. In all cases the interval between adjustments or pairs of adjustments is programmable.

On starting to run any of the pointer sequences an initialization sequenced followed by a cool down period may be run prior to running the chosen sequence.

Transmit overhead

Overhead: Default selection: Standard overhead values to Bellcore GR-253-CORE. and ANSI T1.05

STS-3/STS-1 user-settable bytes:

TOH can be set in binary or HEX.

SOH: A1, A2, J0, E1, F1, D1 to D3.

J0 path trace: User-defined/predefined 16-byte ITU-T E.164 sequence.

LOH: K1, K2, D4 to D12, S1, M1, E2 (and access to bytes reserved for national use plus all unmarked bytes reserved for future international standardization).

STS-1 SPE POH: J1, C2, G1, F2, H4, Z3, Z4, N1.

J1 path trace: User-defined/predefined 16-byte ITU-T E.164 sequence or 64-byte sequence.

VT6 SPE, VT2 SPE, VT1.5 SPE POH: V5, J2, Z6, Z7.

J2 path trace: User defined/predefined 16-byte ITU-T E.164 sequence.

Overhead sequence generation:

A single or multi-byte overhead channel is overwritten with a single or repeated sequence of programmed values. The sequence can contain up to five different values each being transmitted for up to 64,000 frames.

SOH:

6-byte channel A1A2

3-byte channel D1 to D3

Single byte channels: C1, E1, F1.

LOH:

9-byte channel D4 to D12

2-byte channel K1K2

Single byte channels: S1, M1, Z1†, Z2†, E2.

† Z1 and Z2 are not present in STS-1 mode.

High order POH:

Single byte channels: J1, C2, G1, F2, H4, Z3, Z4, N1.

Overhead BER test: Any SOH, LOH or POH (except A1, A2, H1, H2, Z1, Z2) channel is selected and a BER measurement is performed using a 2^9-1 PRBS inserted into a 64 kb/s channel. Single errors can be added to the test pattern.

APS message generation: Messages are displayed in text form as per Bellcore GR-253-CORE for linear architecture and to Bellcore GR-1230-CORE for ring architectures (BLSR). User programmed sequences (K1K2).

DCC drop/insert: The data supplied to the DCC port can be inserted into either the regenerator section or multiplexer section data communications channel. Similarly, data can be dropped from

General Information

Specifications

either channel. The data may be dropped/inserted MSB or LSB first. The data rate for access is: 192 kb/s (SOH DCC), 576 kb/s (LOH DCC).

Optical interface stress test:

2 to 259 bytes of the payload are overwritten with a block of zeros or ones after scrambling. Alternatively the ITU-T G.958 CID (consecutive identical digits) test can be selected.

Tributary scan: Automatically test BER on each SONET tributary for error free operation.

Rx setup is used to determine tributary structure and test pattern.

Alarms: Pattern loss.

Test time: Fully user selectable.

User selectable bit error threshold: Off, > 0, $\geq 10^{-3}$, $\geq 10^{-6}$.

Mixed payloads: Each STS-1 SPE within an STS-3 can be independently configured to contain a STS-1 SPE user word, VT2 or VT1.5 structure.

Keep alive signals: DSn/PDH:

Transmit last configured SONET signal while transmitting a DSn/PDH signal.

Thru mode

Transparent thru mode:

The signal is passed through the instrument without being altered for monitoring purposes where no protected monitor point is available.

Overhead overwrite thru mode:

In addition to the above, the test features associated with the TOH and POH can be enabled to control one single- or multi-byte overhead channel

(i.e. errors and alarms, optical stress test, overhead sequences, APS messages, DCC insert, overhead BER. Full Rx functionality also available).

STS-3c/STS-1 SPE overwrite

thru mode: In addition to both of the above, overwrite the complete SPE with the internally generated payload. This enables the TOH to be looped through while a new payload is inserted. All of the test features which affect the SPE and/or the POH are enabled (i.e. errors and alarms, adjust pointer, overhead sequences, APS messages, overhead BER. Full Rx functionality also available).

Tributary overwrite thru mode:

When the payload passing through the instrument contains a VT structure, thru mode it will be possible to choose a single VT to be overwritten, as opposed to the complete payload. All of the test features which affect the VT and/or the POH are enabled (i.e. errors and alarms, adjust pointer. Full Rx functionality also available).

STS-3 and STS-1 receiver functions

STS-3 receive input

Equalization: Automatic for cable loss up to 12 dB at half the bit rate.

Monitor point compensation:

Monitor mode conforms to ITU-T G.772. Monitor gain 20 to 26dB.

STS-1 receive input

General Information

Specifications

Operating level:

Receiver mode is user selectable.
STS-1 XCON: 530 mV peak nominal.
STS-1 HI: 1.1 V peak nominal, equalization up to 450 ft.
STS-1 LOW: 1.1 V peak nominal, equalization from 450 to 900 ft.

Monitor point compensation:

Monitor mode conforms to ITU-T G.772. Monitor gain 20 to 26 dB.

OVERHEAD and STRESS TEST SDH MODULE:

Option A1T.

Adds SDH STM-1 electrical transmit and receive capability, frequency offset capability, error and alarm generation, pointer sequence generation and overhead access.

SDH Transmit and Receive

SDH rate: 155.52 Mb/s

Frequency Offset: up to 999 ppm.

Interface: Meets ITU-T G.703

Connector: BNC, 75 Ω unbalanced.

Clock timing: Internal or recovered or external MTS.

Recovered: From received SDH signal.

EXT MTS: Data or clock format as ITU-T G.811.

Payload capability:

Payload mappings: 139.264 Mb/s mapped into VC-4 according to ITU-T G.709.

34.368 Mb/s mapped into VC-3 according to ITU-T G.709.

2.048 Mb/s (asynchronous) mapped into VC-12 according to ITU-T G.709.

2.048 Mb/s (Floating byte synchronous) mapped into VC-12 according to ITU-T G.709.
VC-2 bulk loaded and mapped into TU-2 and TU-2-Nc (for N = 2-6) according to ITU-T G.709.

Payload Data:

PRBS: 2⁹-1, 2¹¹-1, 2¹⁵-1, 2²³-1 (ITU-T O.151).

Word: User-defined 16 bit word, all ones, all zeros, 1010, 1000.

Framed and structured payloads are available in conjunction with the Structured PDH option UKJ/UKN.

Payload framing: 139.264, 34.368, and 2.048 Mb/s and TU-2 Unframed. 139.264, 34.368, and 2.048 Mb/s framed and structured signals are available in conjunction with the Structured PDH option UKJ/UKN.

External payload data: 139.264 and 34.368 Mb/s data may be inserted and dropped via the IN/OUT ports of the Structured PDH option UKJ/UKN. 2.048 Mb/s data may be inserted and dropped via the 2 Mb/s drop/insert ports of the Structured PDH option UKJ/UKN.

TX Overhead User programmable bytes:

RSOH: A1,A2, C1, E1, F1, D1 to D3 and access to bytes reserved for national use plus all unmarked bytes reserved for future international standardization.

MSOH: K1, K2, D4 to D12, S1, M1, Z1, Z2, E2 and access to bytes reserved for national use plus all unmarked bytes reserved for future international standardization.

General Information

Specifications

VC-4 and VC-3 POH: J1, C2, G1, F2, H4, Z3 to Z5.

J1 Path Trace: 64 byte or 16 byte, ITU-T E.164 sequence or user defined byte.

VC-12 POH: J2, V5 signal label.

J2 Path Trace: 16 byte ITU-T E.164 sequence or user defined byte.

Pointer adjustment generation:

Increment/Decrement: The adjust pointer key provides a burst selectable between 1 and 10 pointer adjustments (between 1 and 5 for TU-12 and TU-2 pointer).

Frequency offset: these 87:3 pointer sequences are generated by offsetting the frequencies of the AU-4 (or TU-3, TU-12, TU-2) and the line rate relative

to each other. Range: 100 ppm in 0.1 ppm steps.

New pointer value: The AU-4, TU-3, TU-12 or TU-2 moves to a selectable new location in a single jump, with or without an accompanying new data flag (NDF).

ITU-T G.783 sequences: Bursts of periodic single adjustments with added or cancelled adjustments. Polarity is selectable.

Bursts of periodic double adjustments with pairs alternating in polarity.

In all cases the interval between adjustments or pairs of adjustments is programmable.

Error Generation			
Error type	Single	Rate 10 ^{-N}	Other
Frame A1A2	*		N in 4 frame words (STM-1 Only)
B1	*	4 - 9	STM-1 Only
B2	*	3 - 9	STM-1 Only
AU-4 Path BIP-8	*	4 - 9	
MS FEBE	*	3 - 9	
AU-4 Path FEBE	*	4 - 9	
AU-4 Path IEC	*	4 - 9	
TU-3 Path BIP-8	*	3 - 9	
TU-3 Path FEBE	*	3 - 9	
TU-2 Path BIP	*	4 - 9	
TU-2 Path FEBE	*	5 - 9	
TU-12 BIP	*	3 - 9	

General Information
Specifications

Error Generation			
Error type	Single	Rate 10 ^{-N}	Other
TU-12 FEBE	*	4 - 9	
Payload Bit	*	3 - 9	

Alarm generation Loss of signal (LOS), Loss of frame (LOF) STM-1 Only, Out of frame (OOF), AU-4 Loss Of Pointer (AU-4 LOP), AU-4 path unequipped, AU-4 Path AIS, AU-4 Path FERF, Multiplexer Section AIS (MS AIS), Multiplexer Section FERF (MS FERF), TU-3 Path AIS, TU-3 path unequipped, TU-3 Path FERF, TU-3 LOP, TU-2 path AIS, TU-2 path FERF, TU-2 LOP, TU-2 path unequipped, TU-12 path unequipped, TU-12 Path AIS, TU-12 Path FERF and TU-12 LOP.

Overhead sequence generation: A single overhead channel is overwritten with a single or repeated sequence of programmed values. Alternatively a BER test can be performed on a selected byte of regenerator, multiplexer section or path overhead.

MSP message generation: Messages are displayed in text form as per ITU-T G.783. Also user programmed sequences.

DCC insert/drop: Data supplied to the DCC port can be inserted into either the regenerator section (192 kb/s) or multiplexer section (576 kb/s) communications channel. Similarly, data can be dropped from either. Data may be inserted/dropped MSB or LSB first.

STM-1 optical interface stress test: 2 to 259 bytes of the payload are overwritten with a block of zeros (or ones for NRZ systems) after scrambling. Alternatively the ITU-T G.958 test can be selected.

STM-1 thru mode:

Transparent mode: The signal is passed through the instrument unaltered.

Overhead overwrite mode: The test features associated with MSOH and POH can be enabled in order to control one single or multi byte overhead channel.

AU-4 overwrite mode: Overwrite the complete AU-4 with the internally generated payload. This enables the SOH to be looped through while a new payload is inserted. All of the test features which affect the VC-4 and/or the POH are enabled.

Equalization: Automatic for cable loss up to 12 dB at half the bit rate.

Monitor point compensation: 20 or 26 dB

Pointer detection: AU-4, TU-3 and TU-12 pointer values.

General Information

Specifications

STM-1 OPTICAL INTERFACE:

Option UH1.

Rate: 155.52 Mb/s

Line code: NRZ

Connectors: Adaptors to which a range of interfaces can be attached.

Transmit:

Wavelength: 1280 - 1330 nm

Fibre power output: nominal -9 dBm

Safety classification: Class 1, FDA 21 CFR Ch.1 1040.10 and EN 60825

Receive:

Wavelength: 1200 - 1600 nm

Sensitivity: -28 dB minimum (with 1300 nm wavelength, 100% modulation depth, BER of 10^{-10} and 2^{23} PRBS)

Maximum input power: -8 dBm (for BER of 10^{-10})

Alarms detected: Loss of optical signal.

STM-1/STM-4 OPTICAL INTERFACE: Option UH2.

Rate: 155.52 Mb/s, 622.08 Mb/s

Line code: NRZ

Connectors: Adaptors to which a range of interfaces can be attached.

Transmit:

Wavelength: 1280 - 1330 nm

Fibre power output: nominal -10 dBm

Safety classification: Class 1, FDA 21 CFR Ch.1 1040.10 and EN 60825

Receive:

Wavelength: 1200 - 1600 nm

Sensitivity: -26 dB minimum (with 1300 nm wavelength, 100% modulation depth, BER of 10^{-10} and 2^{23} PRBS)

Maximum input power: -8 dBm (for BER of 10^{-10})

Alarms detected: Loss of optical signal.

Background STM-1 overhead:

A1,A2 contains pattern F628 (hexadecimal)

C1 - 00000001 to 00000100

Unused C1 bytes - AA (hexadecimal)

B1 - Correct BIP-8 parity

H1,H2 - 6A and 0A (hexadecimal), Y=93 (hexadecimal)

B2 - Correct BIP-24 parity

B3 - Correct BIP-8 parity

H4 is transmitted as all zeroes unless a TU-12 payload is selected, in which case the reduced H4 sequence defined in ITU-T Rec. G.709 is transmitted.

All other overhead bytes are transmitted as all zero's.

STM-1/STM-4 OPTICAL INTERFACE: Option URU.

Rate: 155.52 Mb/s, 622.08 Mb/s

Line code: NRZ

Connectors: Adaptors to which a range of interfaces can be attached.

Transmit:

Wavelength: 1520 - 1565 nm

Fibre power output: nominal -1 dBm

Safety classification: Class 1, FDA 21 CFR Ch.1 1040.10 and EN 60825

Receive:

Wavelength: 1200 - 1600 nm

Sensitivity: -26 dB minimum (with 1300 nm wavelength, 100% modulation depth, BER of 10^{-10} and 2^{23} PRBS)

Maximum input power: -8 dBm (for BER of 10^{-10})

Alarms detected: Loss of optical signal.

General Information

Specifications

Background STM-1 overhead:

A1,A2 contains pattern F628
(hexadecimal)

C1 - 00000001 to 00000100

Unused C1 bytes - AA (hexadecimal)

B1 - Correct BIP-8 parity H1,H2 - 6A
and 0A (hexadecimal), Y=93
(hexadecimal)

B2 - Correct BIP-24 parity

B3 - Correct BIP-8 parity

H4 is transmitted as all zeroes unless a
TU-12 payload is selected, in which
case the reduced H4 sequence defined
in ITU-T Rec. G.709 is transmitted.

All other overhead bytes are
transmitted as all zero's.

Protected monitor point input:

Level: nominal 150 mV to 800 mV pk-
pk

STM-1/STM-4 OPTICAL INTERFACE (1310 nm) with STM-4 Overhead Option UKT

Rate: 155.52 Mb/s, 622.08 Mb/s

Line code: NRZ

Connectors: Adaptors to which a range
of interfaces can be attached.

Transmit:

Wavelength: 1280 - 1330 nm

Spectral width: 2.5 nm rms nominal

Extinction ratio: <8.2dB nominal

Fibre power output: -10dBm nominal

Safety classification: Class 3A, FDA
21 CFR Ch.1 1040.10 and EN 60825

Clock timing: Internal, recovered from
received STM-1 or STM-4 optical
signal, recovered from received STM-1
electrical signal, external MTS - data or
clock format (as ITU-T G.811)

Frequency offset generation: Up to
 ± 999 ppm in 0.1 ppm steps

**STM-4 error add (Not available if
SDH option is US1):** Frame - single
and N in 4 frame words, MS B2 BIP -
 10^{-4} to 10^{-9}

STM-4 alarm generation: Loss of
signal (requires A1T), loss of frame
(requires A1T), multiplexer section
AIS, multiplexer section FERF.

STM-4 thru mode: The STM-4 signal
is passed through the HP 37717C
without being altered for monitoring
purposes where no protected monitor
point is available.

STM-4 Tx Overhead: Standard
overhead values to ITU-T G.70X

**User programmable bytes (Not
available if SDH option is US1):**

RSOH: A1, A2, C1, E1, F1, D1-D3
MSOH: H1 (SS bits only), K1, K2,
D4-D12, S1, Z2 (column 4), Z1 & Z2
(for STM-1 under test), M1 (when
STM-1 number 3 selected for test)

**STM-4 sequence generation (Not
available if SDH option is US1):** A
single or multi-byte overhead channel
is overwritten with a single or repeating
sequence of programmed values. The
sequence can contain up to 5 different
values each being transmitted for up to
64,000 frames.

RSOH: D1-D3, E1, F1, C1 (for STM-1
under test), D4-D12, K1-K2, S1, E2,
Z1 & Z2 (for STM-1 under test), M1
(when STM-1 number 3 selected for
test)

High order POH: J1, C2, G1, F2, H4,
Z3, Z4, Z5 (for STM-1 under test)

**STM-4 overhead BER test (Not
available if SDH option is US1):** Any

General Information

Specifications

overhead channel listed under STM-4 sequence generation (except Z1, Z2) can have a 2^9 -1 PRBS inserted into a 64 kb/s channel. Single errors can be added to the test pattern and a BER measurement performed.

STM-4 MSP message generation:

Messages are displayed in text form as ITU-T G.783.

User programmed sequences (Not available if SDH option is US1).

Receive:

Wavelength: 1200 - 1600 nm

Sensitivity: STM-1 -34dBm minimum, STM-4 -28 dB minimum (with 1300 nm wavelength, 100% modulation depth, BER of 10^{-10} and 2^{23} PRBS)

Maximum input power: -8 dBm (for BER of 10^{-10}). Damage level +10 dBm

Protected monitor point:

Input level: nominal 150 mV to 1000 mV pk-pk

Line code: NRZ

Impedance: Nominal 50Ω , AC coupled

Optical power measurement: Range 0 to -30dBm, Accuracy ± 1 dB

STM-4 error results: RS B1, MS B2

STM-4 alarms detected: Loss of signal, loss of frame, out of frame, multiplexer section AIS, multiplexer section FERF, clock loss, K1/K2 change, (Not available if SDH option is US1).

STM-4 overhead sequence capture:

A single or multibyte overhead channel can be monitored. After a manual or programmed trigger, the captured byte values are displayed together with the number of consecutive frames containing the value.

RSOH: A1A2, E1, F1, C1, (for STM-1 under test), D1-D3

MSOH: H1H2, K1K2, D4-D12, S1, E2, Z1 & Z2 (for STM-1 under test), M1 (when STM-1 number3 selected for test)

High order POH: J1, C2, G1, F2, H4, Z3, Z4, Z5 (for STM-1 under test)

STM-4 overhead BER measurement (Not available if SDH option is US1):

Any RSOH, MSOH or POH channel listed under STM-4 overhead sequence capture can be selected and a BER measurement using the 2^9 -1 PRBS provided by the transmit overhead BER test function. Error count, error ratio, error free seconds, percentage error free seconds and pattern loss seconds are calculated

STM-1/STM-4 (1310/1550 nm) OPTICAL INTERFACE with STM-4 Overhead Option USN

Rate: 155.52 Mb/s, 622.08 Mb/s

Line code: NRZ

Connectors: Adaptors to which a range of interfaces can be attached.

Transmit:

Wavelength: 1280 - 1330 nm or 1520 - 1565 nm

Spectral width: 2.5 nm rms nominal

Extinction ratio: 1310 nm - <8.2dB nominal, 1550 nm - <10dB nominal

Fibre power output: 1310 nm -10dBm nominal 1550 nm -1 dBm nominal

Safety classification: Class 3A, FDA 21 CFR Ch.1 1040.10 and EN 60825

Clock timing: Internal, recovered from received STM-1 or STM-4 optical signal, recovered from received STM-1

General Information

Specifications

electrical signal, external MTS - data or clock format (as ITU-T G.811)

Frequency offset generation: Up to ± 999 ppm in 0.1 ppm steps

STM-4 error add (Not available if SDH option is US1): Frame - single and N in 4 frame words, MS B2 BIP - 10^{-4} to 10^{-9}

STM-4 alarm generation: Loss of signal (requires A1T), loss of frame (requires A1T), multiplexer section AIS, multiplexer section FERF.

STM-4 thru mode: The STM-4 signal is passed through the HP 37717C without being altered for monitoring purposes where no protected monitor point is available.

STM-4 Tx Overhead: Standard overhead values to ITU-T G.70X

User programmable bytes (Not available if SDH option is US1):

RSOH: A1, A2, C1, E1, F1, D1-D3

MSOH: H1 (SS bits only), K1, K2, D4-D12, S1, Z2 (column 4), Z1 & Z2 (for STM-1 under test), M1 (when STM-1 number 3 selected for test)

STM-4 sequence generation (Not available if SDH option is US1): A single or multi-byte overhead channel is overwritten with a single or repeating sequence of programmed values. The sequence can contain up to 5 different values each being transmitted for up to 64,000 frames.

RSOH: D1-D3, E1, F1, C1 (for STM-1 under test), D4-D12, K1-K2, S1, E2, Z1 & Z2 (for STM-1 under test), M1 (when STM-1 number 3 selected for test)

High order POH: J1, C2, G1, F2, H4, Z3, Z4, Z5 (for STM-1 under test)

STM-4 overhead BER test (Not available if SDH option is US1): Any overhead channel listed under STM-4 sequence generation (except Z1, Z2) can have a 2^9-1 PRBS inserted into a 64 kb/s channel. Single errors can be added to the test pattern and a BER measurement performed.

STM-4 MSP message generation: Messages are displayed in text form as ITU-T G.783.

User programmed sequences (Not available if SDH option is US1).

Receive:

Wavelength: 1200 - 1600 nm

Sensitivity: STM-1 -34dBm minimum, STM-4 -28 dB minimum (with 1310 nm wavelength, 100% modulation depth, BER of 10^{-10} and 2^{23} PRBS)

Maximum input power: -8 dBm (for BER of 10^{-10}). Damage level +10 dBm

Protected monitor point:

Input level: nominal 150 mV to 1000 mV pk-pk

Line code: NRZ

Impedance: Nominal 50Ω , AC coupled

Optical power measurement: Range 0 to -30dBm, Accuracy ± 1 dB

STM-4 error results: RS B1 BIP, MS B2 BIP

STM-4 alarms detected: Loss of signal, loss of frame, out of frame, multiplexer section AIS, multiplexer section FERF, clock loss, K1/K2 change, (Not available if SDH option is US1).

STM-4 overhead sequence capture

General Information

Specifications

(Not available if SDH option is US1):

A single or multibyte overhead channel can be monitored. After a manual or programmed trigger, the captured byte values are displayed together with the number of consecutive frames containing the value.

RSOH: A1A2, E1, F1, C1, (for STM-1 under test), D1-D3

MSOH: H1H2, K1K2, D4-D12, S1, E2, Z1 & Z2 (for STM-1 under test), M1 (when STM-1 number3 selected for test)

High order POH: J1, C2, G1, F2, H4, Z3, Z4, Z5 (for STM-1 under test)

STM-4 overhead BER measurement (Not available if SDH option is US1):

Any RSOH, MSOH or POH channel listed under STM-4 overhead sequence capture can be selected and a BER measurement performed using the 2^9-1 PRBS provided by the transmit overhead BER test function.

Error count, error ratio, error free seconds, percentage error free seconds and pattern loss seconds are calculated.

STM-0/STM-1/STM-4 OPTICAL INTERFACE (1310 nm) with STM-4c Overhead Option 131

Rate: 51.84 Mb/s, 155.52 Mb/s

Line code: NRZ

Connectors: Adaptors to which a range of interfaces can be attached.

Transmit:

Wavelength: 1280 - 1330 nm

Spectral width: 2.5 nm rms nominal

Extinction ratio: <8.2dB nominal

Fibre power output: -10dBm nominal

Safety classification: Class 3A, FDA 21 CFR Ch.1 1040.10 and EN 60825

Clock timing: Internal, recovered from received STM-0, STM-1 or STM-4 optical, electrical or binary signal, external MTS - data or clock format (as ITU-T G.811)

Frequency offset generation: Up to ± 999 ppm in 0.1 ppm steps

VC-4-4C error add: B3 BIP, HP REI, HP IEC - 10^{-4} to 10^{-9} , Bit - 10^{-3} to 10^{-9} . VC-4-4C alarm generation: AU-AIS, HP-RDI, AU-LOP, Path Unequipped

STM-4 error add: Frame - single and N in 4 frame words, B1 BIP - 10^{-4} to 10^{-9} , B2 BIP and RS REI - 10^{-3} to 10^{-9} .

STM-4 alarm generation: Loss of signal, loss of frame, out of frame, multiplexer section AIS, multiplexer section RDI.

STM-4 thru mode:

Transparent mode: The STM-4 signal is passed through the HP 37717B without being altered. The BIP's are not recalculated.

Overhead overwrite STM-4 mode:

The test features associated with the section overhead can be enabled in order to control one single or multi byte overhead channel. The B1 and B2 bytes are recalculated.

Overhead overwrite STM-4-4C

mode: The test features associated with the section overhead and path overhead can be enabled in order to control one single or multi byte overhead channel. The B1, B2 and B3 bytes are recalculated.

AU-4 overwrite mode: Overwrite the complete AU-4 with the internally generated payload. This enables the

General Information

Specifications

SOH and the three background AU-4's to be looped through while a new payload is inserted into the STM-1 under test. All of the test features which affect the VC-4 and/or the POH are enabled. The B1, B2 and B3 bytes are recalculated. The AU-4 under test is delayed by a greater amount than the three background AU-4's.

Tributary overwrite: If the payload contains a TU structure a single TU can be overwritten. All of the test features which affect the tributary and/or the POH are enabled. The B1, B2, B3 and TU BIP bytes are recalculated.

STM-4 Tx Overhead: Standard overhead values to ITU-T G.707

User programmable bytes:

RSOH: A1, A2, J0, Z0, E1, F1, D1-D3

MSOH: H1 (SS bits only), K1, K2, D4-D12, S1, Z1 & Z2, M1.

STM-4 sequence generation: A single or multi-byte overhead channel is overwritten with a single or repeating sequence of programmed values. The sequence can contain up to 5 different values each being transmitted for up to 64,000 frames.

RSOH: D1-D3, J0, E1, F1, Z0.

MSOH: D4-D12, K1-K2, S1, E2, M1, Z1, Z2.

High order POH: J1, C2, G1, F2, H4, F3, K3, N1 (for STM-1 under test)

STM-4 overhead BER test: Any overhead channel listed under STM-4 sequence generation (except Z1, Z2) can have a 2^9-1 PRBS inserted into a 64 kb/s channel. Single errors can be added to the test pattern and a BER measurement performed.

STM-4 MSP message generation:

Messages are displayed in text form as ITU-T G.783 (Linear) or ITU-T G.841 (Ring).

Receive:

Wavelength: 1200 - 1600 nm

Sensitivity: STM-0 and STM-1 - 34dBm minimum, STM-4 -28 dB minimum (with 1300 nm wavelength, 100% modulation depth, BER of 10^{-10} and 2^{23} PRBS)

Maximum input power: -8 dBm (for BER of 10^{-10}). Damage level +10 dBm

Protected monitor point:

Input level: nominal 150 mV to 1000 mV pk-pk

Line code: NRZ

Impedance: Nominal 50Ω , AC coupled

Optical power measurement: Range 0 to -30dBm, Accuracy ± 1 dB

STM-4 error results: Frame (A1A2), B1 BIP, B2 BIP, MS REI

VC-4--4c error results: B3 BIP, HP REI, HP IEC, Bit

STM-4 alarms detected: Loss of signal, loss of frame, out of frame, MS AIS, MS RDI, K1/K2 change.

STM-4c alarms detected: All STM-4 alarms and Loss of pointer, AU AIS, HP RDI, pattern sync loss

STM-4 overhead sequence capture:

A single or multibyte overhead channel can be monitored. After a manual or programmed trigger, the captured byte values are displayed together with the number of consecutive frames containing the value.

RSOH: A1A2 for all four STM-1's, J0 E1, F1, D1-D3, Z0.

MSOH: H1H2, K1K2, D4-D12, S1, E2, Z1, Z2

General Information

Specifications

High order POH: J1, C2, G1, F2, H4, F3, K3, N1 for STM-1 under test)

Overhead BER measurement (STM-4): J0, Z0, E1, F1, D1, D2, D3, D4, D5, D6, D7, D8, D9, D10, D11, D12, K1, K2, S1, M1, E2, J1, C2, G1, F2, H4, F3, K3 & N1. A BER measurement can be performed on any of these bytes using the 2^9-1 PRBS provided by the transmit overhead BER test function. Error count, error ratio, error free seconds, percentage error free seconds and pattern loss seconds are calculated

STM-0/STM-1/STM-4 OPTICAL INTERFACE (1310/1550 nm) with STM-4c Overhead Option 130

Rate: 51.84 Mb/s, 155.52 Mb/s, 622.08 Mb/s

Line code: NRZ

Connectors: Adaptors to which a range of interfaces can be attached.

Transmit:

Wavelength: 1280 - 1330 nm and 1520 - 1565 nm.

Spectral width (3dB): 2.5 nm rms nominal (1310 nm)

Spectral width (20dB): 1 nm rms nominal (1550 nm)

Extinction ratio: <8.2dB nominal (1310 nm), <10 dBm nominal (1550 nm).

Fibre power output: -10dBm nominal (1310 nm), -1 dBm nominal (1550 nm).

Safety classification: Class 3A, FDA 21 CFR Ch.1 1040.10 and EN 60825

Clock timing: Internal, recovered from received STM-0, STM-1 or STM-4 optical, electrical or binary signal,

external MTS - data or clock format (as ITU-T G.811)

Frequency offset generation: Up to ± 999 ppm in 0.1 ppm steps

VC-4-4C error add: B3 BIP, HP REI, HP IEC - 10^{-4} to 10^{-9} , Bit - 10^{-3} to 10^{-9} .
VC-4-4C alarm generation: AU-AIS, HP-RDI, AU-LOP, Path Unequipped

STM-4 error add: Frame - single and N in 4 frame words, B1 BIP - 10^{-4} to 10^{-9} , B2 BIP and RS REI - 10^{-3} to 10^{-9} ,
STM-4 alarm generation: Loss of signal, loss of frame, out of frame, multiplexer section AIS, multiplexer section RDI.

STM-4 thru mode:

Transparent mode: The STM-4 signal is passed through the HP 37717B without being altered. The BIP's are not recalculated.

Overhead overwrite STM-4 mode:

The test features associated with the section overhead can be enabled in order to control one single or multi byte overhead channel. The B1 and B2 bytes are recalculated.

Overhead overwrite STM-4-4C

mode: The test features associated with the section overhead and path overhead can be enabled in order to control one single or multi byte overhead channel. The B1, B2 and B3 bytes are recalculated.

AU-4 overwrite mode: Overwrite the complete AU-4 with the internally generated payload. This enables the SOH and the three background AU-4's to be looped through while a new payload is inserted into the STM-1 under test. All of the test features which affect the VC-4 and/or the POH are

General Information

Specifications

enabled. The B1, B2 and B3 bytes are recalculated. The AU-4 under test is delayed by a greater amount than the three background AU-4's.

Tributary overwrite: If the payload contains a TU structure a single TU can be overwritten. All of the test features which affect the tributary and/or the POH are enabled. The B1, B2, B3 and TU BIP bytes are recalculated.

STM-4 Tx Overhead: Standard overhead values to ITU-T G.707

User programmable bytes:

RSOH: A1, A2, J0, Z0, E1, F1, D1-D3

MSOH: H1 (SS bits only), K1, K2, D4-D12, S1, Z1 & Z2, M1.

STM-4 sequence generation: A single or multi-byte overhead channel is overwritten with a single or repeating sequence of programmed values. The sequence can contain up to 5 different values each being transmitted for up to 64,000 frames.

RSOH: D1-D3, J0, E1, F1, Z0.

MSOH: D4-D12, K1-K2, S1, E2, M1, Z1, Z2.

High order POH: J1, C2, G1, F2, H4, F3, K3, N1 (for STM-1 under test)

STM-4 overhead BER test: Any overhead channel listed under STM-4 sequence generation (except Z1, Z2) can have a 2^9-1 PRBS inserted into a 64 kb/s channel. Single errors can be added to the test pattern and a BER measurement performed.

STM-4 MSP message generation:

Messages are displayed in text form as ITU-T G.783 (Linear) or ITU-T G.841 (Ring).

Receive:

Wavelength: 1200 - 1600 nm

Sensitivity: STM-0 and STM-1 - 34dBm minimum, STM-4 -28 dB minimum (with 1300 nm wavelength, 100% modulation depth, BER of 10^{-10} and 2^{23} PRBS)

Maximum input power: -8 dBm (for BER of 10^{-10}). Damage level +10 dBm

Protected monitor point:

Input level: nominal 150 mV to 1000 mV pk-pk

Line code: NRZ

Impedance: Nominal 50Ω , AC coupled

Optical power measurement: Range 0 to -30dBm, Accuracy ± 1 dB

STM-4 error results: Frame (A1A2), B1 BIP, B2 BIP, MS REI

VC-4--4c error results: B3 BIP, HP REI, HP IEC, Bit

STM-4 alarms detected: Loss of signal, loss of frame, out of frame, MS AIS, MS RDI, K1/K2 change.

STM-4c alarms detected: All STM-4 alarms and Loss of pointer, AU AIS, HP RDI, pattern sync loss

STM-4 overhead sequence capture:

A single or multibyte overhead channel can be monitored. After a manual or programmed trigger, the captured byte values are displayed together with the number of consecutive frames containing the value.

RSOH: A1A2 for all four STM-1's, J0 E1, F1, D1-D3, Z0.

MSOH: H1H2, K1K2, D4-D12, S1, E2, Z1, Z2

High order POH: J1, C2, G1, F2, H4, F3, K3, N1 for STM-1 under test)

Overhead BER measurement (STM-4): J0, Z0, E1, F1, D1, D2, D3, D4, D5,

General Information

Specifications

D6, D7, D8, D9, D10, D11, D12, K1, K2, S1, M1, E2, J1, C2, G1, F2, H4, F3, K3 & N1. A BER measurement can be performed on any of these bytes using the 2^9-1 PRBS provided by the transmit overhead BER test function. Error count, error ratio, error free seconds, percentage error free seconds and pattern loss seconds are calculated

SDH Binary Interface (Option 0YH)

Rate: 155.52 MHz

Clock & Data Polarity: Positive or inverted

Connectors: SMA

Data format: NRZ

Data level: ECL

Data termination: 50Ω to -2V

Transmit:

Clock duty cycle: 50% (nominal)

Clock to data timing: Clock edge nominally 800 ps before centre of data output.

Receive:

Clock duty cycle: 50% $\pm 10\%$

Input return loss: >15dB up to half rate
Data setup and hold time: 600 ps minimum

JITTER GENERATION:

Option UHK Adds Jitter generation at all standard PDH rates with the exception of 704 kb/s. If Option US1 or A1T is fitted adds Jitter generation at STM-1 and STM-4.

Data rates: 2.048 Mb/s, 8.448 Mb/s, 34.368 Mb/s, 139.264 Mb/s, 155.52 Mb/s (STM-1), 622.08 Mb/s (STM-4).
At STM-1 and STM-4 a jittered

139.264 Mb/s clock is used to jitter the SDH clock. The UI transfer function is 1:1 at STM-1 and 1:4 at STM-4.

Jitter modulation

Frequency: 2 Hz to 4 MHz

Frequency accuracy: $\pm 1\%$

Frequency resolution:

2 to 499 Hz in 1 Hz steps.

500 Hz to 4.99 kHz in 10 Hz steps

5 kHz to 49.9 kHz in 100 Hz steps

50 kHz to 499 kHz in 1 kHz steps

500 kHz to 990 kHz in 10 kHz steps

1 MHz to 4 MHz in 100 kHz steps.

The actual corner frequencies of the jitter generator will be beyond those in the ITU-T mask.

2.048 Mb/s: Corner frequency 13 kHz, Cut-off frequency 102 kHz

8.448 Mb/s: Corner frequency 50 kHz, Cut-off frequency 422 kHz

34.368 Mb/s: Corner frequency 210 kHz, Cut-off frequency 840 kHz

139.264 Mb/s: Corner frequency 5 kHz, Cut-off frequency 4 MHz

Amplitude: To ITU-T O.171

Amplitude ranges: 0.00 to 1.00 UI - Range 1 0.0 to 10.0 UI - Range 10

Range accuracy: Range 1 - 0.01 UI
Range 10 - 0.1 UI

Intrinsic jitter:

2.048 Mb/s - 0.02 UI

8.448 Mb/s - 0.02 UI

34.368 Mb/s - 0.03 UI

139.264 Mb/s - >10 kHz - 0.02 UI 5

kHz to 10 kHz - 0.05 UI 200 Hz to 5

kHz - 0.10 UI

Values are pk-pk jitter measured with HP1 filter present.

Amplitude accuracy: $\pm 5\%$ \pm range accuracy \pm intrinsic jitter.

Fixed jitter tolerance masks: 4 pre-programmed jitter tolerance masks with

General Information

Specifications

pk-pk jitter amplitudes and modulating frequencies in accordance with ITU-T Rec. G.823 Table 2, covering low and high Q systems.

The masks can be used to measure tolerance to jitter amplitude at spot jitter frequencies or can be swept in 20% frequency increments.

When generating an SDH signal the masks available are those specified in ITU-T Rec. G.958. A choice of type A or B masks is available at STM-1 and STM-4.

Automatic jitter tolerance test: The mask is swept in 20% frequency increments and at each frequency the jitter amplitude is increased until errors (of any type) are detected.

JITTER and WANDER GENERATION (Options A3K [A3Q]) and EXTENDED JITTER GENERATION (Options 140 [141]):

A3K [A3Q] Adds Jitter generation at all standard PDH rates with the exception of 704 kb/s. Adds Wander generation at 2.048 Mb/s. If Option US1 or A1T (SDH) is fitted adds Jitter and Wander generation at STM-1 and STM-4.

140 [141] Adds Jitter generation at all standard PDH rates with the exception of 704 kb/s. If Option US1, A3R or A1T (SDH) is fitted adds Jitter generation at STM-1 and STM-4.

Jitter Generation:

Data rates: 2.048 Mb/s, 8.448 Mb/s, 34.368 Mb/s, 139.264 Mb/s, 155.52 Mb/s (STM-1), 622.08 Mb/s (STM-4).

At STM-1 and STM-4 a jittered 139.264 Mb/s clock is used to jitter the SDH clock. The UI transfer function is 1:1 at STM-1 and 1:4 at STM-4.

Jitter modulation

Frequency: 0.1 Hz to 5 MHz

Frequency accuracy: $\pm 1\%$ $> 3\text{Hz}$, $\pm 3\%$ $< 3\text{Hz}$

Frequency resolution: 1Hz (Ranges 1 & 10), 0.1Hz (ranges 50, 80 & 200)

The actual corner frequencies of the jitter generator will be beyond those in the ITU-T mask.

2.048 Mb/s: Corner frequency 13 kHz, Cut-off frequency 102 kHz

8.448 Mb/s: Corner frequency 50 kHz, Cut-off frequency 430 kHz

34.368 Mb/s: Corner frequency 100 kHz, Cut-off frequency 840 kHz

139.264 Mb/s: Corner frequency 5 kHz, Cut-off frequency 4 MHz

155.52 Mb/s: Corner frequency 5 kHz, Cut-off frequency 4 MHz

622.08 Mb/s: Corner frequency 5 kHz, Cut-off frequency 4 MHz

Amplitude: To ITU-T O.171

Amplitude ranges: 0.00 to 1.00 UI - Range 1

0.0 to 10.0 UI - Range 10

0.0 to 50.0 UI - Range 50

0.0 to 80.0 UI - Range 80

0.0 to 200.0 UI - Range 200

General Information

Specifications

Range accuracy: Range 1 - 0.01 UI

Range 10 - 0.1 UI

Range 50 - 0.5 UI

Range 80 - 1.0 UI

Range 200 - 2.0 UI

Intrinsic jitter:

2.048 Mb/s - 0.02 UI

8.448 Mb/s - 0.02 UI

34.368 Mb/s - 0.03 UI

139.264 Mb/s - >10 kHz - 0.02 UI <10 kHz - 0.04 UI

STM-1 - >10kHz - 0.03 UI <10 kHz - 0.04

STM-4 - 0.10 UI Values are pk-pk jitter measured with HP1 filter present.

High frequency inaccuracy: STM-1

Electrical >1.3 MHz

<0.2 UI $\pm 10\%$

>0.2 UI $\pm 20\%$

Amplitude accuracy:

PDH rates: $\pm 5\%$ \pm range accuracy \pm intrinsic jitter.

SDH rates: $\pm 5\%$ \pm range accuracy \pm intrinsic jitter \pm high frequency inaccuracy

Fixed jitter tolerance masks: 6 pre-programmed jitter tolerance masks with pk-pk jitter amplitudes and modulating frequencies in accordance with ITU-T Rec. G.823 Table 2, covering low and high Q systems. The masks can be used to measure tolerance to jitter amplitude at spot jitter frequencies or can be swept in 20% frequency increments. When generating an SDH signal the masks available are those specified in ITU-T Rec. G.958. A choice of type A or B masks is available at STM-1 and STM-4.

Automatic jitter tolerance test: The mask is swept in 20% frequency

increments and at each frequency the jitter amplitude is increased until errors (of any type) are detected.

External jitter modulation input:

Frequency range: 2 Hz to 5 MHz.

Voltage response at 10 kHz:

10 UI range: $0.7V \pm 0.2V$ pk-pk/UI.

2 UI range: $3V \pm 1V$ pk-pk/UI.

Maximum input level: 6V peak AC/DC composite.

Wander generation Options A3K

[A3Q] only:

Data rates: 2.048 Mb/s, 155.52 Mb/s, 622.08 Mb/s.

Wander modulation:

Frequency: 0.000010 Hz to 0.125000 Hz

Frequency accuracy: $\pm 1\%$.

Frequency resolution: 1 μ Hz.

Amplitude range:

2 Mb/s: 0.5 to 80UI in 0.5UI steps.

STM-1: 0.5 3600UI in 0.5UI steps.

STM-4: 0.5 to 14400UI in 0.5UI steps.

Intrinsic jitter: 0.1 UI

Rate inaccuracy:

2.048 Mb/s 1.0 UI

155.52 Mb/s 0.5 UI

622.08 Mb/s 0.5 UI

Amplitude accuracy: $\pm 5\%$ \pm intrinsic jitter \pm rate inaccuracy.

Pre-programmed wander tolerance masks with pk-pk wander amplitudes. When 2.048 Mb/s is selected mask is in accordance with ITU-T Rec. G.823. When 155.52 Mb/s or 622.08 Mb/s is selected mask is in accordance with ITU-T Rec. G.958.

Wander reference input:

Rate: 2.048 Mb/s ± 100 ppm.

Format: Clock or HDB3 Data.

Impedance: Nominal; 75 Ω

General Information

Specifications

unbalanced or 120 Ω balanced.

Peak Level: 3V \pm 10% (balanced),
2.37V \pm 10% (unbalanced).

JITTER RECEIVER (Options UHN, A1M, A1N, A1P, A3L, A3V and A3N):

Option UHN adds PDH jitter measurement at all standard PDH rates with the exception of 704 kb/s. Adds Wander and Estimated slips measurements at 2.048 Mb/s.

Option A1M adds SDH Jitter measurement at 155.52 Mb/s (STM-1 electrical).

Option A1N adds SDH Jitter measurement at 155.52 Mb/s (STM-1 optical).

Option A1P adds SDH Jitter measurement at 155.52/622.08 Mb/s (STM-1/STM-4 optical).

Option A3L [A3M] Adds Pk-Pk jitter, RMS jitter and Auto Jitter Transfer measurement at STM-1 (electrical) rate and at all PDH rates except 704 kb/s. Adds Wander and Estimated Slips measurement at 2.048 Mb/s

Option A3V [A3W] Adds Pk-Pk jitter, RMS jitter and Auto Jitter Transfer measurement at STM-1 (optical) rate, STM-1 (electrical) rate, and at all PDH rates except 704 kb/s Pk-Pk. Adds Wander and Estimated Slips measurement at 2.048 Mb/s

Option A3N [A3P] Adds Pk-Pk jitter, RMS jitter and Auto Jitter Transfer measurement at STM-4 (optical) rate, STM-1 (optical) rate, STM-1 (electrical) rate, and at all PDH rates except 704 kb/s Pk-Pk. Adds Wander and Estimated Slips measurement at 2.048 Mb/s.

Options A1M, A1N, A1P, A3L, A3V

and A3N add PDH jitter measurement.

Jitter Data rates: 2.048 Mb/s, 8.448 Mb/s, 34.368 Mb/s, 139.264 Mb/s, 155.52 Mb/s STM-1, 622.08 Mb/s STM-4.

STM-1 Electrical Input

Line Code: CMI

Impedance: 75 Ω nominal, unbalanced

Level: Nominal 1 Volt peak to peak into 75 Ω

Equalization: Automatic for cable loss up to 12 dB at half the bit rate.

Monitor: Equalization as above but with an extra 20 - 26dB of flat gain.

The receiver will compensate automatically for any combination of flat loss in the 20 -26dB range and cable loss up to 12dB.

Connector: BNC

STM-1 Optical Receiver

Line Code: NRZ

Wavelength: 1200 to 1600nm.

Sensitivity: -28 dBm minimum. This specification applies with 1300nm wavelength, 100% modulation depth, BER of 1.0E-10 and 2²³-1 PRBS data.

Dynamic Range: 20 dB minimum.

Maximum Input Power: -8 dBm.

(For BER of 1.0E-10)

Connector: Customer Exchangeable System.

STM-1/STM-4 Optical Receiver

Data Rate (nominal): 155.52 Mb/s. or 622.08 Mb/s.

Line Code: NRZ

Wavelength: 1200 to 1600nm.

Sensitivity: -26 dBm minimum

This specification applies with 1300nm wavelength, 100% modulation depth, BER of 1.0E-10 and 2²³-1 PRBS

General Information

Specifications

data.

Dynamic Range: 18dB minimum.

Maximum Input Power: -8 dBm. (For BER of 1.0E-10). If > +3.0 dBm then damage may result.

Connector: Customer Exchangeable system.

Alarms Detected: Loss of Signal:
Loss of signal is detected in the optical receiver whenever the light level falls below approximately -30dBm ±3dBm. To extinguish the alarm requires a light level approximately 1 - 2 dB higher than this threshold.

General Jitter Receiver Specifications

Jitter measurement ranges:

Range 1.6 - 0 to 1.6 UI

Range 16 - 0 to 16 UI

These ranges fulfil the measurement requirements of ITU-T Rec. O.171 Table 3

Range accuracy:

Range 1.6 - ±0.01 UI

Range 16 - ±0.03 UI

Intrinsic jitter:

Range 1.6 (2, 8, 34, 140 Mb/s):

Clock - ±0.02 UI

Range 1.6 ((2, 8, 34, 140, 155.52 Mb/s electrical): PRBS - ±0.02 UI

Range 1.6 (155.52 Mb/s optical):

PRBS - ±0.03 UI

Range 1.6 (622.08 Mb/s optical):

PRBS - ±0.04 UI

Range 16 (2, 8, 34, 140 Mb/s):

Clock - ±0.07 UI

Range 16 (2, 8, 34, 140, 155.52 Mb/s):

PRBS - ±0.1 UI

Range 16 (622.08 Mb/s):

PRBS - ±0.2 UI

Values are pk-pk jitter measured with HP1 filter present.

Jitter Transfer Receiver Characteristics

The value plotted is the Transfer Function, calculated using equation

$$20\log\frac{J_{out}}{J_{in}}\text{dB}$$

Measurement Bandwidth: 10Hz

Dynamic Range: +5dB to -40dB

Stability: 0.02dB

The Measurement cycle must be started within 10 minutes of the completion of the Calibration cycle.

Calibration: 0.01dB

Accuracy: The figures quoted in the following table includes *Stability & Calibration* factors,

Jitter Transfer Function Accuracy	
Rx Jitter Amplitude UI	Accuracy dB
3 to 0.3	0.04
0.3 to 0.03	0.25
0.03 to 0.01	0.5
0.01 to 0.003	1
0.003 to 0.001	3

Examples:

Input 1.5UI, +0.5dB Transfer Function, output is 1.589UI. The accuracy will be 0.04dB.

Input 0.2UI, -19.5dB Transfer Function, then output is 0.0219UI. The accuracy will be 0.5dB.

Ideally there should be no coherent spurious signals generated by the UUT as any such signals close to measurement frequencies will degrade the instrument performance.

The input Line Rate should be within ±50 ppm of nominal to achieve Accuracy quoted.

General Information

Specifications

The HP 37717C must be connected back to back in order to perform a calibration cycle before making a Jitter Transfer measurement.

The HP 37717C must have been switched on for 1 hour before starting a calibration cycle.

The climatic conditions must remain stable from switch-on to end of measurement.

It is recommended that the maximum test period (start of calibration to end of measurement) does not exceed 90 minutes.

Test Period = Delay Time + Dwell Time + 5 Seconds X Number of Points X 2 (Calibration + Measurement).

Peak Jitter Measurement

These ranges cover the measurements range specified in O.171, Table3/O.171.

Receiver Ranges		
Range	Lower UI pp	Upper UI pp
1.6	0	1.6
16	0	16

Note that the receiver will be able to handle transients of up to 24UI(peak) without losing lock, although the measurement will be out of range.

On Losing Lock the *Jitter Loss* LED is illuminated. If Lock is maintained but the measurement is out of range then a Status Message “Jitter Out of Range” is displayed on the Status Line.

Peak Measurement Bandwidth			
Bit Rate (Kb/s)	Bandwidth		
	Min. *	Max	
		Range 1.6UI**	Range 16UI
2048	2Hz	100 kHz	50 kHz
8448	2Hz	400 kHz	100 kHz
34368	2Hz	800 kHz	400 kHz
139264	2Hz	3.5 MHz	800 kHz
155520	2Hz	1.3 MHz	800 kHz
622080	2Hz	5.0 MHz	800 kHz

* 7Hz For Rev.A of Options UHK, A1M, A1N, A1P

** Meets ITU O.171 Table 4.

General Information

Specifications

Peak Measurement Accuracy

For 2Mb/s & 8Mb/s, the specification applies when HDB3 encoding is enabled.

Range	Level	Accuracy	
		peak	pk-pk
1.6UI	0 - 0.2 UI	$\pm 5\% \pm X \pm Y \pm Z$	$\pm 5\% \pm 2X \pm Y \pm 2Z$
1.6UI	0.21 - 1.6 UI	$\pm 5\% \pm X \pm Y \pm Z$	$\pm 5\% \pm 2X \pm Y \pm 2Z$
16UI	0 - 0.2 UI	$\pm 5\% \pm X \pm Y \pm Z^*$	$\pm 5\% \pm 2X \pm Y \pm 2Z^*$
16UI	0.21 - 16.0 UI	$\pm 5\% \pm X \pm Y \pm Z^*$	$\pm 5\% \pm 2X \pm Y \pm 2Z^*$

* Only has an effect for 2Mb/s operation.

X = 0.01 UI for range 1.6
0.03 UI for range 16,

Z = the amount of inaccuracy introduced at high frequency.

Y is intrinsic jitter.

Receiver Intrinsic Jitter			
Bit Rate (Kb/s)	Range 1.6 Intrinsic Jitter (UI)	Range 16 Intrinsic Jitter (UI)	
		Clock (all 1's)	PRBS
	Y	Y	Y
2048	0.02	0.07	0.10*
8448	0.02	0.07	0.10*
34368	0.02	0.07	0.10*
139264	0.02	0.07	0.10*
155520 (electrical)	0.02	n/a	0.10
155520 (optical)	0.03	n/a	0.10
622080 (optical)	0.04	n/a	0.20

* Typical value after calibration is 0.05UI.

General Information

Specifications

High Frequency Inaccuracy		
Bit Rate (Kb/s)	Selected Frequency	Z (UI)
SDH Rates	All	0
2048	>30KHz	$\frac{(f - 30)}{70} \times 10 \% ^*$
8448	>150KHz	$\frac{(f - 150)}{250} \times 10 \% ^*$
34368, 139264	all	0

* Where f is the Modulation Frequency in KHz.

Note 1: Typically there will be an additional 0.01 UI when using monitor gain.

Note 2: Typically there will be an additional 0.01 UI when using equalisation.

Note 3: Typically there will be an additional 0.01 UI at STM-1 optical with light levels less than -22 dBm.

Note 4: Typically there will be an additional 0.01 UI at STM-4 with light levels less than -16 dBm.

Note 5: Typically there will be an additional 0.02 UI at STM-4 with light levels less than -22 dBm.

Note 6: Typically there will be an additional 0.01 UI due to temperature variation.

Note 7: When performing intrinsic measurements with the transmitter coupled to the receiver, the transmitter intrinsics must be included.

Values are peak to peak jitter in UI measured with HP1 filter present,

Jitter Peak Results Resolution:

Range 1.6 steps of 0.001 UI.

Range 16 steps of 0.01 UI.

Jitter Hit Count: The number of times in the jitter gating period that the received jitter amplitude exceeds a user set threshold. Counter capacity is 7,100,000 hits per second.

Jitter Hit Threshold Resolution:

Range 1.6 steps of 0.01 UI.

Range 16 steps of 0.1 UI.

Sensitivity >100 ns width to count typically.

Range 1.6 minimum threshold = 0.05UI.

Range 16 minimum threshold = 0.5UI.

Jitter Hit Seconds:

The number of seconds in which at least one jitter hit has occurred.

Jitter Hit Free Seconds:

The number of seconds in which no jitter hits have occurred.

General Information

Specifications

Internal Filters:

A number of internal filters are available to band limit the demodulated

jitter signal before jitter amplitude measurement. These filters are as specified in ITU O.171.

Nominal 3 dB Corner Frequencies			
Filter (kb/s)	HP1* (high pass) (Hz)	HP2* (high pass) (kHz)	LP** (low pass) (kHz)
2048	20	18	100
8448	20	80	400
34368	100	10	800
139264	200	10	3500
155520	500	65***	1300
622080	1000	250***	5000

* Filter tested to be within 10% of nominal.

** Minimum frequency for the 3dB points.

*** Options A3L, A3V and A3N only.

For high pass filters the slope below the 3 dB point is 20 dB per decade. For the low pass filters the slope above the 3 dB point is 60 dB per decade.

The filters can be selected as follows

- OFF
- LP
- HP1
- HP2
- LP HP1
- LP + HP2
- 12 kHz

The 12 kHz filter is not characterised for pk-pk measurements, hence operation is not specified. (This filter is not recommended in any relevant ITU-T pk-pk measurement standard).

RMS Jitter Measurement (Options A3L, A3V and A3N only):

This measurement is available at all interface rates.

Filters: 12 kHz HP filter selectable. If HP1, HP2 and/or LP are enabled, then they will affect the jitter signal measured by the RMS receiver.

RMS Results Resolution: The RMS ranges are linked to the selection for Peak. No separate selection will exist.

Peak Range 1.6 UI: - RMS range 0.5, steps of 0.002 UI.

Peak Range 16 UI: - RMS Range 5, steps of 0.02 UI.

General Information

Specifications

RMS Measurement Accuracy:

Range	Level (UIrms)	Accuracy	
		20Hz to 3MHz	Additional factor >3MHz
0.5UI	0 - 0.1	$\pm 5\% \pm V \pm W \pm Z$	5%
0.5UI	0.11 - 0.5	$\pm 5\% \pm V \pm W \pm Z$	5%
5UI	0 - 0.1	$\pm 5\% \pm V \pm W \pm Z^*$	5%
5UI	0.11 - 5.0	$\pm 5\% \pm V \pm W \pm Z^*$	5%

* Only has an effect for 2Mb/s operation.

V = (display resolution)
 0.002 UI for range 0.5
 0.02 UI for range 5

W = the intrinsic jitter.
 Z = the amount of inaccuracy introduced at high frequency.

Bit Rate (kb/s)	Range 0.5 Intrinsic Jitter (UIrms)	Range 5 Intrinsic Jitter (UIrms)	
		Clock (all 1's)	PRBS
	W	W	W
2048	0.004	0.03	0.04
8448	0.003	0.03	0.04
34368	0.02	0.04	0.05
139264	0.01	0.03	0.04
155520 (electrical)	0.006	n/a	0.04
155520 (optical)	0.015	n/a	0.04
622080 (optical)	0.02	n/a	0.08

General Information

Specifications

Bit Rate (Kb/s)	Selected Frequency	Z (UI)
SDH Rates	All	0
2048	>30KHz	$\frac{(f - 30)}{70} \times 6 \% ^*$
8448	>150KHz	$\frac{(f - 150)}{250} \times 6 \% ^*$
34368, 139264	All	0

* Where f is the Modulation Frequency in KHz.

Note 1: Typically there will be an additional 0.004 UI rms when using monitor gain.

Note 2: Typically there will be an additional 0.004 UI rms when using equalisation.

Note 3: Typically there will be an additional 0.004 UI rms at STM-1 optical with light levels less than -22 dBm.

Note 4: Typically there will be an additional 0.004 UI rms at STM-4 with light levels less than -16 dBm.

Note 5: Typically there will be an additional 0.008 UI rms at STM-4 with light levels less than -22 dBm.

Note 6: Typically there will be an additional 0.01 UI due to temperature variation.

Values are RMS jitter in UI rms measured with 12 kHz filter present.

RMS Results Resolution:

0.5UI Range:

Display format is 0.001UI rms

5UI Range:

Display format is 0.01UIrms

Demodulated jitter output:

Range 1.6 - 1.0 V/UI

Range 16 - 0.1 V/UI

Accuracy 10% nominal.

Wander:

Timing reference input: External

MTS clock as ITU-T Rec. G.811.

Bit rate: 2.048 Mb/s

Format: Clock or HDB3 data

Impedance: 75Ω unbalanced

(nominal) or 120Ω balanced (nominal).

Peak level: 3V ±10% (balanced) 2.37V

±10% (unbalanced).

Connectors: BNC (unbalanced). 3 pin

Siemens audio (balanced).

Wander measurement:

Bandwidth: Low pass response -3dB

at 10Hz (nominal).

Resolution: 0.125 UI

General Information

Specifications

Range: ± 99999 UI. If no reference signal is present “NO REF” is displayed.

Accuracy: ± 0.125 UI $\pm 0.5\%$ of reading. Valid up to 1 Hz wander frequency.

ATM (Option UKN)

Option UKN provides ATM generation and measurement at standard bit rates.

ATM Transmitter:

Physical Interface Bit rates: 2.048 Mb/s, 34.368 Mb/s, 139.264 Mb/s, 155.52 Mb/s and 622.08 Mb/s (not STM-4c).

Physical Interface: Meets ITU-T G.703

Frequency offset (2.048 Mb/s, 34.368 Mb/s, 139.264 Mb/s): Up to ± 100 ppm

Frequency offset (155.52 Mb/s, 622.08 Mb/s): Up to ± 999 ppm

Connectors: BNC 75Ω unbalanced

Error add: Bit, Single HEC or Double HEC - 1 in 10^3 or single error. Single or Double HEC in Bursts of up to 8 errors.

Alarm generation: Virtual path FERF, virtual path AIS, virtual path continuity check, virtual channel FERF, virtual channel AIS, virtual channel continuity check

Clock timing Internal: All rates

Recovered (loop timed): 2.048 Mb/s only.

External MTS: 155.52 Mb/s, 622.08 Mb/s only.

34.368 Mb/s Overhead: As ITU-T Rec. G.832

Error Monitoring (EM) - correct BIP-8 Trail Trace (TR) - Test: “HP37717C” padded with spaces and the correct CRC added.

User - User defined.

Maintenance Adaptation (MA) - 011 hexadecimal.

Network Operator (NR) - All Zeroes
General Communications (GC) - All Zeroes.

155.52 Mb/s Overhead: As SDH module Option US1, A3R or A1T.

Frame Formats:

2 Mb/s: As ITU-T Rec. G.804 with or without CRC4.

34.368 Mb/s, 139.264 Mb/s: As ITU-T Rec. G.804

155.52 Mb/s: As SDH module Option US1, A3R or A1T

Cell layer modes: UNI, NNI

Cell layer headers: VPI, VCI, GFC, PTI, CLP.

Foreground cells:

2.048 Mb/s bandwidth: 100 to 4528 cells/second.

34.368 Mb/s bandwidth: 100 to 80,000 cells/second.

139.264.368 Mb/s bandwidth: 100 to 326,037 cells/second.

155.52 Mb/s bandwidth: 100 to 353,207 cells/second.

Distribution: Periodic, Burst.

Periodic: A single cell is transmitted at regular intervals determined by the cell rate. Also allows a single burst of up to 2048 consecutive cells to be added.

Burst: User specified burst of up to 2048 consecutive cells added at intervals determined by the cell rate.

General Information

Specifications

Payload: Cross Cell PRBS, Single Cell PRBS, User Byte, Test Cell.

Background cells:

Number of backgrounds: 3

Background density: Individually settable from 0 to maximum after foreground allocation in 1% steps.

Distribution: Periodic as for Constant Bit Rate service.

Payload: Fixed byte.

Fill cells: Idle or Unassigned. Payload GA (Hexadecimal)

ATM Receiver

Interface bit rate: 2.048 Mb/s, 34.368 Mb/s, 139.264 Mb/s \pm 100 ppm unbalanced.

155.52 Mb/s, 622.08 Mb/s \pm 999 ppm unbalanced.

Pattern Synchronization:

Sync loss: BER \geq 20% over 100 ms for PRBS or \geq 4% over 100 ms for word patterns.

Sync gain: 32 consecutive error free bits received.

Equalization at f/2: 12 dB

Monitor point compensation:

2.048 Mb/s: 20 dB, 26 dB or 30 dB.

34.368 Mb/s, 139.264 Mb/s: 20 dB or 26 dB.

Frame Formats: As transmitter.

Frame Alignment: Out of Frame after 4 consecutive errored framing patterns. Frame regain after 2 consecutive error free framing patterns.

Loss Of Frame -At detection of Out Of Frame a 3 ms window is started. If the system remains Out of Frame for the duration of the window then Loss Off Frame is activated. If in frame is detected during the 3 mS window the timer is reset.

Cell layer modes: UNI, NNI

Cell layer headers: VPI, VCI, GFC, PTI, CLP.

Payload: Cross Cell PRBS, Single Cell PRBS, User Byte, Test Cell, Live Traffic.

Test cell synchronization:

Sync loss: 7 consecutive errored cells.

Sync gain: 6 consecutive error free cells.

REMOTE CONTROL:

HP-IB + RS-232-C option A3D.

HP-IB + RS-232-C + LAN interface option A3B.

Virtual Remote option UHE Distributed network Analyzer option USS

PDH MULTIPLE OUTPUTS

(Option UHC): Provides three additional output signals (BNC connectors). Specifications same as for unbalanced signal output. Bit delay relative to main output:

704 kb/s, 2 Mb/s, 8 Mb/s, 34 Mb/s:

O/P 2 - 4 bits

O/P 3 - 8 bits

O/P 4 - 12 bits

140 Mb/s: No bit delay.

MEASUREMENTS and ANALYSIS

Test timing: Manual, single fixed, timed start

Timed start: Single test period starts at a preset time.

Duration: 1 hour, 24 hours, 72 hours, 7 days, user-defined

User-defined: 1 to 99 - seconds, minutes, hours, days

General Information

Specifications

Real-time clock: Date, time and elapsed test time.

Trouble Scan: Up to four prioritised non-zero error results are displayed in extra-large characters.

Received frequency: Frequency in Hz, resolution 1 Hz

Offset from internal clock rate (ppm), (Hz)

UNFRAMED PDH (Option UKK)

Out of Service analysis Errors:

Bit, Code - error count and ratio.

G.821 analysis: (including Annex D)

Severely errored seconds

Percentage severely errored seconds

Errored seconds

Percentage errored seconds

Error-free seconds

Percentage error-free seconds

Unavailability

Percentage unavailability

Unavailable seconds

Degraded minutes

Percentage degraded minutes

Code error seconds

Elapsed time

M.2100 error analysis: Same as G.821 (Bit errors only).

Alarm indication: AIS, signal loss, pattern sync loss, errors present.

Alarm seconds: All the above plus power loss.

In-service frame error analysis:

Errors (all rates): Frame, bit - error count and ratio Code - error count and ratio (not 140 Mb/s) CRC4 - error count and ratio (2 Mb/s only) REBE (E-bits) - error count and ratio (2 Mb/s only)

G.821-type analysis: On frame bit errors (all rates) On CRC errors (2 Mb/s only) On REBE errors (2 Mb/s only)

Spare bit display: At all rates

M.2100 error analysis: Tx error seconds, Tx severely errored seconds, Rx error seconds, Rx severely errored seconds, Unavailability.

Alarm indication:

All rates: AIS, frame loss, signal loss, remote alarm, Errors present.

2 Mb/s only: CAS/CRC multiframe loss, remote multiframe alarm.

Alarm seconds: All the above plus power loss.

STRUCTURED PDH (Option UKJ or UKL)

Errors: Bit, Code, Frame, CRC, REBE - error count and ratio

G.821 analysis - Bit, Frame, CRC REBE

Error count

Severely errored seconds

Percentage severely errored seconds

Errored seconds

Errored seconds Annex D (Bit errors only)

Percentage errored seconds

Error-free seconds

Percentage error-free seconds

Unavailability

Percentage unavailability

Degraded minutes

Percentage degraded minutes

Code error seconds

Elapsed time

M.2100 error analysis: TX Error seconds, RX error seconds. TX severely errored seconds, RX severely errored seconds, TX unavailability, RX unavailability.

General Information

Specifications

PDH M.2110 error analysis: 2 hour BIS result, 24 hour BIS result, 7 day BIS result.

PDH M.2120 error analysis): TX 15 minute threshold report, RX 15 minute threshold report, TX 24 hour threshold report, RX 24 hour threshold report.

Alarm indication: AIS, signal loss, pattern sync loss, frame loss, remote alarm, multiframe loss, errors present.

Error analysis per ITU-T G.826: Errored seconds, Severely errored seconds, Unavailable seconds, Path unavailable seconds, Errored second ratio, Severely errored second ratio.

In addition Errored blocks and Background block error ratio if 2 Mb/s is selected. If framed all above for NEAR end and FAR end.

Alarm indication: Signal loss, pattern loss, AIS, frame loss, multiframe loss remote alarm/FERF, remote multiframe alarm.

Alarm seconds: Power loss, AIS, signal loss, pattern loss, 140 Mb/s frame loss, 34 Mb/s frame loss, 8 Mb/s frame loss, 2 Mb/s frame loss, RAI, multiframe loss, remote multiframe alarm.

Alarm Scan: The interface rate and all lower levels in the hierarchy are scanned for occurrences of AIS, frame loss and RAI. Any occurrence of these alarms is displayed in graphical form.

Round trip delay: Measures up to 2 seconds delay between transmit and receive.

Resolution: - 10 s

Option 110 Results

Frequency measurement: Frequency displayed in Hz, 1 Hz resolution. Offset displayed in ppm and Hz.

Error results: DS1 (counts & ratios): Bit, B8ZS/AMI code violations, frame errors, CRC6 errors.

DS3 (counts & ratios): Bit, B3ZS code violations, frame errors, P-parity, CP-parity, FEBE.

E1 (counts & ratios): Bit, HDB3/AMI code violations, frame errors, CRC4, REBE.

E3 (counts & ratios): Bit, HDB3 code violations, frame error.

Alarm indication: DS1:LOS, pattern loss, AIS, OOF, Multiframe Loss, RAI, EXZ, Idle

DS3:LOS, Pattern Loss, AIS, OOF, Multiframe Loss, RAI, EXZ, Idle

E1: LOS, Pattern Loss, AIS, LOF, RAI, RMFAI, CASMFL

E3: LOS, Pattern Loss, AIS, LOF, RAI

FEAC code indication: With C-Bit parity framing loopback and alarm/status codes are decoded and displayed. Displays shows current and last active FEAC message.

G.826 analysis: Errored blocks (EB), errored seconds (ES), severely errored seconds (SES), unavailability seconds (UAS), error second ratio (ESR), severely errored second ratio (SESR), background block error ratio (BBER), path unavailable seconds (PUAS).

G.821 analysis (not DS1 and DS3): EC, SES, %SES, ES, %ES, EFS, %EFS, unavailability, %unavailability, degraded minutes, (%)degraded

General Information

Specifications

minutes, code error seconds, elapsed (including Annex D for bit errors)

M.2100, M.2101, M.2110 and M2120 analysis: Tx ES, Tx SES, Rx ES, Rx SES, unavailability

M.2110 bringing into service test: 2 hour, 24 hour and 7 day PASS/-?-/FAIL indication. Run a 24 hour out-of-service test using a PRBS. After 24 hours the instrument compares ES, SES and UAS results against the S1 and S2 thresholds derived from the path llocation and flags either PASS/-?-/FAIL. The 7 day test is then performed on uncertain paths (-?-) during the 24 hour test, i.e. run contiguously for a further 6 days.

M.2120 in-service test for maintenance: Contiguous 15 minute (T1) and 24 hour (T2) periods with TR1 and TR2 threshold reports. Based on the user entered path allocation and maintenance factors, the T1-ES, T1-SES, T2-ES and T2-SES thresholds are calculated. A single threshold report (TR1 for 15 minute, TR2 for 24 hour) is generated when any of the relevant thresholds are exceeded within each 15 minute or 24 hour period.

Signaling monitor: DS1: Signaling bit state is displayed. ABCD format for ESF and AB for SF/SLC-96. SLC-96 can display one of three states; 0,1 or alternating. E1: Graphical display, simultaneously showing the ABCD signalling status of all 30 channels is available.

Alarm scan: Alarms at the Interface Rate and at all lower levels in the hierarchy are scanned continuously. A

graphical picture of the hierarchy is shown which displays the alarm state for all streams.

SDH (Option US1)

Error results: RSOH BIP-8 (B1), MSOH BIP-24 (B2), POH BIP-8 (B3), Path FEBE, VC-3 Path BIP, VC-3 FEBE, VC-5 BIP-2, VC-5 FEBE, Bit (PDH Payload), Frame (A1,A2), MS FEBE, AU-4 path IEC, TU-2 path FEBE, TU-2 path BIP.

Error analysis per ITU-T G.826: For all the errors listed above. Errored seconds, Errored seconds ratio, Severely errored seconds, Errored blocks, Unavailable seconds, Block error count, Severely errored seconds ratio, background block error ratio. (G.821 and M.2100/M.2110/M.2120 for PDH payload)

Alarm indication: Loss of signal (LOS), loss of frame (LOF), loss of pointer (LOP), MS and path AIS, pattern loss, MS FERF, Path FERF, TU path AIS, TU path FERF, clock loss and errors (any type).

Alarm seconds: Loss of power, Loss of Signal, Loss of frame, Out of frame, Loss of pointer, MS and path AIS, K1/K2 change, MS and path FERF, H4 multiframe, TU loss of pointer, TU path AIS, TU path FERF.

Pointer results: AU pointer value, NDF seconds, Missing NDF seconds, +ve Adjustment count, +ve Adjustment seconds, -ve Adjustment count, -ve Adjustment seconds, Implied offset; for both AU and TU.

Overhead BER measurement: Error count, error ratio, error free seconds and % error free seconds.

Specifications

Option A1T

Error results: B1, B2, AU-4 path BIP-8 (B3), AU-4 path FEBE, TU-3 path BIP-8 (B3), TU-3 path FEBE, TU-12 path FEBE, TU-12 path BIP (V5), bit errors (PDH payload). Frame (A1A2), MS FEBE, AU-4 path IEC, TU-2 path FEBE, TU-2 path BIP (V5).

Error analysis: To ITU-T G.826 (G.821 and M.2100/2110/2120 for PDH payload).

Pointer results: AU pointer value, AU NDF seconds, AU missing NDF seconds, AU +ve adjustment count seconds, AU -ve adjustment count/seconds, implied VC-4 offset, TU pointer value, TU NDF seconds, TU missing NDF seconds, TU +ve adjustment count/seconds, TU -ve adjustment count/seconds.

Alarm indication: LOS, LOF, OOF, LOP (AU-4, TU-3, TU-12), MS AIS, MS FERF, path AIS (AU-4), path FERF (AU-4), TU path AIS (TU-3, TU-12), TU path FERF (TU-3, TU-12), pattern sync loss, clock loss and errors (any type).

LOP (TU-2), K1/K2 change, H4 multiframe sync, TU path AIS (TU-2), TU path FERF (TU-2).

Alarm seconds: As for alarm indication, plus power loss, NDF and missing NDF, and except clock loss.

Frequency measurement: Frequency displayed in Hz, 1 Hz resolution. Offset displayed in ppm and Hz.

Received overhead snapshot:

SOH and POH of a received STM-1 signal. Text message displayed for signal label (C2 and V5) and sync status (S1) decoded.

Overhead sequence capture:

Any one overhead channel is selected. After a manual or programmed trigger, the captured byte values are displayed together with the number of consecutive frames containing the value.

AU-4 pointer location graph:

A graphical display that shows the variation with time of the pointer location. Up to four days of pointer location activity can be monitored. Implied VC offset: The total positive and negative pointer movements since the start of the measurement period are summed and the implied mean VC offset calculated from this total.

Overhead BER measurement:

Any RSOH, MSOH or POH (except A1, A2, H1, H2, Z1, Z2) channel is selected and a BER measurement is performed using a 2^9-1 PRBS inserted into a 64 kb/s channel. Single errors can be added to the test pattern. Error count, error ratio, error free seconds, % error free seconds and pattern loss seconds are measured.

Option A3R Results

Error results: Frame (A1A2), B1, B2, MS REI, AU-4 path BIP (B3), AU-4 path REI, AU-4 path IEC, AU-3 path BIP (B3), AU-3 path REI, AU-3 path IEC, TU-3 path BIP (B3), TU-3 path REI,

General Information

Specifications

TU-2 path BIP (V5), TU-2 path REI, TU-12 path BIP (V5), TU-12 path REI, TU-11 path BIP (V5), TU-11 path REI, bit errors (bulk filled, PDH payload). AU-3 path BIP (B3), AU-3 path REI, AU-3 path IEC.

DS1/DS3 error results:

Frame error, CRC6 error (DS1 ESF), P-bit parity (DS3), C-bit Parity (DS3 CBP framing), REI (DS3 CBP framing). Bit errors (DS1 and DS3).

Error analysis: To ITU-T G.826 (G.821 and M.2100/2110/2120 for PDH payload).

Alarm indication: LOS, LOF, OOF, MS AIS, MS RDI, K1K2 change AU-3 path AIS, AU-3 path RDI, AU-3 LOP, AU-3 pointer adj AU-4 path AIS, AU-4 path RDI, AU-4 LOP, AU-4 pointer adj TU-3 path AIS, TU-3 path RDI, TU-3 LOP, TU-3 pointer adj TU-2 path AIS, TU-2 path RDI, TU-2 LOP, TU-2 pointer adj TU-12 path AIS, TU-12 path RDI, TU-12 LOP, TU-12 pointer adj TU-11 path AIS, TU-11 path RDI, TU-11 LOP, TU-11 pointer adj H4 multiframe sync loss, pattern sync loss, clock loss, power loss and errors (any type). DS1/DS3 alarm indication: AIS, frame loss, RDI.

Alarm seconds: As for alarm indication, plus NDF, missing NDF and except clock loss.

AlarmScan plus alarm and BIP scan:

Automatically scans the SDH network hierarchy for alarms and BIP errors or alarms only with a graphical display of

the network hierarchy's status including the indication of unequipped channels. Alarms: LOP, path AIS, path RDI, H4 LOM†, TU LOP*, TU path AIS*, TU path RDI.*

† For TU-11, TU-12 and TU-2 structures.

* If applicable.

BIP errors:

AU-4 payloads: VC-4 B3.

AU-3 payloads: VC-3 B3.

TU-3 payloads: VC-4 B3 and VC-3 B3.

TU-2/TU-12/TU-11 payloads:

VC-4/VC-3 B3 and V5 BIP-2.

User selectable BIP error threshold:

Off, > 0, > 10⁻³, > 10⁻⁶.

Protection switch times:

Service disruption test measures error burst length for measurement of protection switch times†.

Accuracy: < 50 ms.

Results: Longest burst length, shortest burst length, last burst length.

Resolution: 1 ms.

† *Service disruption test requires PDH/DSn option UKJ, UKN or 110 to be fitted.*

Pointer results: AU pointer value, AU NDF seconds, AU missing NDF seconds, AU +ve adjustment count/seconds, AU -ve adjustment count/seconds, TU pointer value, TU NDF seconds, TU missing NDF seconds, TU +ve adjustment count/seconds, TU -ve adjustment count/seconds, implied VC-4, VC-3, VC-2, VC-12, VC-11 offer.

General Information

Specifications

Frequency measurement: Frequency displayed in Hz, 1 Hz resolution. Offset displayed in ppm and Hz.

Received overhead snapshot:
SOH can be set in binary or HEX.
SOH and POH of a received STM-1 signal.
SOH and POH of a received STM-0 signal.
Text message displayed for signal label (C2 and V5) and sync status (S1) decoded.

Overhead sequence capture:
Any one overhead channel is selected. After a manual or programmed trigger, the captured byte values are displayed together with the number of consecutive frames containing the value.

Pointer location graph: A graphical display that shows the variation with time of the AU-n and TU-n pointer location. Up to four days of pointer location activity can be monitored. Implied VC offset: The total positive and negative pointer movements since the start of the measurement period are summed and the implied mean VC offset calculated from this total.

Overhead BER measurement:
Any RSOH, MSOH or POH (except A1, A2, H1, H2, Z1, Z2) channel is selected and a BER measurement is performed using a 29 - 1 PRBS inserted into a 64 kb/s channel. Single errors can be added to the test pattern. Error count, error ratio, error free seconds, % error free seconds and pattern loss seconds are measured.

Option 120 Results (for SDH results see A3R)

Error results STS-3c SPE:
Frame (A1A2), B1, B2, REI-L, CV-P (B3), STS-3c SPE REI-L, STS-3c SPE IEC-P. STS-1 SPE CV-P (B3), STS-1 SPE REI-V, STS-1 SPE IEC-P. VT6 CV-V (V5), VT6 REI-V, VT2 CV-V (V5), VT2 REI-V, VT1.5 CV-V (V5), VT1.5 REI-V, bit errors (bulk filled, DSn/PDH payload).

DS1/DS3 error results: Frame error, CRC6 error (DS1 ESF), P-bit parity (DS3), C-bit Parity (DS3 CBP framing), FEBE (DS3 CBP framing). Bit errors (DS1 and DS3).

Error analysis: To ITU-T G.826 (G.821 and M.2100/M.2101/2110/2120 for DSn/PDH payload).

Alarm indication: LOS, LOF, SEF, AIS-L, RDI-L, K1K2 change STS-3c SPE path AIS, STS-3c SPE RDI-P, STS-3c SPE LOP, STS-3c SPE pointer adj STS-1 SPE path AIS, STS-1 SPE RDI-P, STS-1 SPE LOP, STS-1 SPE pointer adj VT6 path AIS, VT6 RDI-V, VT6 LOP, VT6 pointer adj VT2 path AIS, VT2 RDI-V, VT2 LOP, VT2 pointer adj VT1.5 path AIS, VT1.5 RDI-V, VT1.5 LOP, VT1.5 pointer adj H4 multiframe sync loss, pattern sync loss, clock loss, power loss and errors (any type).
DS1/DS3 alarm indication: AIS, frame loss, RDI.

Alarm seconds: As for alarm indication, plus NDF, missing NDF and except clock loss.

General Information

Specifications

AlarmScan plus alarm and BIP scan:

Automatically scans the SONET network hierarchy for alarms and BIP errors or alarms only with a graphical display of the network hierarchy's status including the indication of unequipped channels. Alarms: LOP, path AIS, RDI-P, H4 LOM†, VT LOP*, AIS-V*, RDI-V.*

† For VT6, VT2 AND VT1.5 structures.

* If applicable.

BIP errors:

STS-3c SPE payloads: STS-3c SPE CV-P (B3).

STS-1 SPE payloads: STS-1 SPE CV-P (B3).

VT6 /VT2 /VT1.5 payloads: STS-3c SPE/STS-1 SPE B3 and CV-V (V5).

User selectable BIP error threshold: Off, > 0, > 10-3, > 10-6.

Protection switch times: Service disruption test measures error burst length for measurement of protection switch times†. Accuracy: < 50 ms. Results: Longest burst length, shortest burst length, last burst length. Resolution: 1 ms.

† Service disruption test requires PDH/DSn option UKJ, UKN or 110 to be fitted.

Pointer results: STS Path pointer value, NDF-P seconds, STS Path missing pointer, NDF seconds, STS Path +ve adjustment count/seconds, STS Path -ve adjustment count/seconds, VT pointer value, NDF-V seconds, VT pointer missing NDF -V seconds, VT +ve adjustment count/seconds, VT -ve adjustment count/

seconds, implied STS-3c SPE, STS-1 SPE, VT6 SPE, VT2 SPE offset.

Frequency measurement: Frequency displayed in Hz, 1 Hz resolution. Offset displayed in ppm and Hz.

Received overhead snapshot:

TOH can be set in binary or HEX. TOH and POH of a received STM-1 signal. TOH and POH of a received STS-1 signal. Text message displayed for signal label (C2 and V5) and sync status (S1) decoded.

Overhead sequence capture:

Any one overhead channel is selected. After a manual or programmed trigger, the captured byte values are displayed together with the number of consecutive frames containing the value.

Pointer location graph: A graphical display that shows the variation with time of the STS Path and VT pointer location. Up to four days of pointer location activity can be monitored. Implied SPE offset: The total positive and negative pointer movements since the start of the measurement period are summed and the implied mean SPE offset calculated from this total.

Overhead BER measurement: Any SOH, LOH or POH (except A1, A2, H1, H2, Z1, Z2) channel is selected and a BER measurement is performed using a 2^9-1 PRBS inserted into a 64 kb/s channel. Single errors can be added to the test pattern. Error count, error ratio, error free seconds, % error free seconds and pattern loss seconds are measured.

General Information

Specifications

JITTER (Options UHN, A1M, A1N, A1P, A3L, A3V and A3N)

Results: Jitter hit count, Jitter hit seconds, Jitter hit free seconds, +ve peak amplitude, -ve peak amplitude, peak-peak amplitude. Additional Results with Options A3L, A3V and A3N. Jitter Transfer and RMS Jitter.

Jitter Autotolerance: After a swept jitter tolerance measurement (using Option UHK or A3K, Jitter Generation) the results are presented graphically to show measured jitter against the ITU-T mask.

Jitter Transfer (option A3L, A3V, A3N only): After a Jitter Transfer measurement (using Option UHK or A3K, Jitter Generation) the results are presented in Graph form to show Jitter Gain against the ITU-T Pass mask and in text form to show the result at each frequency and amplitude point.

Alarm indication: Jitter unlock and Jitter hits

WANDER

Results: +ve peak amplitude, -ve peak amplitude, peak-peak amplitude, peak-peak amplitude 15 minutes, peak-peak amplitude 24 hours, Time interval error, Estimated frame slips, Estimated bit slips. The Wander measurements are available in graphical form on the RESULTS display. Three +ve and -ve sliding graphs, each of ± 1 UI, ± 16 UI and ± 256 UI are provided.

Alarms: No reference and excess wander. If Wander is >5 UI then the status message “Excess Wander” is displayed and is updated once/minute.

ATM Measurement (Option UKN)

Error results Physical Layer:

2.048 Mb/s: CRC4 (ITU-T Rec. G826), REBE (ITU-T Rec. G826). 34.368 Mb/s, 139.264 Mb/s: EM BIP (ITU-T Rec. G826), FEBE (ITU-T Rec. G826).

155.52 Mb/s, 622.08 Mb/s: RS B1 BIP, MS B2 BIP, MS FEBE, Path B3 BIP, Path FEBE, Path IEC (Opt A1T only), per ITU-T Rec. G826.

Error Results ATM Layer:

All rates: Received cells, Corrected HEC, Non-corrected HEC, Cell loss, Errored cells, Non Conforming cells Misinserted cells, Mean Cell Transfer Delay, Maximum cell delay, pk_pk 2 Pt cell delay variation, Maximum 1 Pt cell delay variation, Bit.

Error analysis per ITU-T G.826:

Errored Blocks, Errored seconds, Severely errored seconds, Unavailable seconds, Path unavailable seconds, Block error count, Error second ratio, Severely errored second ratio, Background block error ratio for CRC4, REBE, EM BIP, FEBE, RS B1 BIP, MS B2 BIP, MS FEBE, Path B3 BIP, Path IEC and Path FEBE.

Alarm indication Physical Layer:

2.048, 34.368 and 139.264 Mb/s: Signal Loss, Pattern Loss, AIS, Frame Loss, Multiframe Loss, Remote Alarm/ FERF, Remote Multiframe Alarm.

155.52 Mb/s, 622.08 Mb/s: Loss of Signal, Pattern loss, Loss of pointer, Frame Loss, MS and path FERF, MS and path AIS, TU path AIS, TU path FERF.

General Information

Specifications

Alarm indication ATM Layer (All rates): Loss of cell sync, Selected cell not received, VP alarm, VC alarm.

Alarm seconds Physical Layer:

2.048 Mb/s, 34.368 Mb/s, 139.264 Mb/s: Power Loss, Loss of Signal, Loss of Frame, AIS, FERF, RAI.

155.52 Mb/s, 622.08 Mb/s: Loss of power, Loss of Signal, Loss of frame, Out of frame, Loss of pointer, MS and

path AIS, K1/K2 change, MS and path FERF, H4 multiframe, TU loss of pointer, TU path AIS, TU path FERF.

Alarm seconds ATM Layer (All rates): Power Loss, Loss of cell sync, Selected cell not received, Congestion experienced, Test cell loss, Pattern Loss, PM OAM loss, VP AIS, VP FERF, VP LOC, VC AIS, VC FERF, VC LOC.

ETSI/ANSI Internal Transmitter Clock Rates (Option UKZ)

Rates and Frequency

DS1: 1.544Mb/s:

DS3: 44.736Mb/s

E1: 2.048Mb/s

E3: 34.368Mb/s

Accuracy: DS1 ± 0.7 ppm @ 25C

DS3, E1 and E3 DS1 ± 0.5 ppm @ 25C

Temperature stability at all rates:
 ≤ 3 ppm (0 to +50C)

Ageing Stability at all rates:
 ≤ 1 ppm/year

ETSI/ANSI Transmitter Output Level and Waveshape (Option UKZ)

Rate	Frequency	Level	Waveshape
DSX-1	1.544Mb/s	3.0V 20%	Fits mask T1.102-1993
DS1-LO	1.544Mb/s		As DSX-1 with 655' ABAM Cable
DS3-HI	44.736Mb/s	0.9V pk (nominal)	
DSX-3	44.736Mb/s	560mV pk (nominal)	Fits mask T1.102-1993
DS3-900	44.736Mb/s	330mV pk (nominal)	
E1 (bal)	2.048Mb/s	3.00V 10%	As per ITU rec G703
E1 (unbal)	2.048Mb/s	2.37V 10%	As per ITU rec G703
E3	34.368Mb/s	1.0V 10%	As per ITU rec G703

General Information

Specifications

ETSI/ANSI Receiver Equalization (Option UKZ)

Bit Rate	Cable Loss Accommodation
2.048Mb/s	Up to 6dB for root f cable @ half-bit rate
34.368Mb/s	Automatic equalization up to 12dB for root f cable @ half-bit rate
1.544Mb/s (DS1)	Signal range from DS1-LO to DSX-1
44.736Mb/s (DS3)	Automatic equalization for up to 900 feet of type 728A Cable (root f)

ETSI/ANSI Receiver Monitor Levels (Option UKZ)

Bit Rate	Cable Loss Accommodation (Monitor mode)	Monitor Gain
2.048Mb/s (Unbalanced Mode)	Selectable OFF or Automatic (Up to 6dB for root f cable @ half-bit rate).	Selectable 20dB, 26dB or 30dB
2.048Mb/s (Balanced Mode)	Selectable OFF or Automatic - Up to 6dB (20dB selected) or 3dB (26 or 30dB selected) for root f cable @ half-bit rate.	Selectable 20dB, 26dB or 30dB
34.368Mb/s	Selectable OFF or Automatic (Up to 12dB for root f cable @ half-bit rate)	Selectable 20dB or 26dB
1.544Mb/s (DS1)	Signal range from DS1-LO to DSX-1	Selectable 20dB, 26dB or 30dB
44.736Mb/s (DS3)	Selectable OFF or Automatic (Up to 900 feet of type 728A Cable (root f)	Selectable 20dB or 26dB

General Information

Specifications

GRAPHICS and LOGGING

Graphic display or printout:

Bar chart (results versus 60 time periods) for current or stored measurement period.

Bar resolution: 1 second, 1, 15, 60 minutes.

Unframed PDH bar graphs: Bit error count, code error count, frame error count, CRC error count, REBE error count and PDH alarms.

Structured PDH bar graphs: Bit error count, code error count, 140M frame error count, 34M frame error count, 8M frame error count, 2M frame error count, CRC error count, REBE error count, M2120 Reports and SPDH alarms.

If Option A1T or A3R (SDH) is fitted bar graphs of DS3 frame count, DS1 frame count, P-bit count and C-bit count are available.

SDH bar graphs: RS B1 BIP error count, MS B2 BIP error count, MS FEBE error count, Path B3 BIP error count, Path FEBE error count, Path IEC error count, TU BIP error count, TU FEBE error count and SDH alarms.

Jitter bar graphs: Jitter hit count and Jitter alarms.

Wander bar graphs: Frame slip count and Bit slip count.

ATM bar graphs: EM BIP count, FEBE error count, CRC4 error count, REBE error count, Corrected HEC count, Non corrected HEC count, Non conforming cell count, Bit error count, Cell loss count, Misinserted cell count,

Errored cell count, BEDC count and ATM alarms.

Printer

Internal: 24-column thermal printer.

External: 80-column HP 550C Deskjet printer (HP-IB).

HP 550C Deskjet printer or 40 column or 80 column printer (RS-232-C).

HP 550C Deskjet printer or 40 column or 80 column printer (Centronix)

Printing: Results, time, date and instrument control settings.

Print triggers: Power up, manual, start of test period, turning printer on during test period, any alarm or error second, start of new day.

Print period: 10 minutes, 1 hour, 24 hours, user-defined (10 to 99 minutes or 1 to 99 hours).

Disk Drive:

Configurations: Save/recall of instrument configurations to/from floppy disk drive (in addition to the 5 internal stored settings).

Graphics: Save/recall of stored measurement graphics to/from floppy disk drive. Extends internal event based storage from 20,000 events to 320,000 events.

Logging: Direction of logging output to floppy disk drive.

PC results format: Save SMG stored results in a CSV (comma separated variable) PC compatible format for importing to PC spreadsheets etc.

Disk management: Provides the following disk drive features:

General Information

Specifications

Copying of stored measurement graphics files from internal instrument storage to floppy disk drive.

Copying of instrument configuration files to/from internal instrument storage to/from floppy disk drive.

Deleting files or directories from floppy disk drive.

Renaming of files.

Labeling of floppy disks.

Formatting of floppy disks.

Allows the upgrading of instrument firmware from the floppy disk drive.

General Information
Recommended Test Equipment

Recommended Test Equipment

Instrument	Critical Specification	Recommended Model
Oscilloscope	400 MHz Bandwidth, 1 M Ω Input Termination	HP 54503A
Spectrum Analyzer	200 MHz Bandwidth, 75 Ω Input, -70 to +20 dBm	HP 8568B Opt 001
Frequency Synthesizer	75 Ω Output, Sinewave to 80 MHz, Amplitude to 2.5 V pk-pk, 1 Hz resolution	HP 3335A Opt 001
Frequency Synthesizer	Sinewave to 2.5 MHz, Amplitude to 5V pk-pk, 1 Hz Resolution	HP 3325B (Qty 2)
Signal Generator	Sinewave 700 kHz to 170 MHz, Amplitude 500 mV	HP 8657B
Frequency Counter	Range 0 to 200 MHz, 2 channels with accuracy <0.1ppm. (Ratio Mode)	HP 5335A Opt 010
Optical Power Meter and Sensor Module	Range -8 dBm to -15 dBm, Wavelength 1270-1340 nm	HP 8153A and HP 81536A
Dual Power Supply	$\pm 12V$	HP 6253A
Lightwave Receiver	Wavelength 1300 to 1560 nm, Conversion Gain 750 volts/watt, Frequency Response < 3 dB down at 1 GHz.	HP 83422A
Optical Attenuator	Wavelength 1200 - 1600 nm, Range 0 - 30 dB	
FC/PC Optical Interface Connector	Unique	HP 81000FI
Optical Cables	Unique	HP 11871A (Qty 2)
Digital Transmission Analyzer	Unique	HP 3764A Option 006
PDH Structured Test Set	Unique	HP 37717B/C Opt UKJ
Digital Transmission Frame Generator	Unique	HP 37729A
Jitter Generation Module	Unique	HP 37717B/C Opt UHK
ThinkJet Printer	HP-IB Interface	HP 2225A
Attenuator	6 dB, 50 Ω , 0 to 200 MHz	HP 8491A Opt 006

General Information
Recommended Test Equipment

Instrument	Critical Specification	Recommended Model
DS1 Test Set	Unique	HP 37701B
Attenuator	3 dB, 50 Ω , 0 to 200 MHz	HP 8491A Opt 003
Cable Simulator #1	80 metres of 75 Ω coaxial cable	8120-0049 (80 m)
Cable Simulator #2	60 metres of 75 Ω coaxial cable	8120-0049 (60 m)
Cable Simulator #3	70 metres of 75 Ω coaxial cable	8120-0049 (70 m)
Cable Simulator #4	30 metres of 75 Ω coaxial cable	8120-0049 (30 m)
Converter	75 Ω Unbalanced to 120 Ω Balanced	HP 15508C
ECL Termination	Unique	HP 10086A
Blocking Capacitor	0.18 μ f	HP 10240A
Cable Attenuator	Unique	HP 8120-0039 (70 m)
75 Ω /50 Ω Matching Pad	Insertion Loss 5.7 dB	HP 11852B (Qty 2)
75 Ω Termination	0 to 200 MHz	HP 15522-80010
T Connector	BNC to Dual BNC	HP 1250-0781
Adaptor	N Type (f) to BNC (m)	1250-1534 (Qty 2)
Adaptor	N Type (m) to N Type (m)	1250-1475 (Qty 2)
Adaptor	SMA to BNC	1250-1787 (Qty 2)
RS-232-C Loopback	Unique (See Figure 3-1)	5060-4462
Cable Simulator #5	450 feet of type 728A Cable (root f)	Unique (see Appendix D)
Cable Simulator #6	655 feet ABAM Cable	Unique (see Appendix D)
Balanced/Unbalanced Converter 2-off required	110 Ω s balanced: 75 Ω s Unbalanced (nominal)	HP 15508B
Impedance Converter	75/ 50 Ω Insertion Loss 5.7dB	HP 11852B

Installation

Initial Inspection

WARNING

TO AVOID HAZARDOUS ELECTRICAL SHOCK, DO NOT PERFORM ELECTRICAL TESTS WHEN THERE ARE SIGNS OF SHIPPING DAMAGE TO ANY PORTION OF THE OUTER ENCLOSURE (COVERS, PANELS, METERS).

Inspect the shipping container for damage. If the shipping container or cushioning material is damaged, it should be kept until the contents of the shipment have been checked for completeness and the instrument has been checked both mechanically and electrically. Procedures for checking electrical operation are given in the Calibration manual. If the contents of the shipment are incomplete, if there is mechanical damage or defect, notify the nearest Hewlett-Packard Office. If the instrument does not pass the electrical performance tests given in the Calibration manual, notify the nearest Hewlett-Packard office. If the shipping container is also damaged, or the cushioning material shows signs of stress, notify the carrier as well as the nearest Hewlett-Packard office. Keep the shipping materials for the carrier's inspection. The Hewlett-Packard office will arrange for repair or replacement without waiting for claim settlement.

Operating Environment

This instrument is designed for Indoor use only.

DO NOT operate the product in an explosive atmosphere or in the presence of flammable gasses or fumes.

This instrument may be operated in environments within the following limits:

Temperature: 0° C to +45° C

+5° C to +35° C with lid printer

Altitude up to 3050m (10,000ft)

Humidity up to 95% relative humidity to 40° C but it should be protected from temperature extremes which may cause condensation.

To ensure adequate cooling do not obstruct air vents in the instrument cabinet.

CAUTION

This instrument is designed for use in Installation Category II and Pollution Degree 2 per IEC 1010 and 644 respectively.

CAUTION

VENTILATION REQUIREMENTS: When installing the instrument in a cabinet, the convection into and out of the instrument must not be restricted. The ambient temperature (outside the cabinet) must be less than the maximum operating temperature of the instrument by 4⁰C for every 100 watts dissipated in the cabinet. If the total power dissipated in the cabinet is greater than 800 watts, then forced convection must be used.

Preparation for Use

WARNING

FOR CONTINUED PROTECTION AGAINST FIRE HAZARD REPLACE FUSE ONLY WITH SAME TYPE AND RATINGS (SEE “Fuses” on page 2-3).

WARNING

If this instrument is not used as specified, the protection provided by the equipment could be impaired. This instrument must be used in a normal condition only (in which all means for protection are intact).

Power Requirements

The HP 37717C Communications Performance Analyzer requires a power source of 90 V to 132 V ac and 198 V to 264 V ac at a frequency between 47 Hz and 63 Hz (nominal).

Total power consumption is 450 VA (maximum).

The fuse rating for the power source is given in the following Table.

Fuses

Line Voltage	Fuse Rating	HP Part Number
90V to 264V	5A Timed, 250V	2110-1120

Fuse Replacement

Only the ac line fuse located at the rear of the instrument may be replaced by the operator.

WARNING

ALL OTHER FUSE REPLACEMENT SHOULD ONLY BE CARRIED OUT BY SUITABLY TRAINED SERVICE PERSONNEL AWARE OF THE HAZARDS INVOLVED.

Installation
Preparation for Use

WARNING

BEFORE REMOVING THE FUSE, THE AC LINE POWER CORD SHOULD BE DISCONNECTED FROM THE POWER SOURCE AND THE OTHER END DISCONNECTED FROM THE INSTRUMENT.

WARNING

ONLY USE A FUSE OF THE CORRECT RATING AS LISTED IN “Fuses” on page 2-3. DO NOT use repaired fuses or short-circuited fuseholders: For continued protection against fire, replace the line fuse(s) only with fuse(s) of the same voltage and current rating and type.

The fuse is removed by inserting a suitable flat bladed tool into the slot in the fuse cap and turning counter-clockwise. The cap and the fuse can then be removed and the fuse changed for another of the correct rating. The fuse rating and HP part number are listed in “Fuses” on page 2-3.

Connecting to the Power Supply

WARNING

This is a Safety Class I instrument (provided with a protective earthing ground, incorporated in the powercord). The mains plug shall only be inserted in a socket outlet provided with a protective earth contact. Any interruption of the protective conductor inside or outside of the instrument is likely to make the instrument dangerous. Intentional interruption is prohibited.

Line Voltage Selector Switch

The Line Voltage Selector switch has 2 positions:

- 100 - 120V
- 200 - 240V

CAUTION

Before switching on this instrument, make sure that the line voltage selector switch is set to the voltage of the power supply. Ensure the supply voltage is in the specified range.

Installation
Preparation for Use

Power Cord

WARNING

TO AVOID THE POSSIBILITY OF INJURY OR DEATH, THE FOLLOWING PRECAUTIONS MUST BE FOLLOWED BEFORE THE INSTRUMENT IS SWITCHED ON:-

WARNING

(a) Note that the protection provided by grounding the instrument cabinet may be lost if any power cable other than the three-pronged type is used to couple the ac line voltage to the instrument.

WARNING

(b) If this instrument is to be energized via an auto-transformer to reduce or increase the line voltage, make sure that the common terminal is connected to the neutral pole of the power source.

WARNING

(c) The power cable plug shall only be inserted into a socket outlet provided with a protective ground contact. The protective action must not be negated by the use of an extension cord without a protective conductor (grounding).

The power cord supplied with each instrument varies with the country of destination. The following figure illustrates the standard power plug and cord configurations that are commonly used. The part number shown beneath each plug is the part number of the appropriate power cord and plug. If the appropriate power cord is not included with the instrument notify the nearest Hewlett-Packard office and a replacement will be provided.

Power Cord Configurations and Part Numbers

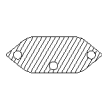
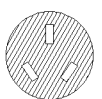
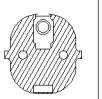
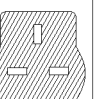
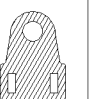
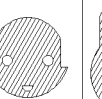
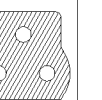
						
8120-2104	8120-1369	8120-1689	8120-1351	8120-1378 US 8120-4753 JAP	8120-2956	8120-4211

Connecting to the Network

The network connectors are located on the modules at the side of the instrument. The connections available depend on the options fitted to your instrument.

Before Connecting, note the Warning and Caution information given.

All Connectors

CAUTION

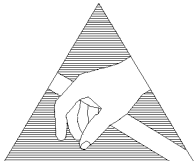

When connecting or disconnecting, ensure that you are grounded or, make contact with the metal surface of the Mainframe with your free hand to bring you, the module, and the mainframe to the same static potential.

Modules remain susceptible to ESD damage while the module is installed in the Mainframe

Additional ESD information is required when servicing see “Additional Precautions for Service Engineers” on page 2-18

Electrical Interface Connectors

PDH IN

PDH receiver input interface. Allows the connection of 75 Ω unbalanced data signals (all rates) and 120 Ω balanced data signals at 2 Mb/s (and 704 kb/s Option UKK[USB]).

PDH OUT

PDH transmitter output interface. Provides 75 Ω unbalanced data output (all rates) and 120 Ω balanced data output at 2 Mb/s (and 704 kb/s Option UKK[USB]).

DS3, 2Mb/s, 34Mb/s 75 Ω IN

PDH/DSn receiver input interface. Allows the connection of 75 Ω unbalanced DS3, 2 Mb/s and 34.368 Mb/s data signals.

DS3, 2Mb/s, 34Mb/s 75 Ω OUT

PDH / DSn transmitter output interface. Provides 75 Ω unbalanced DS3, 2 MB/s and 34 Mb/s data output. A “keep alive” signal is output when the transmit signal is SDH/SONET.

Installation

Connecting to the Network

<i>DS1 100 Ω, 2Mb/s 120 Ω IN</i>	PDH / DS1 receiver input interface. Allows the connection of 100 Ω balanced DS1 and 120 Ω balanced 2 Mb/s data signals.
<i>DS1 100 Ω, 2Mb/s 120 Ω OUT</i>	PDH / DS1 transmitter output interface. Provides 100 Ω balanced DS1 and 120 Ω balanced 2 Mb/s data signals. A “keep alive” signal is output when the transmit signal is SDH/SONET.
<i>75 Ω OUT 1</i>	Replica of PDH / DS _n OUT delayed by 4 bits at all rates except 140 Mb/s.
<i>75 Ω OUT 2</i>	Replica of PDH / DS _n OUT delayed by 8 bits at all rates except 140 Mb/s.
<i>75 Ω OUT 3</i>	Replica of PDH / DS _n OUT delayed by 12 bits at all rates except 140 Mb/s.
<i>ERROR OUT</i>	Provides an ECL pulse each time an error occurs. If 2 or more errors occur within 16 clock periods only 1 pulse is output.
<i>STM-1 IN</i>	SDH receiver input interface. Allows the connection of 75 Ω unbalanced STM-1 electrical signals.
<i>STM-1 OUT</i>	SDH transmitter output interface. Provides a 75 Ω unbalanced STM-1 electrical output.
<i>EXT MTS CLOCK</i>	Allows connection of a, 75 Ω or 120 Ω, timing reference as per CCITT G.811. The reference format may be either clock or data. Options US1[US5] and A1T[A1U] only.
<i>CLOCK IN</i>	Allows connection of SDH/SONET binary clock to Options 130 or 131.
<i>CLOCK OUT (Opt OYH)</i>	Provides a STM-1/STM-4 binary clock from Options USN or UKT.

Installation

Connecting to the Network

<i>CLOCK OUT (Opt 110)</i>	Outputs the selected transmitter clock (internal or looped receiver clock). Note that this output is turned OFF when the TRANSMIT module is supplying payload to the SDH module.
<i>DATA IN</i>	Allows connection of SDH/SONET binary data to Options 130 or 131.
<i>DATA OUT</i>	Provides SDH/SONET binary data from Options 130 or 131.
<i>MUX</i>	Allows the insertion of an external 2 Mb/s tributary into the transmitted payload.
<i>MUX DS1 100 Ω</i>	Allows an externally supplied DS1 signal to be inserted in any or all timeslot(s) of a DS3 signal. In conjunction with the SDH/SONET module a DS1 signal can be inserted into a VT1.5 or TU-11.
<i>MUX 2 Mb/s 75 Ω</i>	Allows an externally supplied 2.048 Mb/s signal to be inserted in any or all timeslot(s) of a 34 Mb/s signal. In conjunction with the SDH module a 2.048 Mb/s signal can be inserted into a TU-12.
<i>DEMUX (Opt UKJ)</i>	Provides a 2 Mb/s tributary dropped from the received payload.
<i>DEMUX DS1 100 Ω</i>	Allows a DS1 signal to be dropped from any timeslot of a DS3 signal. In conjunction with the SDH/SONET module this port allows the demultiplexing of a DS1 signal carried in a VT1.5
<i>DEMUX 2 Mb/s 75 Ω</i>	Allows a 2.048 Mb/s signal to be dropped from any timeslot of an 8.448 Mb/s, 34.368 Mb/s or 139.264 Mb/s signal.
<i>STM-1E IN</i>	Allows connection of STM-1 electrical input for SDH Jitter Measurement.

Installation

Connecting to the Network

STM-1 / STM-4 IN Allows connection of STM-1 / STM-4 optical input for SDH Jitter Measurement.

2M REF IN Allows the connection of a 2 Mb/s reference, either Clock or Data for Wander measurement.

DEMOD OUT Provides a demodulated Jitter output.

TRIG OUT Not used in option 110 instruments.

RS 449 Allows the Drop and Insert of Regenerator Section (192 kb/s) and Multiplexer Section (576 kb/s) Data Communication Channels (DCC).

The following connections are available:

Pin Number	Connection
4	Send Data (A)
5	Send Timing (A)
6	Receive Data (A)
8	Receive Timing (A)
19	Signal Ground (Chassis)
22	Send Data (B)
23	Send Timing (B)
24	Receive Data (B)
26	Receive Timing (A)

Optical Interface Connectors

For your protection, review all laser information given in this manual before installing or using the instrument.

WARNING



To prevent personal injury, avoid use that may be hazardous to others, and maintain the module in a safe condition. Ensure the information given below is reviewed before operating the module.

Laser Product Classification

All Options UH1, UH2, URU, USN, 130, 131 and UKT are classified as Class I (non-hazardous) laser product in the USA which complies with the United States Food and Drug Administration (FDA) Standard 21 CFR Ch.1 1040.10. Options UH1 and UH2 are classified as Class 1 (non-hazardous) laser products in Europe which complies with EN 60825-1 (1994).

Options URU, USN, 130 and 131 are classified as a Class 3A laser product in Europe, which complies with EN 60825-1 (1994) / IEC825-1(1993).

Laser classification is based on the ability of the optical beam to cause biological damage to the eye or skin. The EN 60825-1 (1994) definition of Class 3A is:

"Any laser product which permits human access to laser radiation in excess of the accessible emission limits of Class I and Class 2 as applicable, but which does not permit human access to laser radiation in excess of the accessible emissions of Class 3A and Class 3B (respectively) for any emission duration and wavelength."

Options URU, USN, 130 and 131 fall into this category, under the EN 60825-1 (1994) (European) standard, because they have a maximum output power of 19.5 mW (under fault conditions), with a wavelength of 1550 nm.

To avoid hazardous exposure to laser radiation, it is recommended that the following practices are observed during system operation:

- **ALWAYS DEACTIVATE THE LASER BEFORE CONNECTING**

Connecting to the Network

OR DISCONNECTING OPTICAL CABLES.

- When connecting or disconnecting optical cables between the module and device-under-test, observe the connection sequences given below.

Connecting: Connect the optical cable to the input of the device-under-test **before** connecting to the module's *Optical Out* connector.

Disconnecting: Disconnect the optical cable from the module's *Optical Out* connector **before** disconnecting from the device-under-test. Always ensure the shutter closes properly and covers the laser aperture.

- NEVER examine or stare into the open end of a broken, severed, or disconnected optical cable when it is connected to the module's *Optical Out* connector.
- Arrange for service-trained personnel, who are aware of the hazards involved, to repair optical cables.

CAUTION

1. Use of controls or adjustments or performance of procedures other than those specified herein may result in hazardous radiation exposure.

2. Always leave the fibre optic connector dust caps on each connector when not in use. Before connection is made, *always* clean the connector ferrule tip with acetone or alcohol and a cotton swab. Dry the connector with compressed air. Failure to maintain cleanliness of connectors is liable to cause excessive insertion loss.

Laser Warning Symbols

The front panel of optical modules **Options UH1 and UH2** has the following label:

CLASS 1 LASER PRODUCT

This label indicates that the radiant energy present in this instrument is non-hazardous.

The front panel of optical modules **Options URU, UKT and USN** has the following label:

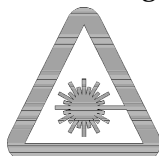

Installation
Connecting to the Network

The front panel of optical modules **Options 130 and 131** has the following label



CLASS 3A LASER PRODUCT

WARNING

Direct intrabeam viewing of Class 3A laser beams with optical aids (e.g. binoculars, telescopes) may be hazardous. For laser emitting in the range from 400nm to 700nm, protection to the unaided eye is afforded by aversion responses including the blink reflex.

Swedish and Finnish Labels

VARO! NÄKYMÄTÖNTÄ LASERSÄTEILYLLE
ÄLÄ TUIJOTA SÄTEESEEN ÄLÄKÄ KATSO SITÄ
OPTISEN LAITTEEN LÄPI
LUOKAN 3A LASERLAITE

VARNING - OSYNLIG LASERSTRÅLNING
STIRRA ET IN I STRÅLEN OCH BETRAKTA EJ
STRÅLEN MED OPTISKA INSTRUMENT
CLASS 3A LASER PRODUCT

VARNING - OSYNLIG LASERSTRÅLNING
STIRRA ET IN I STRÅLEN OCH BETRAKTA EJ
STRÅLEN GENOM OPTISKT INSTRUMENT
KLASS 3A LASER APPARAT

Installation
Connecting to the Network

Location of Laser Apertures on Options 130 and 131

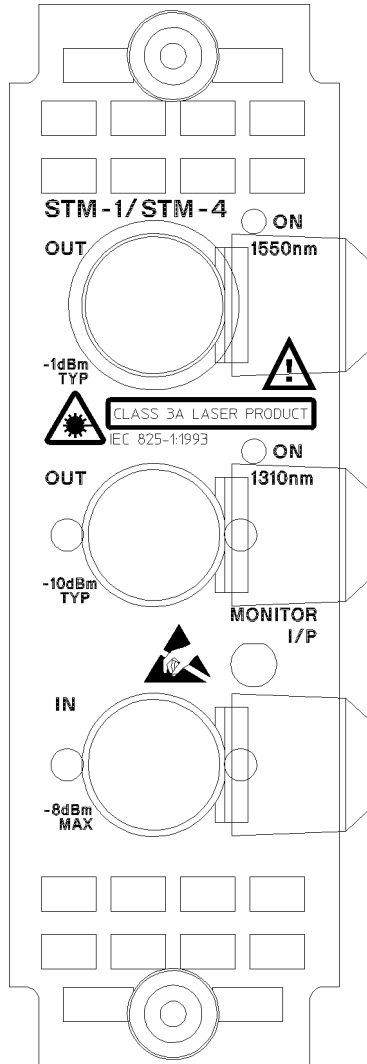

Installation

Connecting to the Network

OPTICAL IN

Allows connection of an optical signal, wavelength 1200 to 1600 nm, at a maximum power level of -8 dBm.

Option UH1 accepts STM-1.

Options 130 and 131 accept STM-0, STM-1 or STM-4 and also SONET signals, STS-1, STS-3 and STS-12.

OPTICAL OUT

Provides an STM-0, STM-1 or STM-4 optical signal (STS-1, STS-3 and STS-12 SONET signals).

Option UH1 provides a STM-1 optical signal, wavelength 1280 to 1330nm, at a nominal power level of -10 dBm.

Options 130 and 131 provide an STM-0 STM-1 and STM-4 optical signal, wavelength 1280 to 1330 nm, at a nominal power level of -10 dBm.

Option 131 also provides a STM-1 and STM-4 optical signal, wavelength 1550 to 1565 nm, at a nominal power level of -1 dBm.

Cleaning Optical Connectors

See “Optical Connector Cleaning” on page 1-12

Connecting Accessories

LID	Provides the output for the option UKX printer which is fitted in the cover (LID) of the instrument.
VGA	Provides the output for a display monitor.
HANDSET	Allows connection of a telephone handset for communication across the network.
Printer HP-IB, RS232, PARALLEL ONLY	External printer connection details are given in the Users Guide. The port selected for external printer use is not available for remote control.
Remote Control HP-IB, RS232, 10 BASE -T	Remote control connection is given in the Remote Control Manual. The port selected for remote control use is not available for an external printer.

10 Base-T Lan Connection Radiated Emissions

To ensure compliance with EN 55011 (1991) a category 5, FTP patch lead, RJ45 cable should be used to connect the LAN port on the processor module marked "10 Base-T".

Installation
Connecting Accessories

Hewlett-Packard Interface Bus

The HP 37717C Communications Performance Analyzer (Option A3B or A3D) is connected to the HP-IB by means of an appropriate HP-IB cable. The HP-IB interconnecting cables available are listed in the following table.

HP-IB Interconnecting Cables

Length	Accessory Number
1 meter	HP 10833A
2 meters	HP 10833B
4 meters	HP 10833C
0.5 meter	HP 10833D

To achieve interface design performance standards, restrictions are placed on the HP-IB system cable lengths. These restrictions allow the bus interface electronics to maintain correct line voltage levels and timing relationships.

When connecting an HP-IB system the following rules should be observed:

The total HP-IB cable length used must be less than or equal to 20 meters (65.6 feet).

The total HP-IB cable length used must be less than or equal to 2 meters (6 feet) × the total number of devices connected to the bus.

A standard HP-IB connector is provided on the instrument . The connections are shown in the following figure. The mating connector part number is HP 1251-0293 or Amphenol 57-30240.

Installation
Connecting Accessories

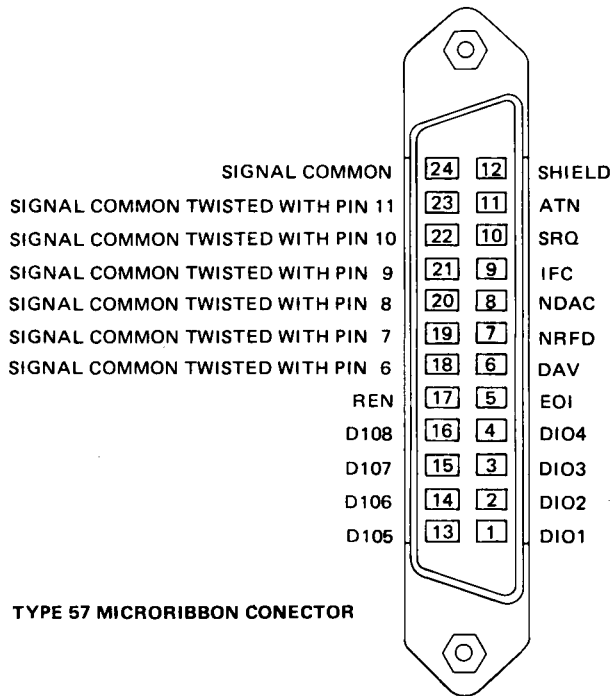

HP-IB Connections

HP-IB Address Selection

The HP 37717C (Option A3B or A3D) HP-IB address is accessed on the OTHER display under the REMOTE CONTROL function.

The address can be set to any value between 0 and 30 inclusive .

Additional Precautions for Service Engineers

Safety Precautions

DO NOT substitute parts or modify equipment: Because of the danger of introducing additional hazards, do not install substitute parts or perform any unauthorized modification to the product. Return the product to a Hewlett-Packard Sales and Service Office for service and repair to ensure the safety features are maintained.

DO NOT service or adjust alone: Under certain conditions, dangerous voltages may exist even with the equipment switched off. To avoid dangerous electrical shock, service personnel must not attempt internal service or adjustment unless another person, capable of rendering first aid and resuscitation, is present.

Review “Safety Precautions for the Operator” on page 1-9

ESD Precautions

CAUTION

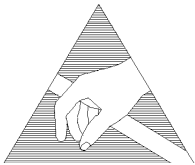

When making connections to the modules, review “Connecting to the Network” on page 2-6

The module contains components sensitive to electrostatic discharge. To prevent component damage, carefully follow the handling precautions presented below.

The smallest static voltage most people can feel is about 3500 volts. It takes less than one tenth of that (about 300 volts) to destroy or severely damage static sensitive circuits. Often, static damage does not immediately cause a malfunction but significantly reduces the component's life. Adhering to the following precautions will reduce the risk of static discharge damage.

- Keep the module in its conductive storage box when not installed in the Mainframe. Save the box for future storage of the module.
- Before handling the module, select a work area where potential static sources are minimized. Avoid working in carpeted areas and non-conductive chairs. Keep body movement to a minimum. Hewlett-Packard

Installation

Additional Precautions for Service Engineers

- recommends that you use a controlled static workstation.
- Handle the module by its front-panel. Avoid touching any components or edge connectors. When you install the module, keep one hand in contact with the protective bag as you pick up the module with your other hand. Then, before installing the module, ensure that you are grounded or make contact with the metal surface of the Mainframe with your free hand to bring you, the module, and the mainframe to the same static potential. **This also applies whenever you connect/disconnect cables on the front-panel.**

Installation

Additional Precautions for Service Engineers

Performance Tests

Introduction

The procedures given in this Section, test the HP 37717C electrical performance using the Specifications listed in Section 1, General Information, as performance standards. Each test is self contained and, therefore, may be performed as a stand-alone test or as part of full instrument calibration.

Equipment Required

Equipment required for the Performance Tests is listed in Chapter 1, General Information. Any equipment which meets or exceeds the critical specification of the equipment listed, may be substituted.

Extra Modules Required

Some of the Performance Tests require additional modules to be present in the instrument under test. Before starting Performance Tests, refer to Appendix B to decide if you need to fit any extra modules.

Performance Test Record

The results of the Performance Tests may be recorded on the Performance Test Record at the end of this Section. The Performance Test Record lists all the tested specifications and the acceptable limits. The results recorded at incoming inspection may be used for comparison during periodic maintenance, troubleshooting or after repair or adjustment.

Calibration Cycle

This instrument requires periodic verification of performance. Depending on use and environmental conditions, the instrument should be checked approximately once a year, using these Performance Tests.

Performance Tests

Introduction

Recall Default Settings

The Performance Tests require the HP 37717C to be set to a pre-defined (default) state at the beginning of each test. The pre-defined default settings are listed in Appendix A.

1. Using **OTHER**, display softkeys, **↓**, **↑**, **→** and **←** set up the **OTHER** **STORED SETTINGS** display as shown opposite.

2. Press **RECALL** to recall the instrument default settings. The instrument display will blank for a few seconds while the settings are recalled and the status display will indicate stored settings number 0 recalled.

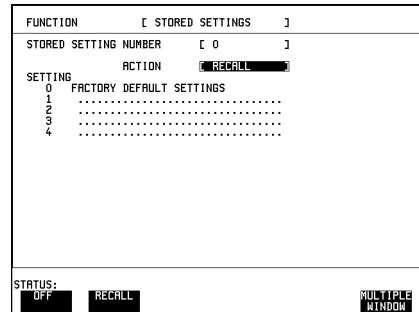

Self Test - All Options

Description

The instrument ALL TESTS self test is run to verify the functionality of the instrument prior to carrying out the performance tests.

Ensure the following loopbacks are in place before running the ALL TESTS Self Test.

1. Set up the **OTHER** display as shown opposite using **OTHER**, **MORE** and **SELF TEST**

2. Insert a formatted disk into the instrument disk drive

3. PDH Loopbacks:

Connect 75 Ω Signal In to 75 Ω Signal Out.

Connect 120 Ω Signal In to 120 Ω Signal Out.

If Option UKJ is fitted, also connect MUX port to DEMUX port.

If Option UH3 is fitted connect CLOCK OUT to CLOCK IN and DATA OUT to DATA IN.

4. SDH Loopbacks:

Connect the STM-1 IN port to the STM-1 OUT port.

5. Optical Interface Loopbacks:

Connect the IN port to the OUT Port.

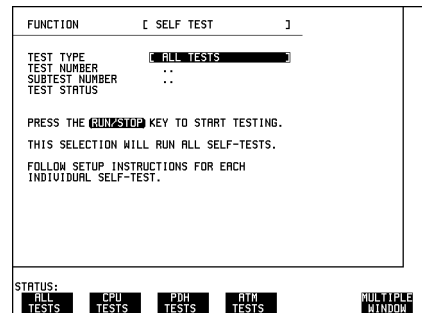

CAUTION

If Option URU, STM-1/STM-4 Optical Interface, is fitted connect an Optical attenuator, set to 10 dB, between the IN and OUT Ports. **Failure to attenuate the optical signal from option URU could result in damage to the optical receiver.**

NOTE

If Option USN or UKT, Dual Wavelength Optical Interface, is fitted connect the **1310 nm** OUT port to the IN port. Do not connect the **1550 nm** OUT port to the IN port.

Performance Tests

Self Test - All Options

NOTE

If any or all of these connections are not made the HP 37717C will FAIL Self Test.

6. Press **RUN/STOP** to activate the Self Test. TEST STATUS [RUNNING] will be displayed. The information pertaining to TEST TYPE, TEST NUMBER and SUBTEST NUMBER will change as the Self Test progresses

If the HP 37717C is functioning correctly, after a time of between 15 minutes and 1 hour, TEST STATUS [PASSED] is displayed.

If TEST STATUS [FAIL nnn] is displayed the HP 37717C should be returned to a service office for repair.

FAIL Error Numbers are listed and defined in Appendix B.

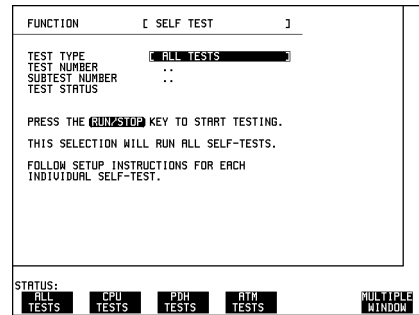

Additional Tests

Some options require additional test to be carried out to completely verify the option integrity. These require different connections and the tests run individually.

RS-232-C Tests: If Option A3B or A3D is fitted, the RS-232-C interface is not fully tested.

To fully test RS-232-C:

1. Select CPU TESTS
2. Fit a special RS-232-C connector with Loopback links as shown:

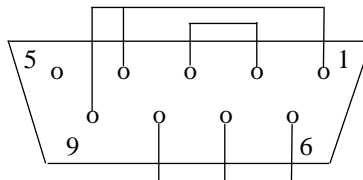

3. Run the CPU TESTS.

Performance Tests

Self Test - All Options

Line Jitter Tests: If Option A3L, A3V, A3N, A1M, A1N or A1P, SDH Line Jitter, is fitted the full set of jitter tests are not included under ALL TESTS.

To fully test SDH Line Jitter:

1. Select JITTER TESTS
2. Connect STM-1 OUT from the SDH module to STM-1E IN on the RX Jitter module.
3. For Options A1N and A1P only connect STM-1/STM-4 OUT on the Optical Module to STM-1/STM-4 IN on the RX Jitter module.
4. RUN the JITTER TESTS.

1550 nm Dual Wavelength Tests: If Option USN, 130 Dual Wavelength Optical Interface, is fitted the 1550 nm tests are not included under ALL TESTS.

To complete the 1550 nm tests:

1. Select STM-1/STM-4 OPTICS TESTS
2. Connect STM-1/STM-4 1550 nm OUT to STM-1/STM-4 1550 nm IN via an Optical Attenuator set to 10 dB.
3. RUN the STM-1/STM-4 OPTICS TESTS.

Datacomm Tests: If Option A1T[A1U] or A3R [A3S], 120 SDH/SONET Module, is fitted the Datacomm RS449 port is not tested under ALL TESTS

To test the Datacomm port:

1. Select SDH TESTS
2. Make the following connections on the Datacomm port.



Self Test Datacomm port loopback connections

3. RUN the SDH TESTS.

PDH Internal Transmitter Clocks (Options UKK, [USB], UKJ, [USA])

Specifications

Bit Rate	Option	Specification
139.264 MHz	UKJ, [USA], UKK, [USB]	139.264 MHz \pm 626.28 Hz
34.368 MHz	UKJ, [USA], UKK, [USB]	34.368 MHz \pm 154.66 Hz
8.448 MHz	UKJ, [USA], UKK, [USB]	8.448 MHz \pm 38.0 Hz
2.048 MHz	UKJ, [USA], UKK, [USB]	2.048 MHz \pm 9.22 Hz
704 kHz	UKK, [USB]	704 kHz \pm 3.17 Hz

Description

This test verifies that the PDH transmit data rates are within limits. These limits assume the instrument is within the annual calibration cycle. The Frequency Offset capability (deviation from Standard Bit Rate) is also tested here.

The test uses a Frequency Counter connected to the PDH Signal Out port to measure the data rate on an "all ones" pattern. This gives an indirect measure of the internal transmitter clock frequency as the data is clocked by the internal clock oscillator. Because the Frequency Counter triggers from the positive pulses only, the frequency count will be half the selected data rate.

Equipment Required

Frequency Counter : HP 5335A Option 010

75 Ω Termination : HP 15522-80010

T Connector : HP 1250-0781

Performance Tests

PDH Internal Transmitter Clocks (Options UKK, [USB], UKJ, [USA])

Procedure

1. Recall the HP 37717C DEFAULT SETTINGS as shown on 3-2.
2. Connect the 75 Ω Unbalanced SIGNAL OUT port to the Frequency Counter. Terminate the Frequency Counter input in 75 Ω (use the T connector).
3. Set the frequency counter to:

FUNCTION - FREQ A

ATTEN - X10

NOTE

Steps 4 and 5 are only valid for Option UKK, [USB].

4. Press **TRANSMIT** and set up the display as shown opposite.
5. Adjust the Frequency Counter ATTEN and Trigger Level to obtain a stable reading and ensure that the Frequency Counter reads between 351997.53 Hz and 352002.46 Hz.
6. Select SIGNAL [2 Mb/s], adjust the Frequency Counter ATTEN and Trigger Level to obtain a stable reading and ensure that the Frequency Counter reads between 1023992.8 Hz and 1024007.2 Hz.
7. Select signal [8 Mb/s], adjust the Frequency Counter ATTEN and Trigger Level to obtain a stable reading and ensure that the Frequency Counter reads between 4223970.4 Hz and 4224029.6 Hz.
8. Select SIGNAL [34 Mb/s], adjust the Frequency Counter ATTEN and Trigger Level to obtain a stable reading and ensure that the Frequency Counter reads between 17183879.7 Hz and 17184120.3 Hz.
9. Select SIGNAL [140 Mb/s], adjust the Frequency Counter ATTEN and Trigger Level to obtain a stable reading and ensure that the Frequency Counter reads between 69631512.6 Hz and 69632487.4 Hz.

TRANSMITTER OUTPUT	[PDH]
PDH TEST FUNCTION	
SIGNAL	[704 kb/s]
CLOCK SYNC	[INTERNAL]
FREQUENCY OFFSET	[OFF]
CODE	[HDB3]
PATTERN	[ALL ONES]
TERMINATION	[75 Ω UNBAL]
STATUS:	
MULTI-FUNCTION WINDOW	

Performance Tests

PDH Internal Transmitter Clocks (Options UKK, [USB], UKJ, [USA])

Frequency Offsets

10. Press **TRANSMIT** and set up the display as shown opposite.

11. Adjust the Frequency Counter ATTEN and Trigger Level to obtain a stable reading and ensure that the Frequency Counter reads between 69632557.05 Hz and 69633531.91 Hz.

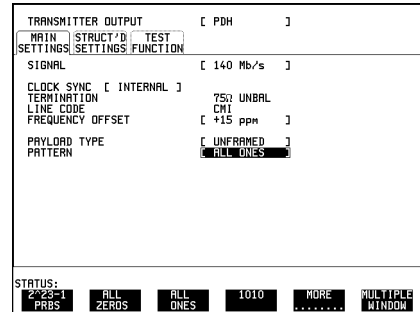

NOTE

At each step wait for the Status message "VCXO output Bit Rate settling" to clear from the bottom line of the display before reading the frequency counter.

12. Select TX CLOCK OFFSET: [-15PPM], adjust the Frequency Counter Trigger Level to obtain a stable reading and ensure that the Frequency Counter reads between 69630642.18 Hz and 69631268.86 Hz.

13. Select TX CLOCK OFFSET: [USER OFFSET] [+100PPM] and ensure that the Frequency Counter reads between 69638649.86 Hz and 69639276.54 Hz.

14. Select TX CLOCK OFFSET: [USER OFFSET] [-100PPM], adjust the Frequency Counter Trigger Level to obtain a stable reading and ensure that the Frequency Counter reads between 69624723.46 Hz and 69625350.14 Hz.

15. Select each BIT RATE and TX CLOCK OFFSET listed in Table 3-1.

16. For each selection adjust the Frequency Counter ATTEN and Trigger Level to obtain a stable reading and ensure that the Frequency Counter reads between the limits listed in Table 3-1.

Table 3-1 Transmitter Clock Offset

Bit Rate	Offset	Option	Counter Reading Hz (minimum)	Counter Reading Hz (maximum)
34 Mbit/s	+20 ppm	UKJ, [USA], UKK, [USB]	17184266.35	17184421.01
34 Mbit/s	-20 ppm	UKJ, [USA], UKK, [USB]	17183578.99	17183733.65
8 Mbit/s	+30 ppm	UKJ, [USA], UKK, [USB]	4224107.7	4224145.73
8 Mbit/s	-30 ppm	UKJ, [USA], UKK, [USB]	4223854.27	4223892.29
2 Mbit/s	+50 ppm	UKJ, [USA], UKK, [USB]	1024046.59	1024055.81
2 Mbit/s	-50 ppm	UKJ, [USA], UKK, [USB]	1023944.19	1023953.41
704 kbit/s	+50 ppm	UKK, [USB]	352016.0	352019.18
704 kbit/s	-50 ppm	UKK, [USB]	351980.82	351983.98

PDH Transmitter Output (UKK, [USB], UKJ, [USA])

Specifications

Pulse Shape: As per ITU Rec. G.703

Pulse Amplitude:

120Ω Balanced (704 kb/s & 2 Mb/s) 3.00V ±10%

75Ω Unbalanced (704 kb/s, 2 Mb/s & 8 Mb/s) 2.37V ±10%

75Ω Unbalanced (34 Mb/s) 1.00V ±10%

75Ω Unbalanced (140 Mb/s) 0.50V ±10%

NOTE

704 kb/s is only valid when Option UKK, [USB] is fitted.

Description

This test verifies that the PDH transmitter output level and pulse shape meet required ITU specifications for all rates. The SIGNAL OUT Port is connected to a Digitizing Oscilloscope and the waveform is checked for required amplitude and duty cycle at the nominal mid-points. The waveform shape is also checked by comparison with the special ITU masks. These may be obtained from the oscilloscope memory (if this feature is fitted) or can be traced from the attached figures and compared with a printout of the oscilloscope waveform.

NOTE

A Balanced to unbalanced Converter is required to test the Balanced output port. The 3V peak at the output is reduced to 2.37V peak on the oscilloscope by this device. The oscilloscope must be terminated in 75Ω for both balanced and unbalanced outputs.

Equipment Required

Oscilloscope	: HP 54503A
120W/75W Balanced to Unbalanced Converter	: HP 15508C
ThinkJet Printer	: HP 2225A

Procedure

704 kb/s Unbalanced Output

1. Recall the HP 37717C DEFAULT SETTINGS as shown on Page 3-2.
2. Connect the Unbalanced 75Ω SIGNAL OUT port to the Oscilloscope Input 1 via a 75Ω termination and "T" connector. Set the oscilloscope termination to $1M\Omega$.

NOTE

Steps 3 to 10 are only valid for Option UKK, [USB].

Performance Tests

PDH Transmitter Output (UKK, [USB], UKJ, [USA])

3. Press **TRANSMIT** and set up the display as shown opposite.
4. Press **AUTOSCALE** on the oscilloscope.
5. Adjust the Oscilloscope Timebase and Delay to position the positive peak pulse amplitude at mid-pulse-width point in the centre of the screen.

TRANSMITTER OUTPUT [PDH]	
PDH TEST FUNCTION	
SIGNAL	[704 kb/s]
CLOCK SYNC	[INTERNAL]
FREQUENCY OFFSET	[OFF]
CODE	[AMI]
PATTERN	[USER WORD]
TERMINATION	[1000000000000000] [75Ω UNBAL]
STATUS:	
	MULTIPLE WINDOW

6. Verify the Pulse in Figure 3-1 meets the following criteria:

Pulse Amplitude 2.133V to 2.607V

Pulse Width 639 ns to 781 ns

Overshoot $\leq 0.474V$

Undershoot $\leq 0.474V$

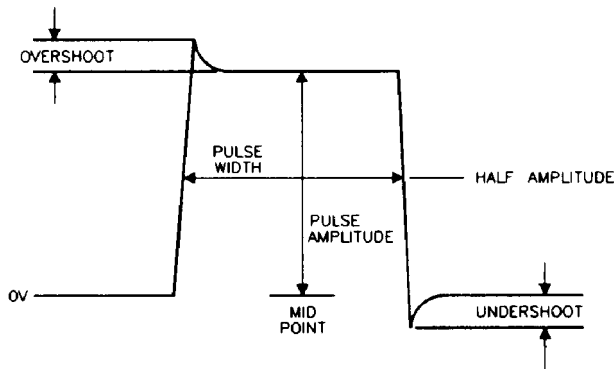

Figure 3-1

704 kb/s Pulse Criteria

7. Adjust the Oscilloscope Delay to position the negative peak pulse amplitude at mid-pulse-width point in the centre of the screen and verify that the negative pulse meets the criteria listed in step 6.

704 kb/s Balanced Output

8. Connect the Balanced to Unbalanced Converter between the HP 37717C 120Ω Balanced SIGNAL OUT port and the Oscilloscope, leaving the 75Ω termination and "T" connector in place.

Performance Tests

PDH Transmitter Output (UKK, [USB], UKJ, [USA])

9. Select TERMINATION [120 Ω BAL] on the **TRANSMIT** display.

10. Repeat steps 4 through 7.

2.048 Mb/s Unbalanced Output

11. Select SIGNAL [2 Mb/s]; TERMINATION [75 Ω UNBAL].

12. Connect the Unbalanced 75 Ω SIGNAL OUT port to the Oscilloscope Input 1. Set the oscilloscope termination to 1M Ω and press **AUTOSCALE** on the oscilloscope.

13. Adjust the Oscilloscope Timebase and Delay to position the positive peak pulse amplitude at mid-pulse-width point in the centre of the screen.

14. Measure the peak pulse amplitude at mid-pulse-width using the Oscilloscope and verify that this is between 2.133V and 2.607V.

15. Select the 2Mb G.703 mask on the oscilloscope and store it on the display.

16. Press SHIFT **AUTOSCALE** on the oscilloscope to automatically align the pulse to the mask in Figure 3-2. Verify that the pulse falls within the mask as shown in Figure 3-3.

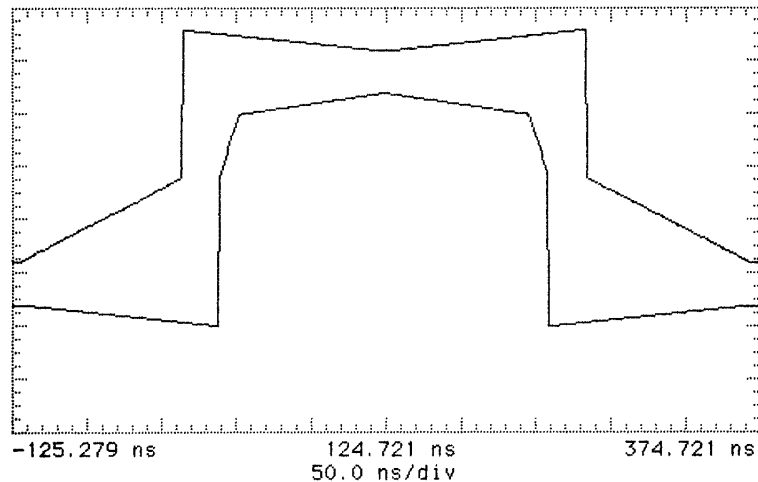

Figure 3-2

2 Mb/s Pulse Mask

NOTE

If your oscilloscope does not have the Mask feature, obtain a printout of the displayed pulse. Place the mask, shown in Figure 3-2, over the pulse and ensure that the pulse falls within the mask. (A transparent copy of the mask should be used).

Performance Tests

PDH Transmitter Output (UKK, [USB], UKJ, [USA])

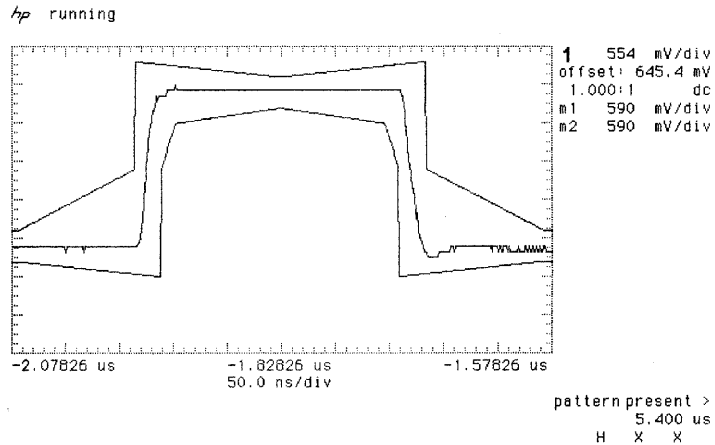

Figure 3-3

2 Mb/s Isolated Positive Pulse

17. Press **AUTOSCALE** on the oscilloscope to display the full waveform.

18. Use the following sequence to display the isolated negative pulse.

- Select **TRIG** menu.
- Set trigger level to middle of negative pulse.
- Set trigger to pattern.
- Set sequence to H X X.

19. Use the oscilloscope **STORE INVERT** to display an inverted mask on the oscilloscope.

20. Adjust the oscilloscope timebase and vertical sensitivity controls to verify that the pulse meets the mask as shown in Figure 3-3. Use the displayed settings as a guide.

21. Measure the peak pulse amplitude at mid-pulse-width using the Oscilloscope and verify that this is between 2.133V and 2.607V.

Performance Tests

PDH Transmitter Output (UKK, [USB], UKJ, [USA])

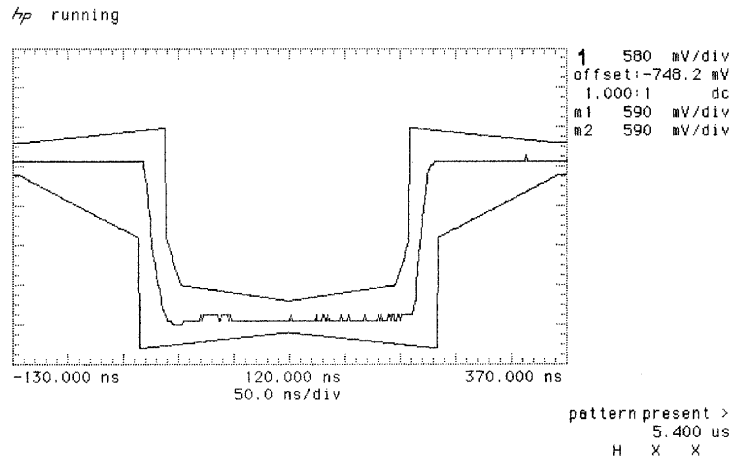

Figure 3-4

2 Mb/s Isolated Negative Pulse

22. Ensure that the ratio of +ve and -ve pulse amplitudes is between 0.95 and 1.05.
23. Ensure that the ratio of +ve and -ve pulse widths is between 0.95 and 1.05.

2.048 Mb/s Balanced Output

24. Connect the Balanced to Unbalanced Converter between the HP 37717C 120 Ω Balanced SIGNAL OUT port and the Oscilloscope.
25. Select TERMINATION [120 Ω BAL] on the **TRANSMIT** display.
26. Repeat steps 13 through 23.

8.448 Mb/s Unbalanced Output

27. Select SIGNAL [8 Mb/s] and TERMINATION [75 Ω UNBAL] on the **TRANSMIT** display.
28. Connect the Unbalanced 75 Ω SIGNAL OUT port to the Oscilloscope Input 1. Set the oscilloscope termination to 1M Ω and press **AUTOSCALE** on the oscilloscope.
29. Select the 8 Mb G.703 mask on the oscilloscope and store it on the display.
30. Repeat steps 13 through 23 to verify the 8 Mb/s unbalanced output.

Performance Tests

PDH Transmitter Output (UKK, [USB], UKJ, [USA])

NOTE

If your oscilloscope does not have the Mask feature, obtain a printout of the displayed pulse. Place the mask, shown in Figure 3-6, over the pulse and ensure that the pulse falls within the mask. (A transparent copy of the mask should be used).

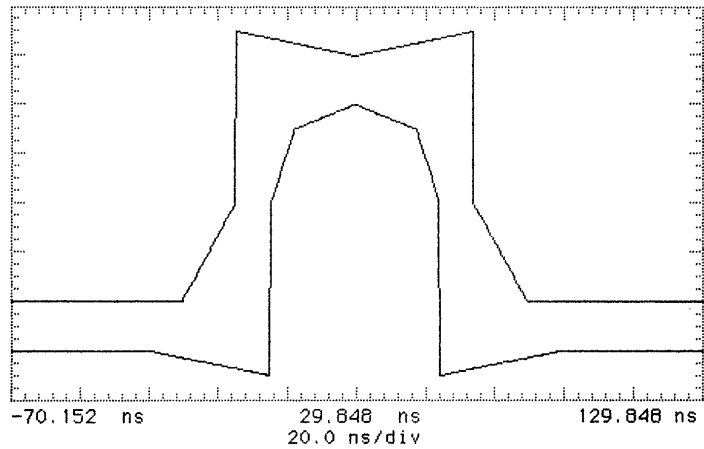

Figure 3-5

8 Mb/s Pulse Mask

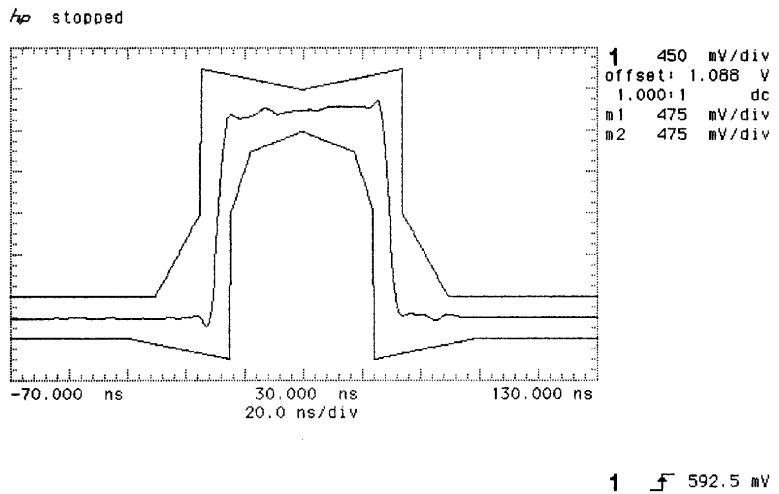

Figure 3-6

8 Mb/s Isolated Positive Pulse

Performance Tests

PDH Transmitter Output (UKK, [USB], UKJ, [USA])

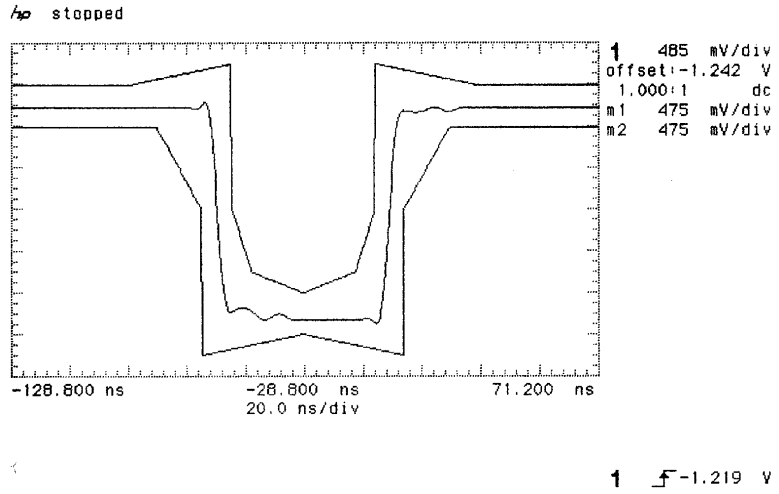

Figure 3-7

8 Mb/s Isolated Negative Pulse

Performance Tests

PDH Transmitter Output (UKK, [USB], UKJ, [USA])

34.368 Mb/s Unbalanced Output

31. Press **TRANSMIT** and set up the display as shown opposite.

32. Press **AUTOSCALE** on the oscilloscope.

33. Select the 34 Mb G.703 mask on the oscilloscope and store it on the display.

34. Repeat steps 13 through 23 (in step 21 ensure the peak pulse amplitude is 0.9V to 1.1V) to verify the 34 Mb/s unbalanced output.

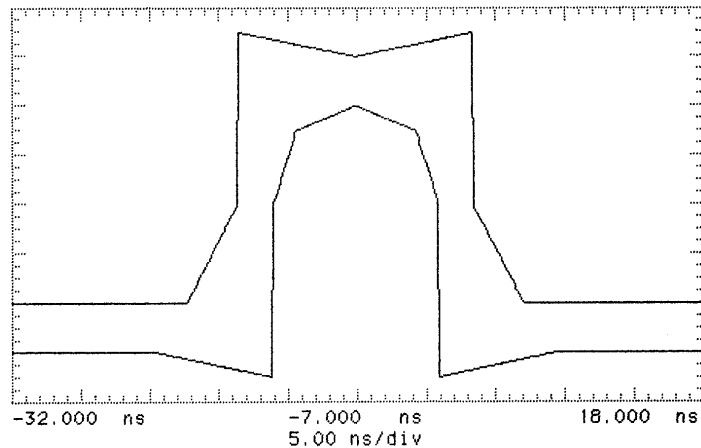
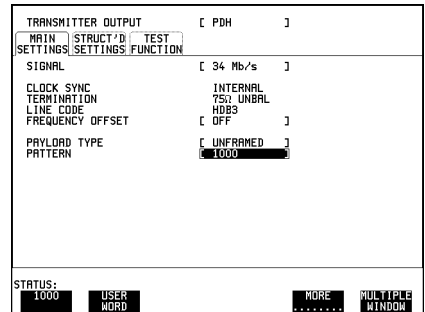

Figure 3-8

34 Mb/s Pulse Mask

NOTE

If your oscilloscope does not have the Mask feature, obtain a printout of the displayed pulse. Place the mask, shown in Figure 3-8, over the pulse and ensure that the pulse falls within the mask. (A transparent copy of the mask should be used).

Performance Tests
PDH Transmitter Output (UKK, [USB], UKJ, [USA])

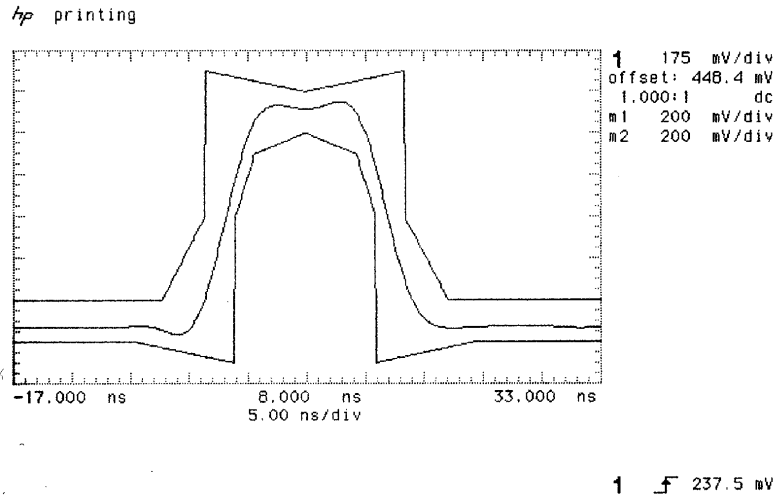

Figure 3-9 34 Mb/s Isolated Positive Pulse

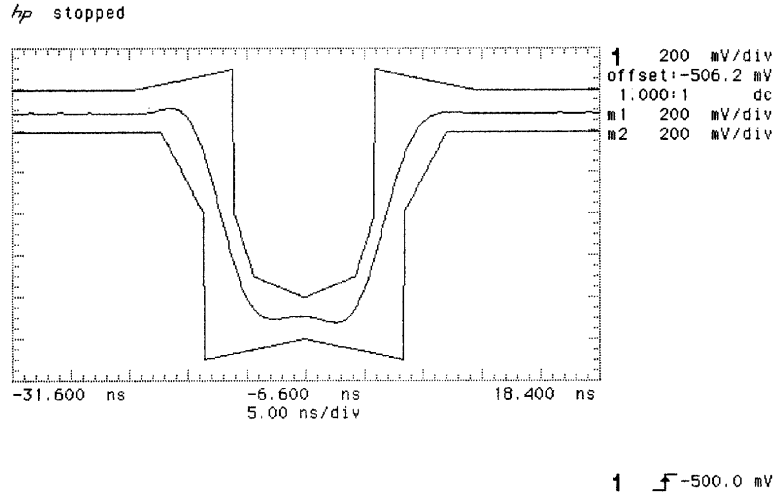

Figure 3-10 34 Mb/s Isolated Negative Pulse

Performance Tests

PDH Transmitter Output (UKK, [USB], UKJ, [USA])

139.264 Mb/s Unbalanced Output

35. Press **TRANSMIT** and set up the display as shown opposite.

36. Press **AUTOSCALE** on the oscilloscope.

37. Select the BIN1 140 Mb G.703 mask on the oscilloscope and store it on the display.

38. Adjust the Oscilloscope Delay to position the positive peak pulse amplitude at mid-pulse-width point in the centre of the screen.

39. Measure the peak pulse amplitude at mid-pulse-width using the Oscilloscope and verify that this is between 0.900V and 1.100V.

40. Press **SHIFT** **AUTOSCALE** on the oscilloscope to automatically align the pulse to the mask. Verify that the pulse falls within the mask as shown in Figure 3-12.

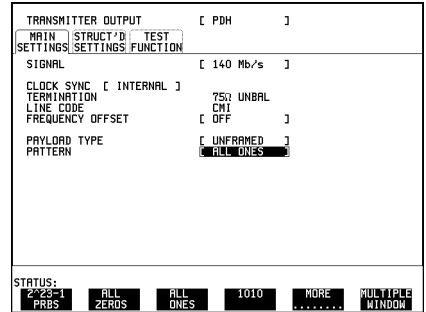

NOTE

If your oscilloscope does not have the Mask feature, obtain a printout of the displayed pulse. Place the mask, shown in Figure 3-11, over the pulse and ensure that the pulse falls within the mask. (A transparent copy of the mask should be used).

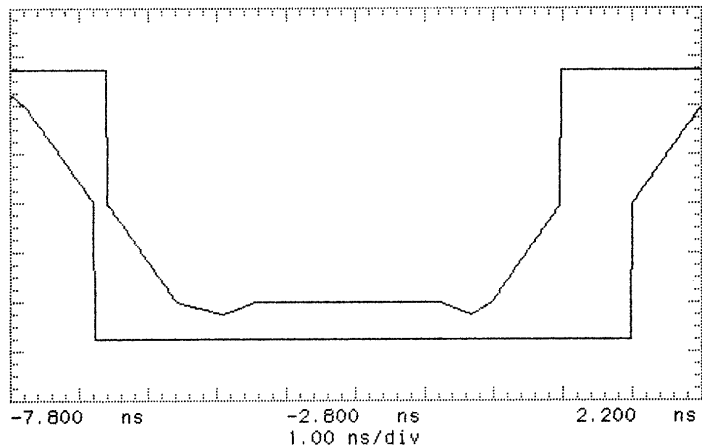

Figure 3-11

140 Mb/s Pulse Mask All 1's

Performance Tests

PDH Transmitter Output (UKK, [USB], UKJ, [USA])

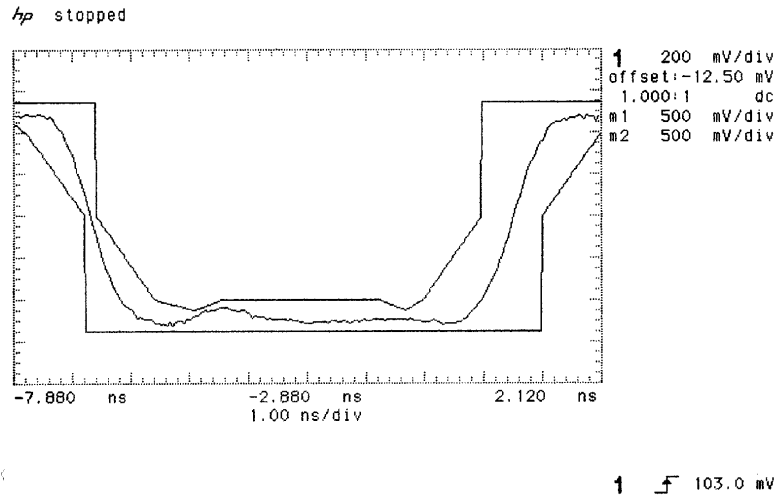

Figure 3-12

140 Mb/s All Ones Pulse

41. Select PATTERN [ALL ZEROS] on the **TRANSMIT** display.
42. Select BIN0 140 Mb/s G.703 mask on the oscilloscope and store it on the display.
43. Adjust the Oscilloscope Delay to position the positive peak pulse amplitude at mid-pulse-width point in the centre of the screen.
44. Measure the peak pulse amplitude at mid-pulse-width using the Oscilloscope and verify that this is between 0.900V and 1.100V.
45. Press SHIFT **AUTOSCALE** on the oscilloscope to automatically align the pulse to the mask. Verify that the pulse falls within the mask as shown in Figure 3-14.

NOTE

If your oscilloscope does not have the Mask feature, obtain a printout of the displayed pulse. Place the mask, shown in Figure 3-13, over the pulse and ensure that the pulse falls within the mask. (A transparent copy of the mask should be used).

Performance Tests

PDH Transmitter Output (UKK, [USB], UKJ, [USA])

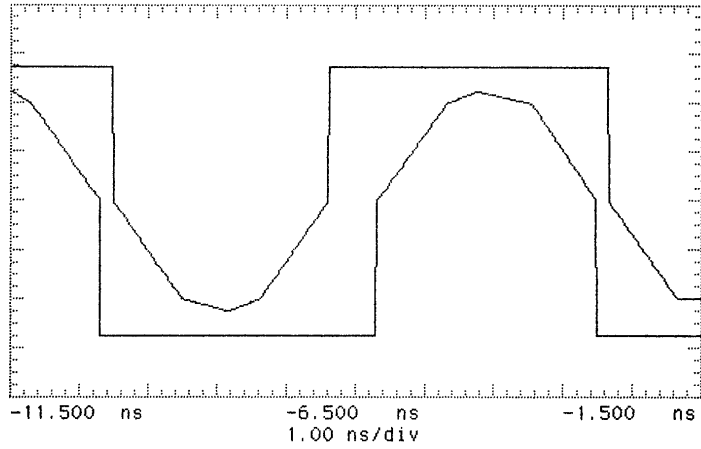

Figure 3-13 140 Mb/s Pulse Mask All 0's

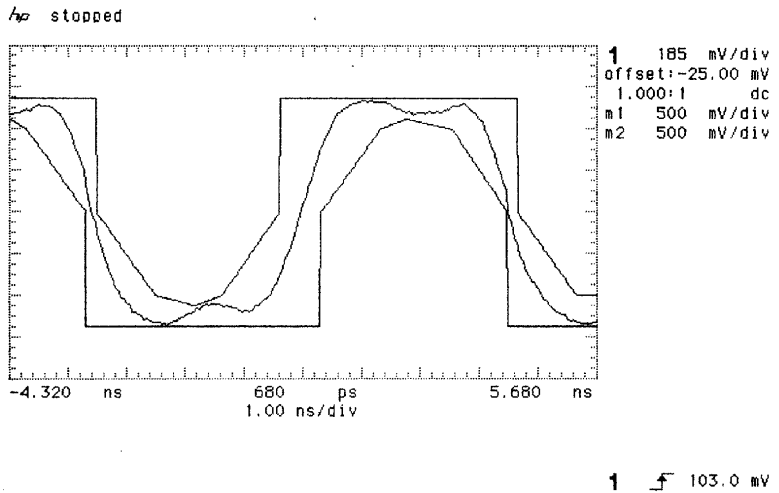

Figure 3-14 140 Mb/s All Zeros Pulse

Multiple PDH Transmitter Outputs (Options UHC, [US6])

NOTE

A PDH Option must be fitted for this option to operate - see Appendix B.

Specifications

Pulse Shape: As per ITU Rec. G.703

Pulse Amplitude:

704 kb/s	2.37V \pm 10%
2 Mb/s	2.37V \pm 10%
8 Mb/s	2.37V \pm 10%
34 Mb/s	1.00V \pm 10%
140 Mb/s	0.50V \pm 10%

Additional Outputs Delay

704 kb/s, 2, 8 and 34 Mb/s	Signal Out 2	4 bits
704 kb/s, 2, 8 and 34 Mb/s	Signal Out 3	8 bits
704 kb/s, 2, 8 and 34 Mb/s	Signal Out 4	12 bits
140 Mb/s	Signal Out 2, 3, 4	No delay

NOTE

704 kb/s is only valid when Option UKK, [USB] is fitted.

Description

This test verifies that the 3 additional PDH transmitter outputs meet ITU pulse shape and level specifications for all rates. Each PDH Signal Out Port is connected to a Digitizing Oscilloscope terminated in 75 Ω and the waveform is checked for required amplitude and duty cycle at the nominal mid-points.

Performance Tests

Multiple PDH Transmitter Outputs (Options UHC, [US6])

The waveform shape is also checked by comparing with the special ITU masks. These may be obtained from the oscilloscope memory (if this feature is fitted) or can be traced from the attached figures and compared with a printout of the oscilloscope waveform. The relative delay at each output is also verified using the second channel of the oscilloscope.

Equipment Required

Oscilloscope	: HP 54503A
120/75Ω Bal/Unbal Converter	: HP 15508C
ThinkJet Printer	: HP 2225A

Procedure

1. Recall the HP 37717C DEFAULT SETTINGS as shown on 3-2.

704 kb/s Output Pulse

2. Connect the **PDH SIGNAL OUT 2** port to the Oscilloscope Channel 1. Set the Oscilloscope termination to 1MΩ.

Steps 3 to 16 are only valid for Option UKK, [USB].

3. Press **TRANSMIT** and set up the display as shown opposite.
4. Press **AUTOSCALE** on the oscilloscope.
5. Adjust the Oscilloscope Timebase and Delay to position the positive peak pulse amplitude at mid-pulse-width point in the centre of the screen.

TRANSMITTER OUTPUT	[PDH]
PDH TEST FUNCTION	[]
SIGNAL	[704 kb/s]
CLOCK SYNC	[INTERNAL]
FREQUENCY OFFSET	[OFF]
CODE	[AMI]
PATTERN	[USER WORD]
TERMINATION	[1000000000000000] [75Ω UNBAL]
STATUS:	
MULTIPLE WINDOW	

Performance Tests

Multiple PDH Transmitter Outputs (Options UHC, [US6])

6. Verify the Pulse meets the following criteria:

Pulse Amplitude 2.133V to 2.607V

Pulse Width 639 ns to 781 ns

Overshoot $\leq 0.474V$

Undershoot $\leq 0.474V$

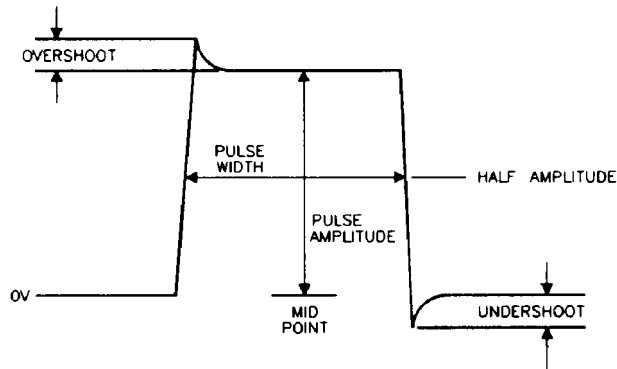

Figure 3-15

704 kb/s Pulse Criteria

7. Repeat steps 5 and 6 with the Oscilloscope Channel 1 connected to **SIGNAL OUT 3** and **SIGNAL OUT 4** in turn.

8. Adjust the Oscilloscope Timebase and Delay to position the negative peak pulse amplitude at mid-pulse-width point in the centre of the screen and verify that the negative pulse meets the criteria listed in step 6.

9. Repeat step 8 with the Oscilloscope Channel 1 connected to **SIGNAL OUT 2** and **SIGNAL OUT 3** in turn.

704 kb/s Additional Outputs Delay

10. Connect the **PDH SIGNAL OUT 1** port to the Oscilloscope Channel 1. Set the Oscilloscope termination to $1M\Omega$.

11. Connect the **PDH SIGNAL OUT 2** port to the Oscilloscope Channel 2. Set the Oscilloscope termination to $1M\Omega$.

12. Check that the pulse on Channel 2 is 4 bits delayed with respect to the pulse on Channel 1.

13. Disconnect the **SIGNAL OUT 2** port from the oscilloscope and connect the **SIGNAL OUT 3** port to the oscilloscope Channel 2.

Performance Tests

Multiple PDH Transmitter Outputs (Options UHC, [US6])

14. Check that the pulse on Channel 2 is 8 bits delayed with respect to the pulse on Channel 1.

15. Disconnect the **SIGNAL OUT 3** port from the oscilloscope and connect the **SIGNAL OUT 4** port to the oscilloscope Channel 2.

16. Check that the pulse on Channel 2 is 12 bits delayed with respect to the pulse on Channel 1.

2.048 Mb/s Output Pulse

17. Connect the **PDH SIGNAL OUT 2** port to the Oscilloscope Channel 1. Set the Oscilloscope termination to $1M\Omega$.

18. Press **TRANSMIT** and set up the display as shown opposite.

19. Press **AUTOSCALE** on the oscilloscope.

20. Adjust the Oscilloscope Timebase and Delay to position the positive peak pulse amplitude at mid-pulse-width point in the centre of the screen.

21. Measure the peak pulse amplitude at mid-pulse-width using the Oscilloscope and verify that this is between 2.133V and 2.607V.

22. Select the 2Mb/s G703 Mask on the oscilloscope and store it on the Display.

23. Press **SHIFT** **AUTOSCALE** on the oscilloscope to automatically align the pulse to the mask. Verify that the pulse falls within the mask as shown in Figure 3-16.

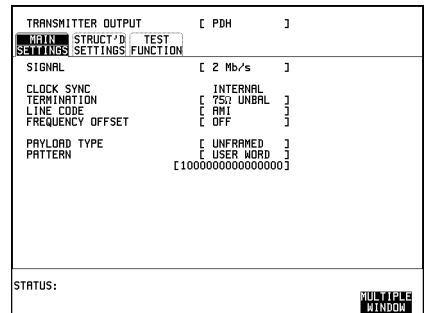

NOTE

If your oscilloscope does not have the Mask feature, obtain a printout of the displayed pulse. Place the mask shown in Figure 3-16 over the pulse and ensure that the pulse falls within the mask (a transparent copy of the mask should be used).

Multiple PDH Transmitter Outputs (Options UHC, [US6])

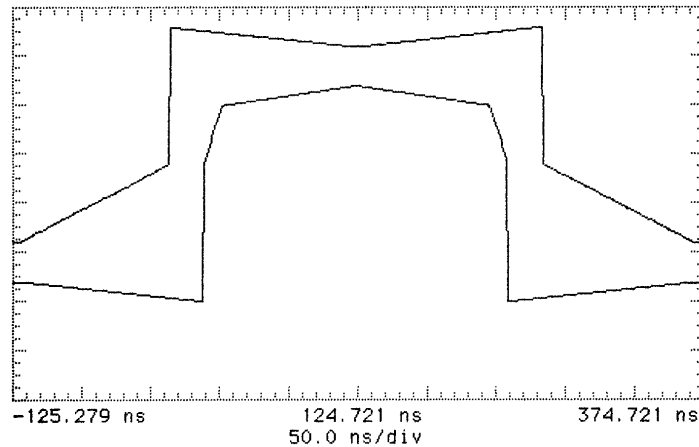

Figure 3-16 **2 Mb/s Pulse Mask**

24. Repeat steps 20 to 23 with the Oscilloscope Channel 1 connected to **SIGNAL OUT 3** and **SIGNAL OUT 4** in turn.

25. Press **AUTOSCALE** on the oscilloscope to display the full waveform and use the following sequence to display the isolated negative pulse:

 Select **TRIG** menu.

 Set trigger level to middle of negative pulse.

 Set Trigger to **PATTERN**.

 Set Sequence to **H X X**.

26. Use the oscilloscope **STORE INVERT** function to display an inverted pulse mask on the oscilloscope.

27. Adjust the oscilloscope timebase, delay and vertical sensitivity controls to verify that the pulse meets the mask as shown in Figure 3-16. Use the displayed settings as a guide.

28. Measure the peak pulse amplitude at mid-pulse-width using the Oscilloscope and verify that this is between 2.133V and 2.607V.

29. Repeat steps 27 and 28 with the Oscilloscope Channel 1 connected to **SIGNAL OUT 2** and **SIGNAL OUT 3** in turn.

Performance Tests

Multiple PDH Transmitter Outputs (Options UHC, [US6])

2.048 Mb/s Additional Output Delay

30. Connect the **PDH SIGNAL OUT 1** port to the Oscilloscope Channel 1. Set the Oscilloscope termination to $1M\Omega$
31. Connect the **PDH SIGNAL OUT 2** port to the Oscilloscope Channel 2. Set the Oscilloscope termination to $1M\Omega$
32. Check that the pulse on Channel 2 is 4 bits delayed with respect to the pulse on Channel 1.
33. Disconnect the **SIGNAL OUT 2** port from the oscilloscope and connect the **SIGNAL OUT 3** port to the oscilloscope Channel 2.
34. Check that the pulse on Channel 2 is 8 bits delayed with respect to the pulse on Channel 1.
35. Disconnect the **SIGNAL OUT 3** port from the oscilloscope and connect the **SIGNAL OUT 4** port to the oscilloscope Channel 2.
36. Check that the pulse on Channel 2 is 12 bits delayed with respect to the pulse on Channel 1.
37. Ensure that the ratio of +ve and -ve pulse amplitudes is between 0.95 and 1.05.
38. Ensure that the ratio of +ve and -ve pulse widths is between 0.95 and 1.05.

8.448 Mb/s Output Pulse

39. Connect the **PDH SIGNAL OUT 2** port to the Oscilloscope Channel 1.

40. Press **TRANSMIT** and set up the display as shown opposite.

41. Press **AUTOSCALE** on the oscilloscope.

42. Adjust the Oscilloscope Timebase and Delay to position the positive peak pulse amplitude at mid-pulse-width point in the centre of the screen.

43. Measure the peak pulse amplitude at mid-pulse-width using the Oscilloscope and verify that this is between 2.133V and 2.607V.

44. Select the 8Mb/s G703 Mask on the oscilloscope and store it on the Display.

45. Press SHIFT **AUTOSCALE** on the oscilloscope to automatically align the pulse to the mask. Verify that the pulse falls within the mask as shown in Figure 3-17.

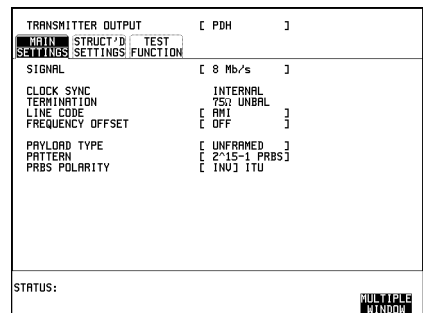

Multiple PDH Transmitter Outputs (Options UHC, [US6])**NOTE**

If your oscilloscope does not have the Mask feature, obtain a printout of the displayed pulse. Place the mask shown in Figure 3-17 over the pulse and ensure that the pulse falls within the mask (a transparent copy of the mask should be used).

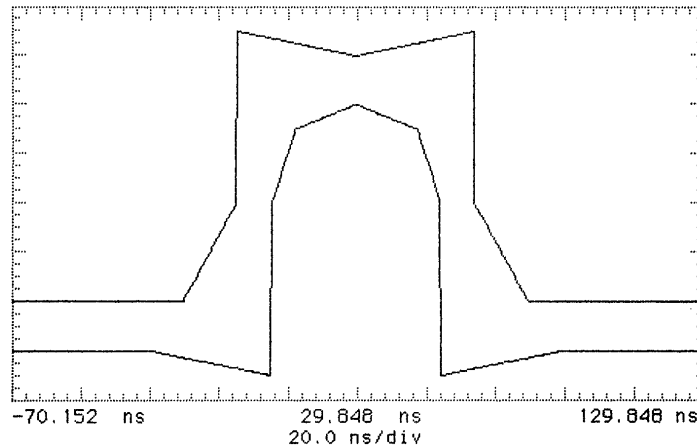
**Figure 3-17****8 Mb/s Pulse Mask**

46. Repeat steps 42 to 45 with the Oscilloscope Channel 1 connected to **SIGNAL OUT 3** and **SIGNAL OUT 4** in turn.

47. Press **AUTOSCALE** on the oscilloscope to display the full waveform and use the following sequence to display the isolated negative pulse:

Select **TRIG** menu.

Set trigger level to middle of negative pulse.

Set Trigger to **PATTERN**.

Set Sequence to **H X X**.

48. Use the oscilloscope **STORE INVERT** function to display an inverted pulse mask on the oscilloscope.

49. Adjust the oscilloscope timebase, delay and vertical sensitivity controls to verify that the pulse meets the mask as shown in Figure 3-17. Use the displayed settings as a guide.

50. Measure the peak pulse amplitude at mid-pulse-width using the Oscilloscope and verify that this is between 2.133V and 2.607V.

Performance Tests

Multiple PDH Transmitter Outputs (Options UHC, [US6])

51. Repeat steps 49 and 50 with the Oscilloscope Channel 1 connected to **SIGNAL OUT 2** and **SIGNAL OUT 3** in turn.

8.448 Mb/s Additional Output Delay

52. Connect the **PDH SIGNAL OUT 1** port to the Oscilloscope Channel 1. Set the Oscilloscope termination to $1M\Omega$

53. Connect the **PDH SIGNAL OUT 2** port to the Oscilloscope Channel 2. Set the Oscilloscope termination to $1M\Omega$

54. Check that the pulse on Channel 2 is 4 bits delayed with respect to the pulse on Channel 1.

55. Disconnect the **SIGNAL OUT 2** port from the oscilloscope and connect the **SIGNAL OUT 3** port to the oscilloscope Channel 2.

56. Check that the pulse on Channel 2 is 8 bits delayed with respect to the pulse on Channel 1.

57. Disconnect the **SIGNAL OUT 3** port from the oscilloscope and connect the **SIGNAL OUT 4** port to the oscilloscope Channel 2.

58. Check that the pulse on Channel 2 is 12 bits delayed with respect to the pulse on Channel 1.

59. Ensure that the ratio of +ve and -ve pulse amplitudes is between 0.95 and 1.05.

60. Ensure that the ratio of +ve and -ve pulse widths is between 0.95 and 1.05.

34.368 Mb/s Output Pulse

61. Connect the **PDH SIGNAL OUT 2** port to the Oscilloscope Channel 1.

62. Press **TRANSMIT** and set up the display as shown opposite.

63. Press **AUTOSCALE** on the oscilloscope.

64. Adjust the Oscilloscope Timebase and Delay to position the positive peak pulse amplitude at mid-pulse-width point in the centre of the screen.

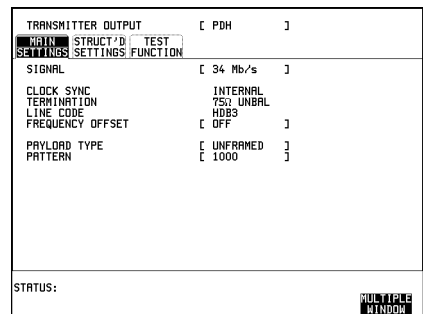

65. Measure the peak pulse amplitude at mid-pulse-width using the Oscilloscope and verify that this is between 0.900V and 1.100V.

Performance Tests

Multiple PDH Transmitter Outputs (Options UHC, [US6])

66. Select the 34Mb/s G703 Mask on the oscilloscope and store it on the Display.

67. Press SHIFT **AUTOSCALE** on the oscilloscope to automatically align the pulse to the mask. Verify that the pulse falls within the mask as shown in Figure 3-18.

NOTE

If your oscilloscope does not have the Mask feature, obtain a printout of the displayed pulse. Place the mask shown in Figure 3-18 over the pulse and ensure that the pulse falls within the mask (a transparent copy of the mask should be used).

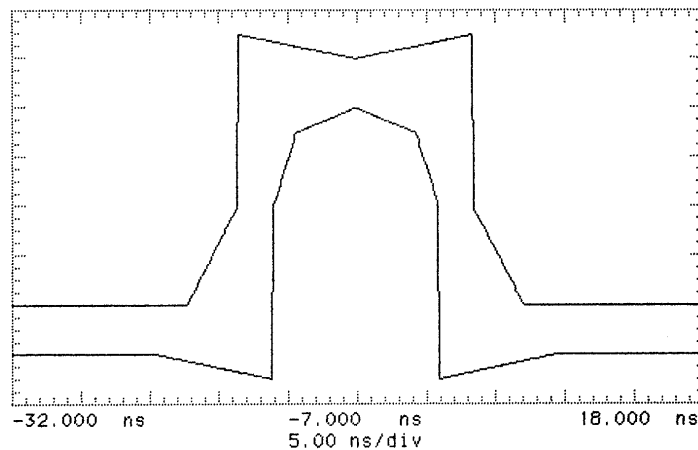

Figure 3-18

34 Mb/s Pulse Mask

68. Repeat steps 64 to 67 with the Oscilloscope Channel 1 connected to **SIGNAL OUT 3** and **SIGNAL OUT 4** in turn.

69. Press **AUTOSCALE** on the oscilloscope to display the full waveform and use the following sequence to display the isolated negative pulse:

Select **TRIG** menu.

Set trigger level to middle of negative pulse.

Set Trigger to **PATTERN**.

Set Sequence to **H X X**.

70. Use the oscilloscope **STORE INVERT** function to display an inverted pulse mask on the oscilloscope.

Performance Tests

Multiple PDH Transmitter Outputs (Options UHC, [US6])

71. Adjust the oscilloscope timebase, delay and vertical sensitivity controls to verify that the pulse meets the mask as shown in Figure 3-18. Use the displayed settings as a guide.

72. Measure the peak pulse amplitude at mid-pulse-width using the Oscilloscope and verify that this is between 0.900V and 1.100V.

73. Repeat steps 71 and 72 with the Oscilloscope Channel 1 connected to **SIGNAL OUT 2** and **SIGNAL OUT 3** in turn.

34.368 Mb/s Additional Outputs Delay

74. Connect the **PDH SIGNAL OUT 1** port to the Oscilloscope Channel 1. Set the Oscilloscope termination to $1M\Omega$

75. Connect the **PDH SIGNAL OUT 2** port to the Oscilloscope Channel 2. Set the Oscilloscope termination to $1M\Omega$

76. Set the Transmitter Output PATTERN to USER WORD 111111110001000 and check that the pulse on Channel 2 is 4 bits delayed with respect to the pulse on Channel 1.

77. Disconnect the **SIGNAL OUT 2** port from the oscilloscope and connect the **SIGNAL OUT 3** port to the oscilloscope Channel 2.

78. Check that the pulse on Channel 2 is 8 bits delayed with respect to the pulse on Channel 1.

79. Disconnect the **SIGNAL OUT 3** port from the oscilloscope and connect the **SIGNAL OUT 4** port to the oscilloscope Channel 2.

80. Check that the pulse on Channel 2 is 12 bits delayed with respect to the pulse on Channel 1.

81. Ensure that the ratio of +ve and -ve pulse amplitudes is between 0.95 and 1.05.

82. Ensure that the ratio of +ve and -ve pulse widths is between 0.95 and 1.05.

139.264 Mb/s Output Pulse

83. Connect the **PDH SIGNAL OUT 2** port to the Oscilloscope Channel 1.

Performance Tests

Multiple PDH Transmitter Outputs (Options UHC, [US6])

84. Press **TRANSMIT** and set up the display as shown opposite.

85. Press **AUTOSCALE** on the oscilloscope.

86. Select the BIN1 140 Mb G.703 mask on the oscilloscope and store it on the display.

87. Adjust the Oscilloscope Timebase and Delay to position the positive peak pulse amplitude at mid-pulse-width point in the centre of the screen.

88. Measure the peak pulse amplitude at mid-pulse-width using the Oscilloscope and verify that this is between 0.900V and 1.100V.

89. Press SHIFT **AUTOSCALE** on the oscilloscope to automatically align the pulse to the mask. Verify that the pulse falls within the mask as shown in Figure 3-20.

90. Repeat steps 87 to 89 with the Oscilloscope Channel 1 connected to **SIGNAL OUT 3** and **SIGNAL OUT 4** in turn.

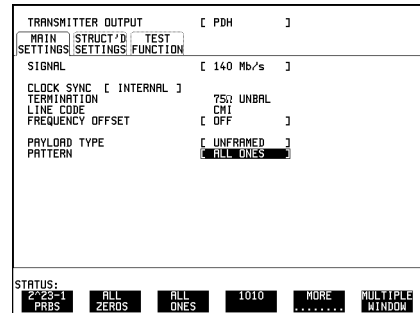

NOTE

If your oscilloscope does not have the Mask feature, obtain a printout of the displayed pulse. Place the mask shown in Figure 3-19 over the pulse and ensure that the pulse falls within the mask (a transparent copy of the mask should be used).

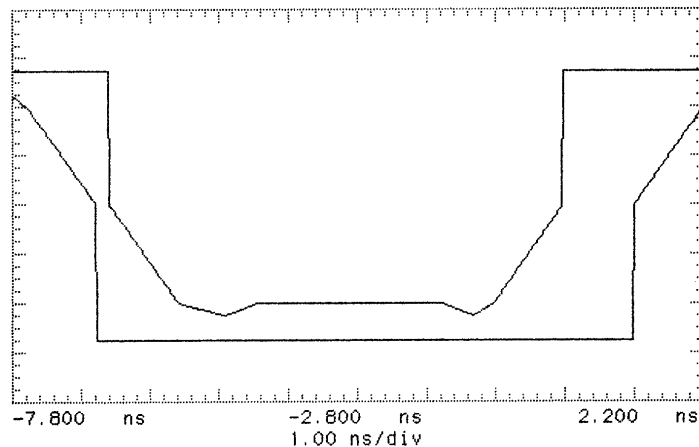

Figure 3-19

140 Mb/s Pulse Mask All 1's

Performance Tests

Multiple PDH Transmitter Outputs (Options UHC, [US6])

91. Select PATTERN [ALL ZEROS] on the **TRANSMIT** display.
92. Select the BIN 0 140Mb/s G703 Mask on the oscilloscope and store it on the Display.
93. Adjust the Oscilloscope Timebase and Delay to position the positive peak pulse amplitude at mid-pulse-width point in the centre of the screen.
94. Measure the peak pulse amplitude at mid-pulse-width using the Oscilloscope and verify that this is between 0.900V and 1.100V.
95. Press SHIFT **AUTOSCALE** on the oscilloscope to automatically align the pulse to the mask. Verify that the pulse falls within the mask as shown in Figure 3-20.

NOTE

If your oscilloscope does not have the Mask feature, obtain a printout of the displayed pulse. Place the mask shown in Figure 3-20 over the pulse and ensure that the pulse falls within the mask (a transparent copy of the mask should be used).

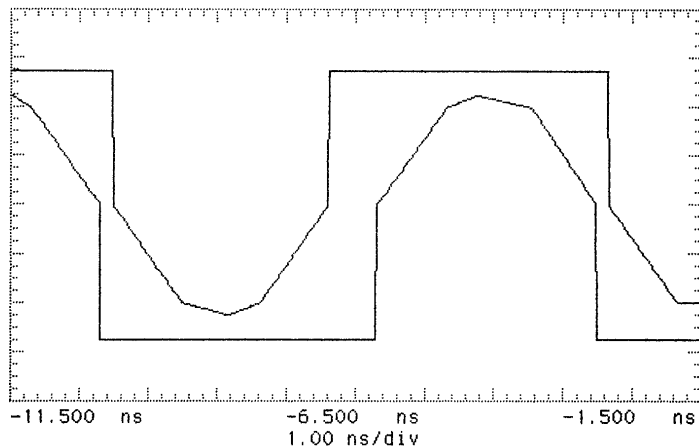

Figure 3-20

140 Mb/s Pulse Mask All 0's

96. Repeat steps 93 to 95 with the Oscilloscope Channel 1 connected to **SIGNAL OUT 2** and **SIGNAL OUT 3** in turn.

Performance Tests

Multiple PDH Transmitter Outputs (Options UHC, [US6])

Additional Outputs Delay at 139.264 Mb/s

97. Connect the **PDH SIGNAL OUT 1** port to the Oscilloscope Channel 1. Set the Oscilloscope termination to $1M\Omega$.
98. Connect the **PDH SIGNAL OUT 2** port to the Oscilloscope Channel 2. Set the Oscilloscope termination to $1M\Omega$.
99. Set the Transmitter Output PATTERN to 1000 and check that the pulse on Channel 1 is in phase with the pulse on Channel 2.
100. Disconnect the **SIGNAL OUT 2** port from the oscilloscope and connect the **SIGNAL OUT 3** port to the oscilloscope Channel 2.
101. Check that the pulse on Channel 1 is in phase with the pulse on Channel 2.
102. Disconnect the **SIGNAL OUT 3** port from the oscilloscope and connect the **SIGNAL OUT 4** port to the oscilloscope Channel 2.
103. Check that the pulse on Channel 1 is in phase with the pulse on Channel 2.
104. Disconnect the test equipment.

PDH Frame Analysis (Options UKK, [USB])

Specifications

140 Mb/s	Frame Loss - 4 consecutive incorrect FAS words. Frame Gain - 3 consecutive correct FAS words (1111010000).
34 Mb/s	Frame Loss - 4 consecutive incorrect FAS words. Frame Gain - 3 consecutive correct FAS words (1111010000).
8 Mb/s	Frame Loss - 4 consecutive incorrect FAS words. Frame Gain - 3 consecutive correct FAS words (1111010000).
2 Mb/s	Frame Loss - 3 consecutive incorrect FAS words or NFAS words. Frame Gain - 1 correct sequence of FAS - NFAS - FAS words.
2 Mb/s CRC	MultiFrame Loss - 3 out of 4 MultiFrame sequences in error MultiFrame Gain - 2 out of 4 MultiFrame sequences are correct.
2 Mb/s CAS	MultiFrame Loss - 2 consecutive MultiFrame patterns in error. MultiFrame Gain - 1 correct MultiFrame pattern is correct.

Equipment Required

Frame Generator : HP 37729A

Description

An HP 37729A Frame Generator is used to generate the appropriate Frame Alignment Signals (FAS) which are used to test the HP 37717C In-Service Analysis at all bit rates with this capability.

NOTE

If the HP 37729A is not available, a HP 37714/17A with Option UKJ, [USA] may be substituted.

Performance Tests
PDH Frame Analysis (Options UKK, [USB])

Procedure

1. Recall the HP 37717C DEFAULT SETTINGS as shown on 3-2.

Option UKK, [USB] Unstructured PDH

2. Setup the **RECEIVE** Display as shown opposite.

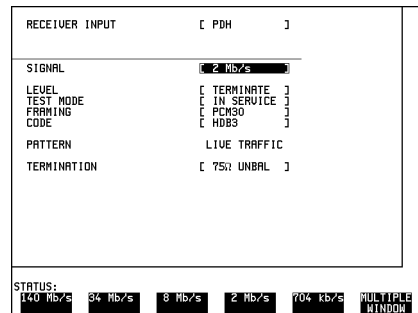

3. Setup the **RESULTS** display as shown opposite.

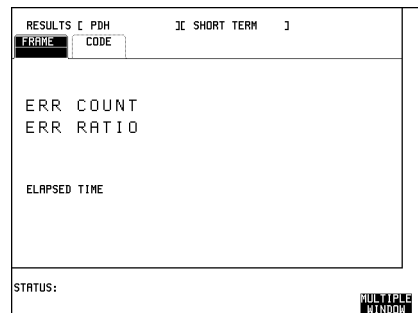

Option UKJ, [USA] Structured PDH

2. Setup the **RECEIVE** Display as shown opposite.

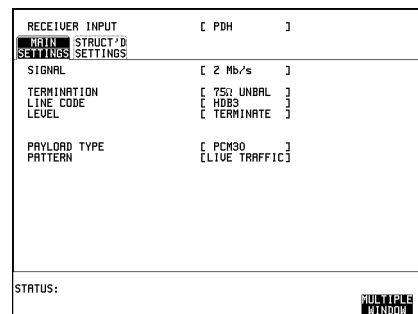

Performance Tests

PDH Frame Analysis (Options UKK, [USB])

3. Setup the **RESULTS** display as shown opposite.

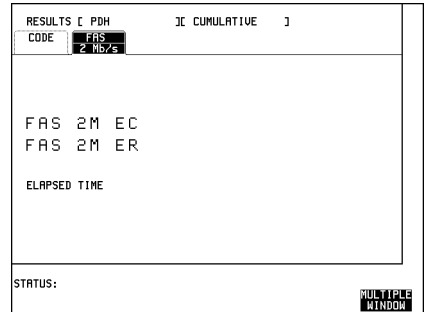

2 Mb/s Frame Analysis

1. Set the HP 37729A Frame Generator parameters as follows:

OUTPUT; FREQ [2]; CODE [HDB3]

Press the **MENU** key to select the MENU display.

Use **↑** and **↓** to select [ALIGNMENT].

Press **ENTER** to select the ALIGNMENT parameters.

Use **PAGE UP** and **PAGE DOWN** to select ALIGNMENT [2M].

FAS [10011011]

NFAS [01011111]

Press until all the 2048 Kbit/s Led's are OFF.

2. Connect the Frame Generator AMI/HDB3 output to the HP 37717C 75Ω SIGNAL IN port.
3. Press **RUN/STOP** on the HP 37717C to start the measurement.
4. Check that all PDH Alarm Led's are OFF. Error Count and Error Ratio should be 0.

CAS Multiframe

5. Press the Frame Generator 2048 Kbit/s **SELECT** key until the CAS MFL Led is flashing.
6. Press the Frame Generator 2048 Kbit/s **ON/OFF** key and check that the HP 37717C PDH Multiframe Loss Alarm Led is ON.

Performance Tests

PDH Frame Analysis (Options UKK, [USB])

7. Press the Frame Generator 2048 Kbit/s **ON/OFF** key and ensure all HP 37717C Alarm Led's are OFF.

8. Press **RUN/STOP** on the HP 37717C to stop the measurement.

CRC Multiframe

9. Select FRAMING [PCM30CRC] on the HP 37717C **RECEIVE** display.

10. Select ERROR SOURCE [CRC] on the HP 37717C **RESULTS** display.

11. Press **RUN/STOP** on the HP 37717C to start the measurement.

12. Use the Frame Generator **SELECT** and **ON/OFF** keys to select and enable CRC MFL.

13. Check that the HP 37717C displays a CRC errors count and that the Errors Led is ON.

14. Check that after several seconds, the HP 37717C CRC error count stops and the PDH Frame Loss and Multiframe Loss Alarm Led's are ON.

15. Press the Frame Generator 2048 Kbit/s **ON/OFF** key and check that the PDH Frame Loss and Multiframe Loss Alarm Led's are now OFF.

Error Detection

16. Use the Frame Generator 2048 Kbit/s **SELECT** and **ON/OFF** keys to select and enable BIT ERROR 2Mb/s.

17. Check that the HP 37717C counts FRAME (FAS), CRC and REBE errors. A minimum of 1 REBE error should occur in a 1 minute period. The CODE Error Count should be 0.

Alarm Detection

18. Use the Frame Generator 2048 Kbit/s **SELECT** and **ON/OFF** keys to select and enable DF (Remote Alarm) and check that the HP 37717C Remote Alarm Led is ON.

19. Press the Frame Generator 2048 Kbit/s **ON/OFF** key.

20. Use the Frame Generator 2048 Kbit/s **SELECT** and **ON/OFF** keys to select and enable DMF (Remote Multiframe Alarm) and check that the HP 37717C Remote Multiframe Alarm Led is ON.

21. Press the Frame Generator 2048 Kbit/s **ON/OFF** key.

22. Press **RUN/STOP** on the HP 37717C once to stop the measurement.

Performance Tests

PDH Frame Analysis (Options UKK, [USB])

8 Mb/s Frame Analysis

1. Select SIGNAL [8 Mb/s] on the HP 37717C **RECEIVE** display then return to **RESULTS** Display.
2. Set the HP 37729A Frame Generator parameters as follows:
OUTPUT: FREQ [8]; CODE [HDB3]
ALIGNMENT [8M]
SB [00]
FAS [1111010000]
Press the **SELECT** key until all 8448 Kbit/s ERROR and AIS Led's are OFF.
3. Press **RUN/STOP** on the HP 37717C to start a measurement and check that all Alarm Led's are OFF on the HP 37717C. The Error Count and Error Ratio should be 0.

Error Detection

4. Use the Frame Generator 8448 Kbit/s **SELECT** and **ON/OFF** keys to select and enable BIT ERROR.
5. Check that HP 37717C Errors and Remote alarm Led's are ON (may be flashing).
6. Check that the HP 37717C counts Frame (FAS) Errors. The Code Error count should be 0.
7. Press the Frame Generator 8448 Kbit/s **ON/OFF** key and check that the FRAME (FAS) Error Count is 0 and all Alarm Led's are now OFF.

Alarm Detection

8. Set the Frame Generator SB parameter to [10].
9. Check that the HP 37717C Remote Alarm Led is ON. Error Count and Error Ratio should be 0.
10. Reset the Frame Generator SB parameter to [00].

FAS Error and AIS

11. Use the Frame Generator 8448 Kbit/s **SELECT** and **ON/OFF** keys to select and enable FAS ERROR.
12. Check that the HP 37717C Frame Loss alarm Led is ON.
13. Press the Frame Generator 8448 Kbit/s **ON/OFF** key and check that the FRAME (FAS) Error Count is 0 and all Alarm Led's are now OFF.

Performance Tests

PDH Frame Analysis (Options UKK, [USB])

14. Use the Frame Generator 8448 Kbit/s **SELECT** and **ON/OFF** keys to select and enable AIS OUT.
15. Check that the HP 37717C Frame Loss and AIS alarm Led's are ON.
16. Press the Frame Generator 8448 Kbit/s **ON/OFF** key and check that the FRAME (FAS) Error Count is 0 and all Alarm Led's are now OFF.
17. Press **RUN/STOP** on the HP 37717C once to stop the measurement.

34 Mb/s Frame Analysis

1. Select SIGNAL [34 Mb/s] on the HP 37717C **RECEIVE** display then return to **RESULTS** Display.
2. Set the HP 37729A Frame Generator parameters as follows:
OUTPUT: FREQ [34]; CODE [HDB3]
ALIGNMENT [34M]
SB [00]
FAS [1111010000]
Press the 34368 Kbit/s **SELECT** key until all 34368 Kbit/s ERROR and AIS Led's are OFF.
3. Press **RUN/STOP** on the HP 37717C to start a measurement and check that all HP 37717C Alarm Led's are OFF. The Error Count and Error Ratio should be 0.

Error Detection

4. Press the 34368 Kbit/s **SELECT** key until all 34368 Kbit/s ERROR and AIS Led's are OFF.
5. Use the Frame Generator 34368 Kbit/s **SELECT** and **ON/OFF** keys to select and enable BIT ERROR.
6. Check that Errors and Remote alarm Led's are ON.
7. Check that the HP 37717C counts Frame (FAS) Errors. The Code Error count should be 0.
8. Press the Frame Generator 34368 Kbit/s **ON/OFF** key and check that the FRAME (FAS) Error Count is 0 and all Alarm Led's are now OFF.

Alarm Detection

9. Set the Frame Generator SB parameter to [10].

Performance Tests

PDH Frame Analysis (Options UKK, [USB])

10. Check that the HP 37717C Remote Alarm Led is ON. Error Count and Error Ratio should be 0.

11. Reset the Frame Generator SB parameter to [00].

FAS Error and AIS

12. Use the Frame Generator 34368 Kbit/s **SELECT** and **ON/OFF** keys to select and enable FAS ERROR.

13. Check that the HP 37717C Frame Loss alarm Led is ON.

14. Press the Frame Generator 34368 Kbit/s **ON/OFF** key and check that the FRAME (FAS) Error Count is 0 and all Alarm Led's are now OFF.

15. Use the Frame Generator 34368 Kbit/s **SELECT** and **ON/OFF** keys to select and enable AIS OUT.

16. Check that the HP 37717C Frame Loss and AIS alarm Led's are ON.

17. Press the Frame Generator 34368 Kbit/s **ON/OFF** key and check that the FRAME (FAS) Error Count is 0 and all Alarm Led's are now OFF.

18. Press **RUN/STOP** on the HP 37717C once to stop the measurement.

140 Mb/s Frame Analysis

1. Select SIGNAL: [140 Mb/s] on the HP 37717C **RECEIVE** display then return to **RESULTS** Display.

2. Set the HP 37729A Frame Generator parameters as follows:

OUTPUT: FREQ [139]; CODE [CMI]

ALIGNMENT [140M]

SB [0000]

FAS [111110100000]

Press the 139264 Kbit/s **SELECT** key until all the 139264 Kbit/s ERROR and AIS Led's are OFF.

3. Connect the Frame Generator CMI/NRZ output to the HP 37717C 75Ω SIGNAL IN port.

4. Press **RUN/STOP** on the HP 37717C to start a measurement and ensure all Alarm Led's are OFF. Check that the HP 37717C Error Count and Error Ratio is 0.

Performance Tests

PDH Frame Analysis (Options UKK, [USB])

Error Detection

5. Use the Frame Generator 139264 Kbit/s **SELECT** and **ON/OFF** keys to select and enable BIT ERROR.
6. Check that Errors and Remote alarm Led's are ON.
7. Check that the HP 37717C counts Frame (FAS) Errors. The Code Error count should be 0.
8. Press the Frame Generator **ON/OFF** key and check that the FRAME (FAS) and CODE error count is 0 and the Alarm Led's are OFF.

Alarm Detection

9. Set the Frame Generator SB parameter to [1000].
10. Check that the HP 37717C Remote Alarm Led is ON. Check that the Error Count and Error Ratio is 0.
11. Reset the Frame Generator SB parameter to [0000].

FAS Error and AIS

12. Use the Frame Generator 139264 Kbit/s **SELECT** and **ON/OFF** keys to select and enable FAS ERROR.
13. Check that the HP 37717C Frame Loss alarm Led is ON.
14. Press the Frame Generator 139264 Kbit/s **ON/OFF** key and check that the FRAME (FAS) Error Count is 0 and all Alarm Led's are now OFF.
15. Use the Frame Generator 139264 Kbit/s **SELECT** and **ON/OFF** keys to select and enable AIS OUT.
16. Check that the HP 37717C Frame Loss and AIS alarm Led's are ON.
17. Press the Frame Generator 139264 Kbit/s **ON/OFF** key and check that the FRAME (FAS) Error Count is 0 and all Alarm Led's are now OFF.
18. Press **RUN/STOP** on the HP 37717C once to stop the measurement.
19. Disconnect the test equipment.

Performance Tests

PDH Receiver Equalization (Options UKK, [USB], UKJ, [USA], UKL, [USC], UKN, [USE])

PDH Receiver Equalization (Options UKK, [USB], UKJ, [USA], UKL, [USC], UKN, [USE])

Specifications

Bit Rate	Option	Equalization at 1/2 Bit Rate
704 kb/s	UKK, [USB]	6dB
2.048 Mb/s	UKK, [USB], UKJ, [USA], UKL, [USC], UKN, [USE]	6dB
8.448 Mb/s	UKK, [USB], UKJ, [USA], UKL, [USC], UKN, [USE]	6dB
34.368 Mb/s	UKK, [USB], UKJ, [USA], UKL, [USC], UKN, [USE]	12dB
139.264 Mb/s	UKK, [USB], UKJ, [USA], UKL, [USC], UKN, [USE]	12dB

Description

The PDH receiver equalization is checked using a Synthesizer set for a sinewave at half the data rate. This sinewave corresponds to a ternary all ones signal and the HP 37717C receiver should sync up with no errors if PATTERN [ALL ONES] is selected. The amplitude of the synthesizer signal is set to the specified maximum loss for each bit rate. At that amplitude no errors should result.

Equipment Required

Synthesizer : HP 3335A option 001

Oscilloscope : HP 54503A

Performance Tests

PDH Receiver Equalization (Options UKK, [USB], UKJ, [USA], UKL, [USC], UKN, [USE])

Procedure

1. Recall the HP 37717C DEFAULT SETTINGS as shown on 3-2.
2. Connect up the equipment as shown in Figure 3-21.
3. Set the oscilloscope: TERMINATION - 1 M Ω PROBE - 1:1

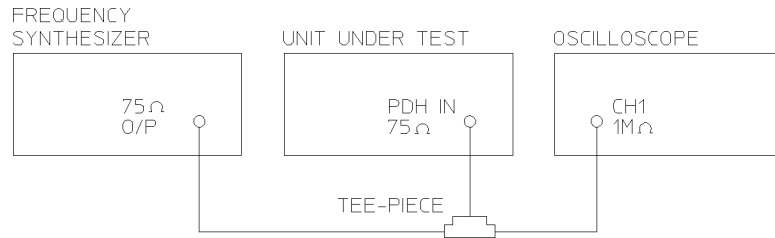

Figure 3-21

PDH Receiver Equalization Test Setup

704 kb/s

NOTE

Steps 4 to 8 are only valid if Option UKK, [USB] is fitted.

4. Press **RECEIVE** and set up the display as shown opposite.

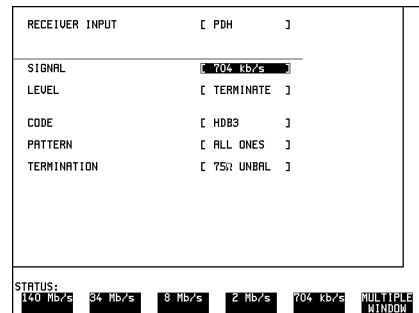

5. Select **RESULTS** **TIMING** **CONTROL** TEST TIMING [SINGLE] [5 SECS]

Performance Tests

PDH Receiver Equalization (Options UKK, [USB], UKJ, [USA], UKL, [USC], UKN, [USE])

6. Press **RESULTS** and set up the display as shown opposite.

7. Set the Synthesizer to: FREQUENCY - 352 KHz sinewave AMPLITUDE - 2.37 V pk-pk (6dB down) as measured on the oscilloscope.

8. Press **RUN/STOP** and verify that no errors are displayed at the end of the test period (5 seconds).

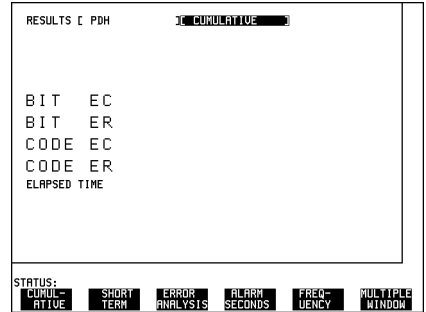

2.048 Mb/s

9. Press **RECEIVE** and set up the display as shown opposite.

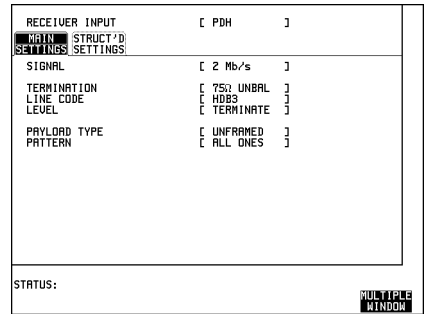

10. Select **RESULTS** **TIMING** **CONTROL** TEST TIMING [SINGLE] [5 SECS]

11. Press **RESULTS** and set up the display as shown opposite.

12. Set the Synthesizer to: FREQUENCY, 1024 KHz sinewave AMPLITUDE, 2.37 V pk-pk (6dB down) as measured on the oscilloscope.

13. Press **RUN/STOP** and verify that no errors are displayed on the **RESULTS** display at the end of the test period (5 seconds).

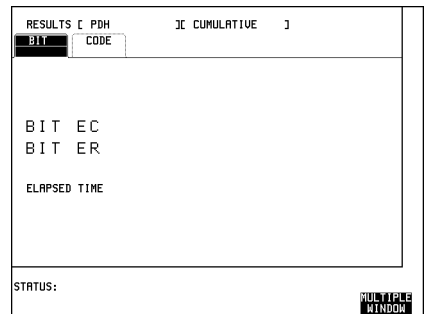

Performance Tests

PDH Receiver Equalization (Options UKK, [USB], UKJ, [USA], UKL, [USC], UKN, [USE])

8.448 Mb/s

14. Select SIGNAL [8 Mb/s] on the **RECEIVE** display.
15. Set the Synthesizer to: FREQUENCY - 4224 KHz sinewave AMPLITUDE - 2.37 V pk-pk (6dB down) as measured on the oscilloscope.
16. Press **RUN/STOP** and verify that no errors are displayed on the **RESULTS** display at the end of the test period (5 seconds).

34.368 Mb/s

17. Select SIGNAL [34 Mb/s] on the **RECEIVE** display.
18. Set the Synthesizer to: FREQUENCY - 17184 KHz sinewave AMPLITUDE - 0.5 V pk-pk (12dB down) as measured on the oscilloscope.
19. Press **RUN/STOP** and verify that no errors are displayed on the **RESULTS** display at the end of the test period (5 seconds).

139.264 Mb/s

20. Select SIGNAL [140 Mb/s] on the **RECEIVE** display.
21. Set the Synthesizer to: FREQUENCY - 69632 KHz sinewave AMPLITUDE - 0.25 V pk-pk (12dB down) as measured on the oscilloscope.
22. Press **RUN/STOP** and verify that no errors are displayed on the **RESULTS** display at the end of the test period (5 seconds).

PDH Receiver Monitor Levels (Options UKK, [USB])

Specification

Bit Rate	Nominal Loss
704 kb/s	26 to 30dB
2.048 Mb/s	26 to 30dB
8.448 Mb/s	26 to 30dB
34.368 Mb/s	26dB
139.264 Mb/s	26dB

Description

The PDH receiver Monitor levels are checked by attenuating the synthesizer output level by an amount equivalent to the extra gain provided by the Monitor Amplifier. The synthesizer is set to generate a sinewave at half the bit rate which corresponds to a ternary all ones signal. The receiver should sync up with no errors if PATTERN [ALL ONES] is selected.

Equipment Required

Synthesizer : HP 3335A option 001

Oscilloscope : HP 54503A

Procedure

1. Recall the HP 37717C DEFAULT SETTINGS as shown on 3-2.
2. Connect up the equipment as shown in Figure 3-22.
3. Set the oscilloscope to: TERMINATION - 1 M Ω PROBE - 1:1
4. Select **RESULTS** **TIMING** **CONTROL** TEST TIMING [SINGLE] [5 SECS]

Performance Tests

PDH Receiver Monitor Levels (Options UKK, [USB])

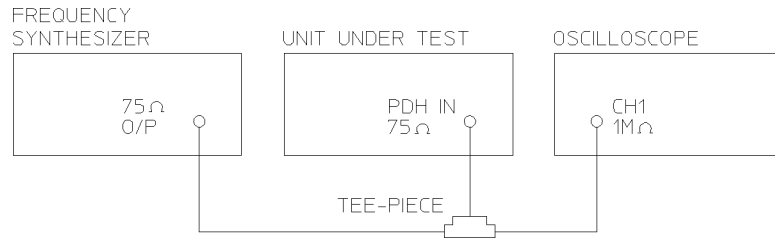

Figure 3-22

PDH Receiver Monitor Levels Test Setup

704 kb/s

5. Press **RECEIVE** and set up the display as shown opposite.

Press **RUN/STOP** until the Monitor led is lit.

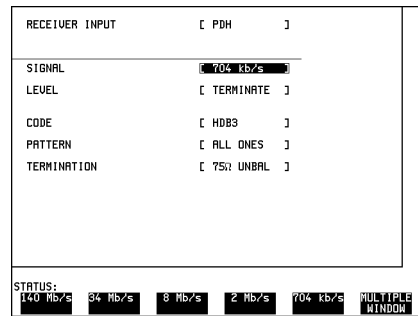

6. Press **RESULTS** and set up the display as shown below.

7. Set the Synthesizer to: FREQUENCY - 352 KHz sinewave AMPLITUDE - 150 mV pk-pk (30dB down) as measured on the oscilloscope.

8. Press **RUN/STOP** and verify that no errors are displayed at the end of the test period (5 seconds).

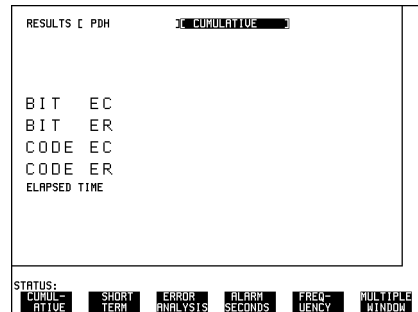

Performance Tests

PDH Receiver Monitor Levels (Options UKK, [USB])

2.048 Mb/s

9. Select SIGNAL [2 Mb/s] on the **RECEIVE** display.
10. Set the Synthesizer to: FREQUENCY - 1024 KHz sinewave AMPLITUDE - 150 mV pk-pk (30dB down) as measured on the oscilloscope.
11. Press **RUN/STOP** and verify that no errors are displayed at the end of the test period (5 seconds).

8.448 Mb/s

12. Select SIGNAL [8 Mb/s] on the **RECEIVE** display.
13. Set the Synthesizer to: FREQUENCY - 4224 KHz sinewave AMPLITUDE - 150 mV pk-pk (30dB down) as measured on the oscilloscope.
14. Press **RUN/STOP** and verify that no errors are displayed at the end of the test period (5 seconds).

34.368 Mb/s

15. Select SIGNAL [34 Mb/s] on the **RECEIVE** display.
16. Set the Synthesizer to: FREQUENCY - 17184 KHz sinewave AMPLITUDE - 100 mV pk-pk (26dB down) as measured on the oscilloscope.
17. Press **RUN/STOP** and verify that no errors are displayed at the end of the test period (5 seconds).

139.264 Mb/s

18. Select SIGNAL [140 Mb/s] on the **RECEIVE** display.
19. Set the Synthesizer to: FREQUENCY - 69632 KHz sinewave AMPLITUDE - 50 mV pk-pk (26dB down) as measured on the oscilloscope.
20. Press **RUN/STOP** and verify that no errors are displayed at the end of the test period (5 seconds).

SPDH Receiver Monitor Levels (Options UKJ, [USA], UKL, [USC], UKN, [USE])**SPDH Receiver Monitor Levels (Options UKJ, [USA], UKL, [USC], UKN, [USE])****NOTE**

An SPDH Tx Module must be fitted for this test - see Appendix B.

Specifications

Bit Rate	Nominal Loss	Equalization at 1/2 Bit Rate
2.048 Mb/s	20, 26, 30dB	3dB
8.448 Mb/s	20, 26, 30dB	3dB
34.368 Mb/s	20, 26dB	6dB
139.264 Mb/s	20, 26dB	6dB

Description

The signal from the HP 37717C PDH Transmitter is applied to the PDH Receiver after attenuating by an amount equal to the selected Receiver Flat Loss plus the specified Cable Loss. The Flat Loss is obtained by inserting a number of 50Ω fixed attenuators in series with a $75/50\Omega$ Matching Pad at one end and a $50/75\Omega$ Matching Pad at the other end. The loss of the two Matching Pads is included in the overall attenuation equation. The Cable Loss is supplied by inserting the correct Cable Simulators for each bit rate in the attenuation path.

Equipment Required**Table 3- 2**

Cable Simulator #1	: 80 metres (262 ft) of 75Ω coaxial cable (8120-0049)
Cable Simulator #2	: 60 metres (197 ft) of 75Ω coaxial cable (8120-0049)
Cable Simulator #3	: 70 metres (230 ft) of 75Ω coaxial cable (8120-0049)
Cable Simulator #4	: 30 metres (98 ft) of 75Ω coaxial cable (8120-0049)

Table 3- 2 continued

Fixed Attenuator (Qty 2)	: HP 8491A Option 006 (6dB; 50Ω)
Fixed Attenuator (Qty 2)	: HP 8491A Option 003 (3dB; 50Ω)
Matching Pad 75/50Ω (7.6dB loss)	: HP 11852B
Matching Pad 50/75Ω (4.2dB loss)	: HP 11852B

Procedure

1. Recall the HP 37717C DEFAULT SETTINGS as shown on 3-2.
2. Connect the equipment as shown in Figure 3-23.

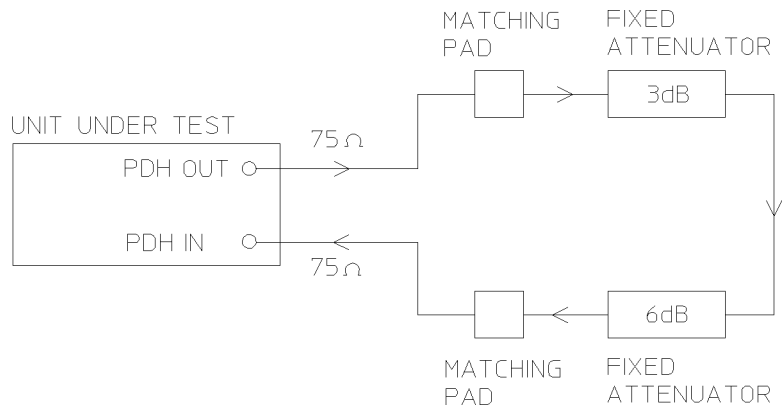

Figure 3-23 SPDH Receiver Monitor Input

Performance Tests

SPDH Receiver Monitor Levels (Options UKJ, [USA], UKL, [USC], UKN, [USE])

2.048 Mb/s

3. Press **TRANSMIT** and set up the **MAIN SETTINGS** display as shown opposite.

TRANSMITTER OUTPUT	[PDH]
MAIN STRUCT'D TEST	
SETTINGS SETTINGS: FUNCTION	
SIGNAL	[2 Mb/s]
CLOCK SYNC	[INTERNAL]
TERMINATION	[75Ω UNBAL]
LINE CODE	[HDB3]
FREQUENCY OFFSET	[OFF]
PAYLOAD TYPE	[UNFRAMED]
PATTERN	[2 ⁿ 15-1 PRBS]
PRBS POLARITY	[INV] ITU
STATUS:	
	MULTIPLE WINDOW

4. Press **RECEIVE** and set up the **MAIN SETTINGS** display as shown opposite.

5. Press **RESULTS TROUBLE SCAN**.

Press **RUN/STOP** to start the measurement.

6. Ensure that NO TROUBLE is displayed on the **RESULTS** display

7. After 30 seconds. Press **RUN/STOP** to stop the measurement.

RECEIVER INPUT	[PDH]
MAIN STRUCT'D	
SETTINGS SETTINGS	
SIGNAL	[2 Mb/s]
TERMINATION	[75Ω UNBAL]
LINE CODE	[HDB3]
LEVEL	[MONITOR]
EQUALIZER [ON] GAIN	[20 dB]
PAYLOAD TYPE	[UNFRAMED]
PATTERN	[2 ⁿ 15-1 PRBS]
PRBS POLARITY	[INV] ITU
STATUS:	
2 ⁿ 9-1 PRBS	2 ⁿ 11-1 PRBS
2 ⁿ 15-1 PRBS	2 ⁿ 20-1 PRBS
MORE	MULTIPLE WINDOW

8. Press **RECEIVE** and select EQUALIZATION [ON] GAIN [20 dB].

9. Connect Cable Simulator #1 between the PDH OUT Port and the Matching Pad.

10. Press **RESULTS TROUBLE SCAN**. Press **RUN/STOP** to start the measurement.

11. Ensure that NO TROUBLE is displayed on the **RESULTS** display after 30 seconds. Press **RUN/STOP** to stop the measurement.

12. Connect the second 6dB Fixed Attenuator in the signal path to give a total path attenuation of 26.8dB (7.6+3+6+6+4.2).

13. Press **RECEIVE** and set MONITOR LEVEL [26dB].

14. Press **RESULTS**; **TROUBLE SCAN**. Press **RUN/STOP** to start the measurement.

Performance Tests

SPDH Receiver Monitor Levels (Options UKJ, [USA], UKL, [USC], UKN, [USE])

15. Ensure that NO TROUBLE is displayed on the **RESULTS** display after 30 seconds. Press **RUN/STOP** to stop the measurement.
16. Remove Cable Simulator #1 from the signal path.
17. Press **RECEIVE** and select EQUALIZATION [OFF].
18. Press **RESULTS**; **TROUBLE SCAN** . Press **RUN/STOP** to start the measurement.
19. Ensure that NO TROUBLE is displayed on the **RESULTS** display after 30 seconds. Press **RUN/STOP** to stop the measurement.
20. Connect the second 3dB Fixed Attenuator in the signal path to give a total path attenuation of 29.8dB (7.6+3+3+6+6+4.2).
21. Press **RECEIVE** and set MONITOR LEVEL [30dB].
22. Press **RESULTS** **TROUBLE SCAN** . Press **RUN/STOP** to start the measurement.
23. Ensure that NO TROUBLE is displayed on the **RESULTS** display after 30 seconds. Press **RUN/STOP** to stop the measurement.
24. Press **RECEIVE** and select EQUALIZATION [ON].
25. Connect Cable Simulator #1 between the PDH OUT Port and the Matching Pad.
26. Press **RESULTS** **TROUBLE SCAN** . Press **RUN/STOP** to start the measurement.
27. Ensure that NO TROUBLE is displayed on the **RESULTS** display after 30 seconds. Press **RUN/STOP** to stop the measurement.

8.448 Mb/s

28. Repeat steps 1 to 26 (20dB, 26dB and 30dB tests) with the HP 37717C **TRANSMIT** and **RECEIVE** displays set to SIGNAL [8 Mb/s] and Cable Simulator #2 fitted in place of Cable Simulator #1.

34.368 Mb/s

29. Repeat steps 1 to 18 (20dB and 26dB tests) with the HP 37717C **TRANSMIT** and **RECEIVE** displays set to SIGNAL [34 Mb/s] and Cable Simulator #3 fitted in place of Cable Simulator #2.

Performance Tests

SPDH Receiver Monitor Levels (Options UKJ, [USA], UKL, [USC], UKN, [USE])

139.264 Mb/s

30. Repeat steps 1 to 18 (20dB and 26dB tests) with the HP 37717C **TRANSMIT** and **RECEIVE** displays set to SIGNAL [140 Mb/s] and Cable Simulator #4 fitted in place of Cable Simulator #3.

31. Disconnect all test equipment.

External 2Mb/s Mux/Demux (Options UKJ, [USA], UKN, [USA])

Specifications

Multiplexer:

Frequency	2.048 Mb/s
Interface	Meets ITU Rec. G.703, for unbalanced coaxial pair.HDB3 line coding only.
Source	Accepts a 2 Mb/s signal conforming to ITU Rec. G.703, Unbalanced only.

De-Multiplexer

Frequency	2.048 Mb/s
Interface	Meets section 6 of ITU Rec. G.703, for unbalanced coaxial pair. HDB3 line coding only.

Description

This test verifies operation of the SPDH Mux and demux hardware and confirms the output characteristics of the external demux port on the SPDH Receiver.

The *PDH Test Set* is set up to transmit an Unbalanced 75Ω unframed 2Mb/s pattern. This is applied to the HP 37717C INSERT Port. The 2Mb/s signal is multiplexed into a 140Mb/s data stream. The HP 37717C transmitter and receiver are looped. The unframed 2Mb/s signal is Demultiplexed from the 140Mb/s data stream to the HP 37717C DROP port. The DROP Port signal is then applied to the *PDH Test Set* and a BER test is performed to verify the integrity of the 2 Mb/s signal.

The output from the DROP Port is then applied to an oscilloscope, and the waveform characteristics are checked to ensure they meet specifications.

Equipment Required

Oscilloscope	: HP 54503A
PDH Test Set	: HP 37717C Option UKJ, [USB] or equivalent
75Ω Termination	: HP 15522-80010
50/75Ω Matching Pad	: HP 11852B
T Connector	: HP 1250-0781

NOTE

The *Test Set* used in this procedure is an HP 37717C Option UKJ. Any other PDH Test Set, capable of generating and measuring at 2 Mb/s unframed, can be used.

Procedure

1. Recall the HP 37717C DEFAULT SETTINGS as shown on 3-2.
2. Connect the equipment as shown in Figure 3-24.

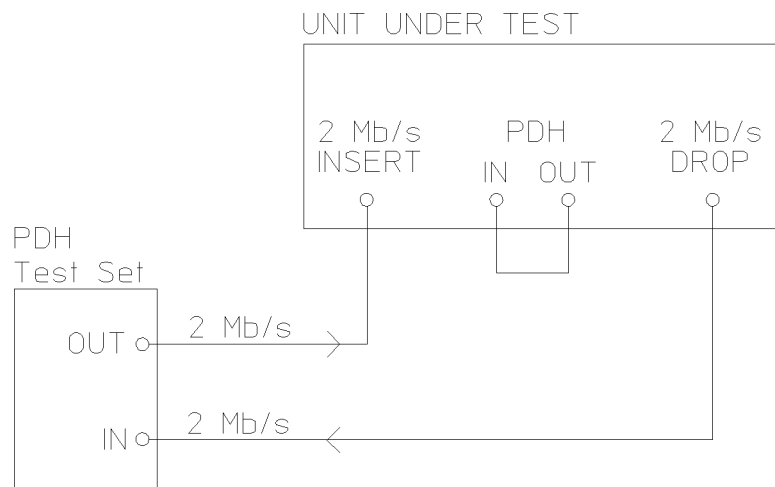

Figure 3-24

External 2 Mb/s Mux/Demux

Performance Tests

External 2Mb/s Mux/Demux (Options UKJ, [USA], UKN, [USA])

3. Press **TRANSMIT** on the *Test Set* and set up the display as shown opposite.

TRANSMITTER OUTPUT	[PDH]
MAIN STRUCT'D TEST	
SETTINGS SETTINGS FUNCTION	
SIGNAL	[2 Mb/s]
CLOCK SYNC	[INTERNAL]
TERMINATION	[75Ω UNBAL]
LINE CODE	[HDB3]
FREQUENCY OFFSET	[OFF]
PAYLOAD TYPE	[UNFRAMED]
PATTERN	[USER WORD] [1000000010000000]
STATUS:	MULTIPLE WINDOW

4. Press **RECEIVE** on the *Test Set* and set up the display as shown opposite.

RECEIVER INPUT	[PDH]
MAIN STRUCT'D	
SETTINGS SETTINGS	
SIGNAL	[2 Mb/s]
TERMINATION	[75Ω UNBAL]
LINE CODE	[HDB3]
LEVEL	[TERMINATE]
PAYLOAD TYPE	[UNFRAMED]
PATTERN	[USER WORD] [1000000010000000]
STATUS:	MULTIPLE WINDOW

5. Press **TRANSMIT** on the HP 37717C and set up the **MAIN SETTINGS** display as shown opposite.

TRANSMITTER OUTPUT	[PDH]
MAIN STRUCT'D TEST	
SETTINGS SETTINGS FUNCTION	
SIGNAL	[140 Mb/s]
CLOCK SYNC	INTERNAL
TERMINATION	75Ω UNBAL
LINE CODE	CM1
FREQUENCY OFFSET	[OFF]
PAYLOAD TYPE	[STRUCTURED]
TO SET TEST SIGNAL, FIRST SELECT THE 'STRUCT'D SETTINGS' FOLDER ABOVE.	
STATUS:	MULTIPLE WINDOW

Performance Tests

External 2Mb/s Mux/Demux (Options UKJ, [USA], UKN, [USA])

6. Press **TRANSMIT** on the HP 37717C and set up the **STRUCTURED SETTINGS** display as shown opposite.

TRANSMITTER OUTPUT	[PDH]
MAIN SETTINGS	STRUCTURED TEST FUNCTION
TEST SIGNAL	[2 Mb/s]
2M PAYLOAD	[INSERT 2Mb/s]
	[34Mb] [8Mb] [2Mb]
	[1] [1] [1]
B/G PATTERN	[AIS]
STATUS:	MULTIPLE WINDOW

7. Press **RECEIVE** on the HP 37717C and set up the **MAIN SETTINGS** display as shown opposite.

RECEIVER INPUT	[PDH]
MAIN SETTINGS	STRUCTURED SETTINGS
SIGNAL	[140 Mb/s]
TERMINATION	75Ω UNBAL
LINE CODE	CMI
LEVEL	[TERMINATE]
PAYLOAD TYPE	[STRUCTURED]
TO SET TEST SIGNAL, FIRST SELECT THE 'STRUCT'D SETTINGS' FOLDER ABOVE	
STATUS:	MULTIPLE WINDOW

8. Press **RECEIVE** on the HP 37717C and set up the **STRUCTURED SETTINGS** display as shown opposite.

RECEIVER INPUT	[PDH]
MAIN SETTINGS	STRUCTURED SETTINGS
TEST SIGNAL	[2 Mb/s]
2M PAYLOAD	[DROP 2Mb/s]
	[34Mb] [8Mb] [2Mb]
	[1] [1] [1]
STATUS:	MULTIPLE WINDOW

9. Press **RUN/STOP** on the Test Set. Press **RESULTS** PDH on the Test Set and ensure that the Bit Error Count and Code Error Count are both zero.

10. Press SINGLE error add key on the Test Set and ensure the Bit Error count increments by one each time the key is pressed.

11. Disconnect the UUT Drop Port from the Test Set and connect this to the oscilloscope Input 1 via a 75Ω termination and "T" connector. Set the oscilloscope termination to 1MΩ and press **AUTOSCALE**.

Performance Tests

External 2Mb/s Mux/Demux (Options UKJ, [USA], UKN, [USA])

12. Adjust the Oscilloscope Timebase and Delay to position the positive peak pulse amplitude at mid-pulse-width point in the centre of the screen.
13. Measure the peak pulse amplitude at mid-pulse-width using the Oscilloscope and verify that this is between 2.133V and 2.607V.
14. Select the 2Mb G.703 mask on the oscilloscope and store it on the display.
15. Press SHIFT **AUTOSCALE** on the oscilloscope to automatically align the pulse to the mask. Verify that the pulse falls within the mask as shown in Figure 3-25.

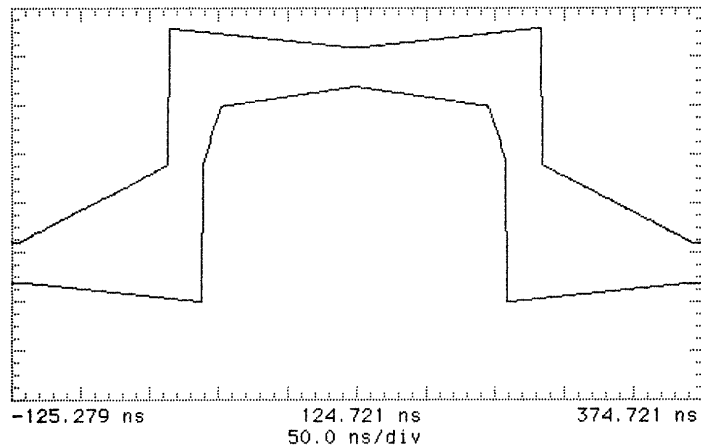

Figure 3-25

2 Mb/s Pulse Mask

NOTE

If your oscilloscope does not have the Mask feature, obtain a printout of the displayed pulse. Place the mask, shown in Figure 3-25, over the pulse and ensure that the pulse falls within the mask. (A transparent copy of the mask should be used).

16. Press **AUTOSCALE** on the oscilloscope to display the full waveform.
17. Use the following sequence to display the isolated negative pulse.
 - Select **TRIG** menu.
 - Set trigger level to middle of negative pulse.
 - Set trigger to pattern.
 - Set sequence to H X X.

Performance Tests

External 2Mb/s Mux/Demux (Options UKJ, [USA], UKN, [USA])

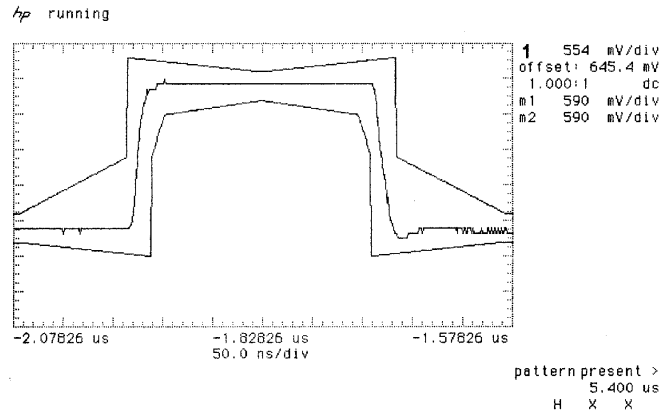

Figure 3-26

2 Mb/s Isolated Positive Pulse

18. Use the oscilloscope **STORE INVERT** to display an inverted mask on the oscilloscope.

19. Adjust the oscilloscope timebase and vertical sensitivity controls to verify that the pulse meets the mask as shown in Figure 3-27. Use the displayed settings as a guide.

20. Measure the peak pulse amplitude at mid-pulse-width using the Oscilloscope and verify that this is between 2.133V and 2.607V.

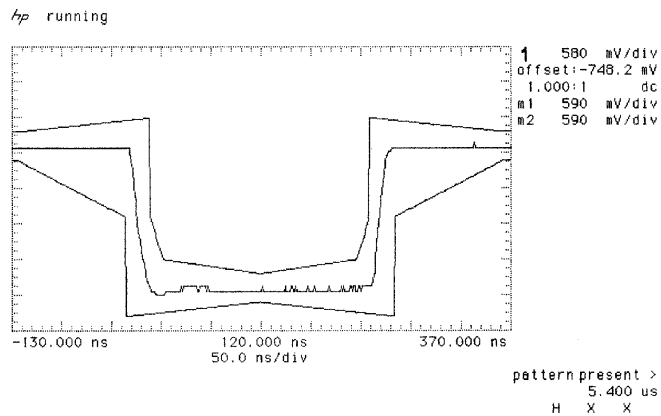

Figure 3-27

2 Mb/s Isolated Negative Pulse

Performance Tests

External 2Mb/s Mux/Demux (Options UKJ, [USA], UKN, [USA])

21. Ensure that the ratio of +ve and -ve pulse amplitudes is between 0.95 and 1.05.
22. Ensure that the ratio of +ve and -ve pulse widths is between 0.95 and 1.05.
23. Disconnect all test equipment.

External 2Mb/s Demux (Options UKL, [USC])

Specifications

Frequency	2.048 Mb/s
Interface	Meets section 6 of ITU Rec. G.703, for unbalanced coaxial pair. HDB3 line coding only.

Description

This test verifies operation of the demux hardware and confirms the output characteristics of the external demux port on the SPDH Receive Only option.

The *Structured PDH Test Set* is set up to transmit a structured 140Mb/s signal containing an unframed 2Mb/s pattern. This is applied to the HP 37717C PDH IN Port. The unframed 2Mb/s signal is Demultiplexed from the 140Mb/s data stream to the HP 37717C DROP port. The DROP Port signal is then applied to the *Structured PDH Test Set* and a BER test is performed to verify the integrity of the 2 Mb/s signal.

The output from the DROP Port is then applied to an oscilloscope, and the waveform characteristics are checked to ensure they meet specifications.

Equipment Required

Oscilloscope	: HP 54503A
PDH Test Set	: HP 37717C Option UKJ or equivalent (See Note)
75Ω Termination	: HP 15522-80010
50/75Ω Matching Pad	: HP 11852B
T Connector	: HP 1250-0781

NOTE

The *Test Set* used in this procedure is an HP 37717C Option UKJ. Any other Structured PDH Test Set, capable of generating an unframed 2 Mb/s signal within a structured 140 Mb/s, can be used.

Performance Tests

External 2Mb/s Demux (Options UKL, [USC])

Procedure

1. Recall the HP 37717C DEFAULT SETTINGS as shown on 3-2.
2. Connect the equipment as shown in Figure 3-28.

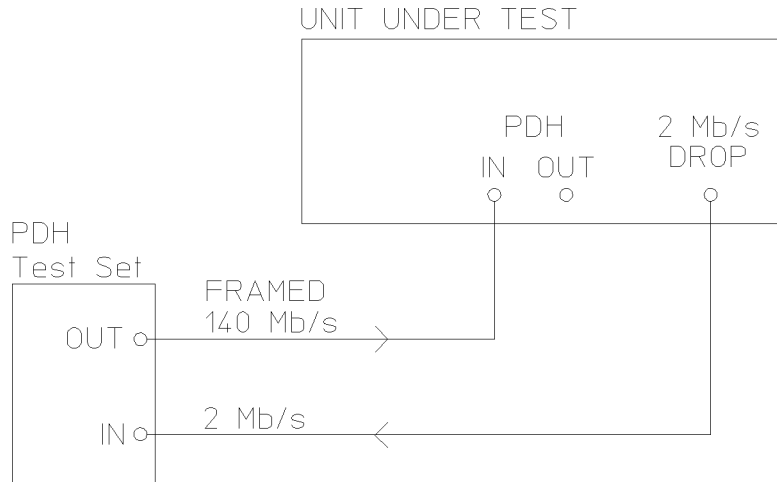

Figure 3-28

External 2 Mb/s Demux

3. Press **TRANSMIT** on the *Test Set* and set up the **MAIN SETTINGS** display as shown opposite.

TRANSMITTER OUTPUT	[PDH]
MAIN SETTINGS	STRUCT'D TEST
SIGNAL	[140 Mb/s]
CLOCK SYNC	INTERNAL
TERMINATION	75Ω UNBAL
LINE CODE	CM1
FREQUENCY OFFSET	[OFF]
PAYLOAD TYPE	[STRUCTURED]
TO SET TEST SIGNAL, FIRST SELECT THE 'STRUCT'D SETTINGS' FOLDER ABOVE.	
STATUS:	MULTIPLE WINDOW

Performance Tests

External 2Mb/s Demux (Options UKL, [USC])

4. Press **[TRANSMIT]** on the *Test Set* and set up the **STRUCTURED SETTINGS** display as shown opposite.

TRANSMITTER OUTPUT	[PDH]
MAIN SETTINGS	STRUCT'D TEST
SETTINGS SETTINGS FUNCTION	
TEST SIGNAL	[2 Mb/s]
2M PAYLOAD	[UNFRAMED]
	[34Mb] [8Mb] [2Mb]
	[1] [1] [1]
PATTERN	[USER WORD]
B/G PATTERN	[1000000010000000]
	[A15]
STATUS:	
	MULTIPLE WINDOW

5. Press **[RECEIVE]** on the *Test Set* and set up the **MAIN SETTINGS** display as shown opposite.

RECEIVER INPUT	[PDH]
MAIN SETTINGS	STRUCT'D
SETTINGS SETTINGS	
SIGNAL	[2 Mb/s]
TERMINATION	[75 Ω UNBAL]
LINE CODE	[HDZS]
LEVEL	[TERMINATE]
PAYLOAD TYPE	[UNFRAMED]
PATTERN	[USER WORD]
	[1000000010000000]
STATUS:	
	MULTIPLE WINDOW

6. Press **[RECEIVE]** on the HP 37717C and set the **MAIN SETTINGS** display as shown below.

RECEIVER INPUT	[PDH]
MAIN SETTINGS	STRUCT'D
SETTINGS SETTINGS	
SIGNAL	[140 Mb/s]
TERMINATION	75 Ω UNBAL
LINE CODE	CMI
LEVEL	[TERMINATE]
PAYLOAD TYPE	[STRUCTURED]
TO SET TEST SIGNAL, FIRST SELECT THE 'STRUCT'D SETTINGS' FOLDER ABOVE	
STATUS:	
	MULTIPLE WINDOW

Performance Tests

External 2Mb/s Demux (Options UKL, [USC])

- Press **RECEIVE** on the HP 37717C and set the **STRUCTURED SETTINGS** display as shown opposite.
- Press **RUN/STOP** on the Test Set. Press **RESULTS** PDH on the *Test Set* and ensure that the Bit Error Count and Code Error Count are both zero.
- Press **SINGLE** error add key on the *Test Set* and ensure the Bit Error count increments by one each time the key is pressed.
- Disconnect the Drop Port from the *Test Set* and connect it to the oscilloscope Input 1 via a "T" connector and a 75 Ω termination. Set the oscilloscope termination to 1M Ω and press **AUTOSCALE**.
- Adjust the Oscilloscope Timebase and Delay to position the positive peak pulse amplitude at mid-pulse-width point in the centre of the screen.
- Measure the peak pulse amplitude at mid-pulse-width using the Oscilloscope and verify that this is between 2.133V and 2.607V.
- Select the 2Mb G.703 mask on the oscilloscope and store it on the display.
- Press SHIFT **AUTOSCALE** on the oscilloscope to automatically align the pulse to the mask. Verify that the pulse falls within the mask as shown in Figure 3-30.

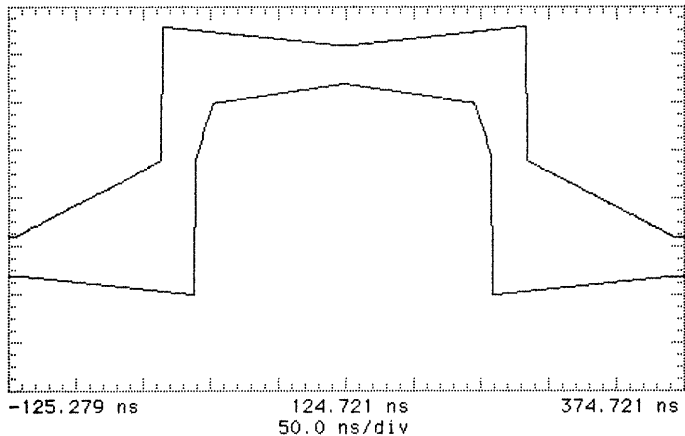
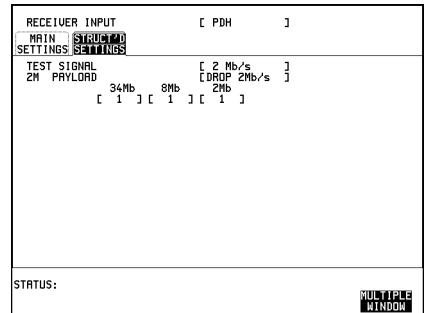

Figure 3-29

2 Mb/s Pulse Mask

Performance Tests

External 2Mb/s Demux (Options UKL, [USC])

NOTE

If your oscilloscope does not have the Mask feature, obtain a printout of the displayed pulse. Place the mask, shown in Figure 3-29, over the pulse and ensure that the pulse falls within the mask. (A transparent copy of the mask should be used).

15. Press **AUTOSCALE** on the oscilloscope to display the full waveform.

16. Use the following sequence to display the isolated negative pulse.

Select **TRIG** menu.

Set trigger level to middle of negative pulse.

Set trigger to pattern.

Set sequence to H X X.

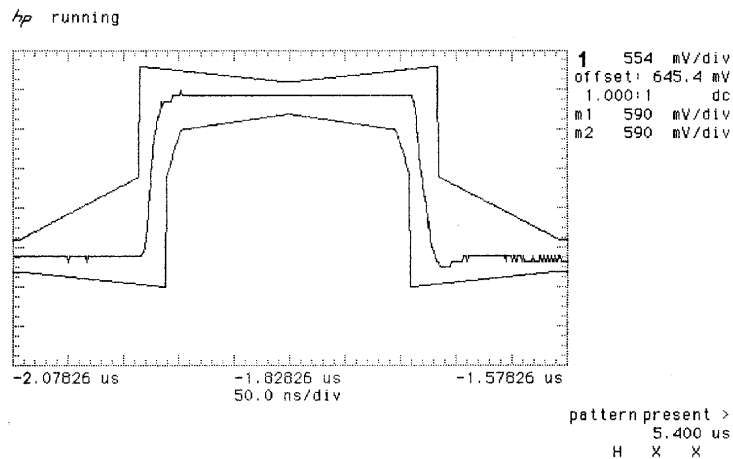

Figure 3-30

2 Mb/s Isolated Positive Pulse

17. Use the oscilloscope **STORE INVERT** to display an inverted mask on the oscilloscope.

18. Adjust the oscilloscope timebase and vertical sensitivity controls to verify that the pulse meets the mask as shown in Figure 3-31. Use the displayed settings as a guide.

19. Measure the peak pulse amplitude at mid-pulse-width using the Oscilloscope and verify that this is between 2.133V and 2.607V.

Performance Tests
External 2Mb/s Demux (Options UKL, [USC])

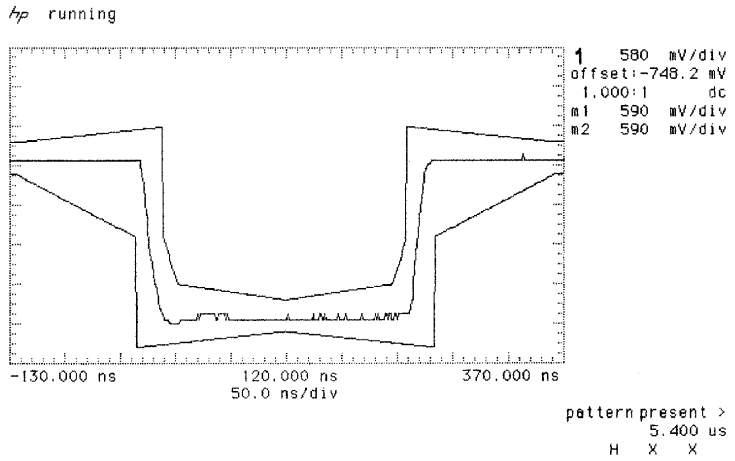

Figure 3-31 2 Mb/s Isolated Negative Pulse

20. Ensure that the ratio of +ve and -ve pulse amplitudes is between 0.95 and 1.05.
21. Ensure that the ratio of +ve and -ve pulse widths is between 0.95 and 1.05.
22. Disconnect all test equipment.

PDH Receiver Monitor Levels (Special Option 808)

Specification

Bit Rate	Nominal Loss	Equalization at 1/2 Bit Rate
704 kb/s	20dB Flat	3dB
2.048 Mb/s	20dB Flat	3dB
8.448 Mb/s	20dB Flat	3dB
34.368 Mb/s	20dB Flat	6dB
139.264 Mb/s	20dB Flat	6dB

Description

Option 808 provides an equalized Monitor input. This is checked by attenuating the synthesizer output level by an amount equivalent to the extra gain provided by the Monitor Amplifier. The synthesizer is set to generate a sinewave at half the bit rate which corresponds to a ternary all ones signal. The receiver should sync up with no errors if PATTERN [ALL ONES] is selected.

Equipment Required

Synthesizer : HP 3335A option 001 (75 Ω)

Oscilloscope : HP 54503A

Procedure

1. Recall the HP 37717C DEFAULT SETTINGS as shown on 3-2.
2. Connect up the equipment as shown in Figure 3-32.
3. Set the oscilloscope to: TERMINATION - 1 M Ω PROBE - 1:1

Performance Tests

PDH Receiver Monitor Levels (Special Option 808)

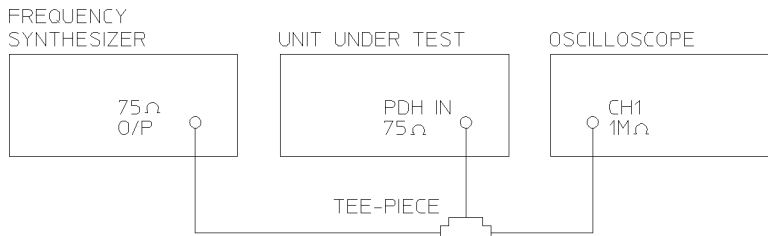
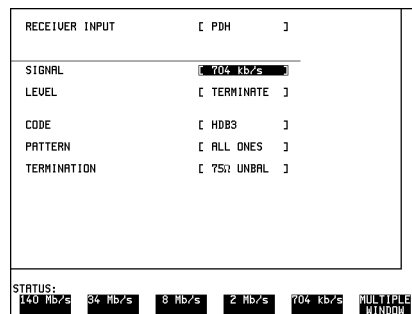

Figure 3-32

PDH Receiver Monitor Levels Test Setup

704 kb/s

4. Press **RECEIVE** and set up the display as shown below. Press **SIGNAL IN** until the Monitor led is lit.



5. Select **RESULTS** **TIMING** **CONTROL** TEST TIMING [SINGLE] [5 SECS]

6. Press **RESULTS** and set up the display as shown below.

7. Set the Synthesizer to: FREQUENCY - 352 KHz sinewave AMPLITUDE - 237.5 mV pk-pk (26dB down) as measured on the oscilloscope.

8. Press **RUN/STOP** and verify that no errors are displayed at the end of the test period (5 seconds).

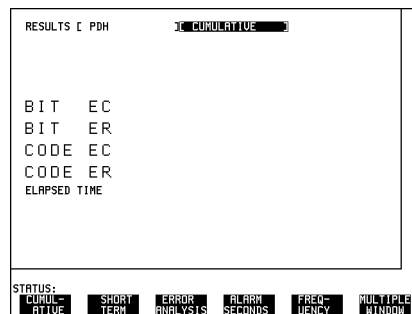

Performance Tests

PDH Receiver Monitor Levels (Special Option 808)

2.048 Mb/s

9. Select SIGNAL [2 Mb/s] on the **RECEIVE** display.
10. Set the Synthesizer to: FREQUENCY - 1024 KHz sinewave AMPLITUDE - 237.5 mV pk-pk (26dB down) as measured on the oscilloscope.
11. Press **RUN/STOP** and verify that no errors are displayed at the end of the test period (5 seconds).

8.448 Mb/s

12. Select SIGNAL [8 Mb/s] on the **RECEIVE** display.
13. Set the Synthesizer to: FREQUENCY - 4224 KHz sinewave AMPLITUDE - 237.5 mV pk-pk (26dB down) as measured on the oscilloscope.
14. Press **RUN/STOP** and verify that no errors are displayed at the end of the test period (5 seconds).

34.368 Mb/s

15. Select SIGNAL [34 Mb/s] on the **RECEIVE** display.
16. Set the Synthesizer to: FREQUENCY - 17184 KHz sinewave AMPLITUDE - 71 mV pk-pk (29dB down) as measured on the oscilloscope.
17. Press **RUN/STOP** and verify that no errors are displayed at the end of the test period (5 seconds).

139.264 Mb/s

18. Select SIGNAL [140 Mb/s] on the **RECEIVE** display.
19. Set the Synthesizer to: FREQUENCY - 69632 KHz sinewave AMPLITUDE - 50 mV pk-pk (26dB down) as measured on the oscilloscope.
20. Press **RUN/STOP** and verify that no errors are displayed at the end of the test period (5 seconds).

PDH Error Output (Options UKK, [USB])

NOTE

A PDH Tx Module must be fitted for this test - see Appendix B.

Specifications

Output	1 pulse per error
Output During Sync Loss	Continuous pulses at 16 Clock period intervals
Pulse Width	Nominal 8 clock periods
Level	Nominal ECL

Description

The HP 37717C Transmitter generates a 2Mb/s Bit stream with injected errors. These errors are counted by the receiver and the signal appearing at the Error Output Port is checked to verify that error pulses are present at the correct rate. The Error Output signal is also checked with Pattern Sync Loss to verify that pulses are still present at 16 Clock Period intervals.

Equipment Required

Oscilloscope	: HP 54503A
Blocking Capacitor	: HP 10240B

Procedure

1. Recall the HP 37717C DEFAULT SETTINGS as shown on 3-2.
2. Connect the HP 37717C SIGNAL OUT 75 Ω port to the SIGNAL IN 75 Ω port.
3. Connect the HP 37717C ERROR OUT port to the Oscilloscope Channel 1 via the Blocking Capacitor (terminate scope in 1M Ω).
4. Select SIGNAL [2 Mb/s] on the **TRANSMIT** and **RECEIVE** displays.

Performance Tests

PDH Error Output (Options UKK, [USB])

5. Press **RESULTS** and set up the display as shown opposite.
6. Press **RUN/STOP** to start a measurement.
7. Check that the displayed BIT EC result is 0.
8. Press **TRANSMIT**, set up the TEST FUNCTION display as shown below to add errors to the signal and check that the BIT ER result is 1 in 10^{-3} .

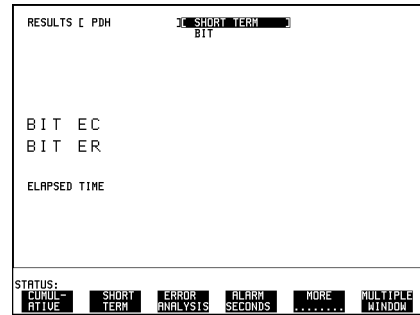
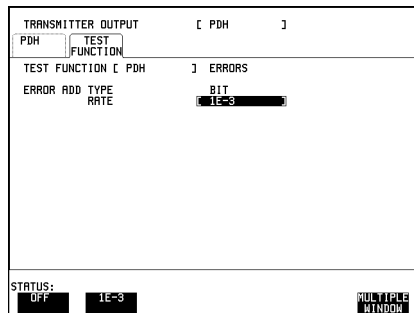

Error Output Signal

9. Adjust the Timebase and Range of the Oscilloscope to display two pulses.
10. Check that the pulse period is approximately 488uS (1 pulse per error - 1000 clock periods).
11. Press **TRANSMIT** and set the TEST FUNCTION ERROR ADD RATE to OFF to stop the error add. Check that pulses are no longer present on the Oscilloscope.
12. Select PATTERN [2^23-1] on the **RECEIVE** display and check that the Pattern Loss LED is lit.
13. Adjust the Timebase and Range of the Oscilloscope to display a single pulse.
14. Check that the pulse period is 7.8uS (continuous pulses).
15. Disconnect all the equipment.

PDH Frequency Measurement and Looped Clock (Options UKK, [USB], UKJ, [USA], UKL, [USC], UKN, [USE])

**PDH Frequency Measurement and Looped Clock
(Options UKK, [USB], UKJ, [USA], UKL, [USC], UKN,
[USE])**

Specifications

Accuracy ± 7 ppm

Measured Offset ± 100 ppm

Description

This test verifies that the HP 37717C Receiver Frequency Measurement is within specified limits. These limits assume the instrument is within the annual calibration cycle.

A Synthesizer is used to generate a sinewave at half the data rate. This is applied to the HP 37717C Receiver Signal In port. As this signal corresponds to an *All Ones Ternary Signal*, the HP 37717C receiver should sync up with no errors if set to PATTERN [ALL ONES]. The Frequency Measurement accuracy of the HP 37717C can be determined by comparison with the frequency displayed on the Synthesizer. Frequency Offset Measurement is also verified during this test as the HP 37717C will display deviation from the expected Signal In frequency in ppm. The PDH transmitter recovered clock function is also verified at 2 Mb/s using the frequency counter in RATIO mode.

Equipment Required

Synthesizer : HP 3335A Option 010 (75 Ω)

Frequency Counter : HP 5335A Option 010

Procedure

1. Recall the HP 37717C DEFAULT SETTINGS as shown on 3-2.
2. Connect up the equipment as shown in Figure 3-33.

Performance Tests

PDH Frequency Measurement and Looped Clock (Options UKK, [USB], UKJ, [USA], UKL, [USC], UKN, [USE])

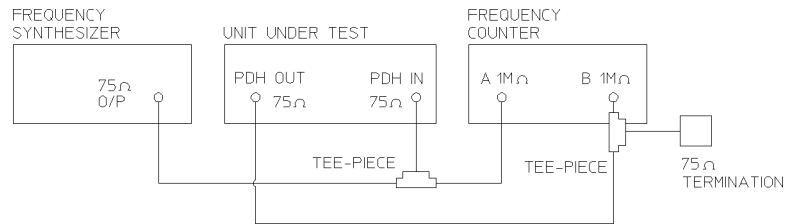
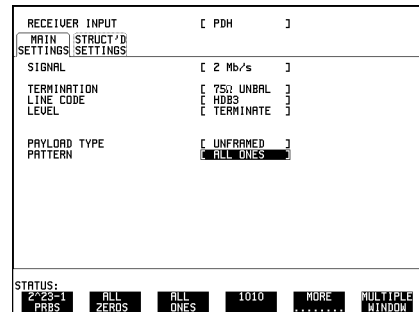
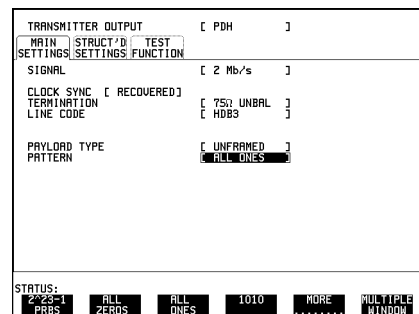

Figure 3-33 Receiver Frequency Measurement Test Setup

3. Set the Synthesizer to: FREQUENCY - 1024.000 kHz sinewave AMPLITUDE - +10dBm.
4. Set the frequency counter to RATIO A/B.
5. Press **RECEIVE** and set up the display as shown opposite.



6. Press **TRANSMIT** and set up the display as shown opposite.



Performance Tests

PDH Frequency Measurement and Looped Clock (Options UKK, [USB], UKJ, [USA], UKL, [USC], UKN, [USE])

7. Press **RESULTS** and set up the display as shown opposite. (If MEASUREMENT TIME field is present, set to 16 seconds.)
8. Verify that the FREQUENCY displayed is between 2047986 Hz and 2048014 Hz.
9. Verify that the Offset displayed is between +7 ppm and -7 ppm.
10. Set the synthesizer frequency to 1024.102 kHz and verify that the frequency displayed on the **RESULTS** display is between 2048.190 kHz and 2048.219 kHz.
11. Verify that the Offset displayed is between 93 ppm and 107 ppm. The frequency counter should read 1.00.
12. Set the synthesizer frequency to 1023.898 kHz and verify that the frequency displayed on the **RESULTS** display is between 2047.781 kHz and 2047.810 kHz.
13. Verify that the Offset displayed is between -93 ppm and -107 ppm. The frequency counter should read 1.00.
14. Set the synthesizer and the HP 37717C to the settings given in Table 3-3 and verify the displayed Offset at each point.

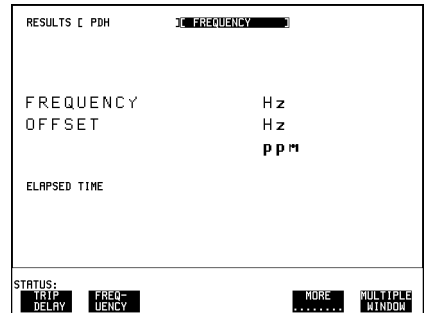

Table 3-3 Measured Offset

Option	Receive Frequency	Synthesizer Frequency	Synthesizer Level	Displayed Offset
UKK, [USB]	704 kb/s	352.000 kHz	+10 dBm	-7 to +7 ppm
UKK, [USB]	704 kb/s	351.965 kHz	+10 dBm	-93 to -107 ppm
UKK, [USB]	704 kb/s	352.035 kHz	+10 dBm	+93 to +107 ppm
UKK, [USB], UKJ, [USA]	8 Mb/s	4224.000 kHz	+10 dBm	-7 to +7 ppm
UKK, [USB], UKJ, [USA]	8 Mb/s	4223.578 kHz	+10 dBm	-93 to -107 ppm
UKK, [USB], UKJ, [USA]	8 Mb/s	4224.422 kHz	+10 dBm	+93 to +107 ppm
UKK, [USB], UKJ, [USA]	34 Mb/s	17,184.000 kHz	+10 dBm	-7 to +7 ppm
UKK, [USB], UKJ, [USA]	34 Mb/s	17,182.282 kHz	+10 dBm	-93 to -107 ppm
UKK, [USB], UKJ, [USA]	34 Mb/s	17,185.718 kHz	+10 dBm	+93 to +107 ppm
UKK, [USB], UKJ, [USA]	140 Mb/s	69,632.000 kHz	+4 dBm	-7 to +7 ppm

Performance Tests

PDH Frequency Measurement and Looped Clock (Options UKK, [USB], UKJ, [USA], UKL, [USC], UKN, [USE])

Table 3-3 Measured Offset continued

Option	Receive Frequency	Synthesizer Frequency	Synthesizer Level	Displayed Offset
UKK, [USB], UKJ, [USA]	140 Mb/s	69,625.036 kHz	+4 dBm	-93 to -107 ppm
UKK, [USB], UKJ, [USA]	140 Mb/s	69,638.963 kHz	+4 dBm	+93 to +107 ppm

Internal SDH Transmitter Clock (Options US1, [US5], A1T, [A1U], A3R [A3S])

Internal SDH Transmitter Clock (Options US1, [US5], A1T, [A1U], A3R [A3S])

Specification

Bit Rate	Accuracy
155.52 Mb/s	± 4.5 ppm

Description

The test uses a Frequency Counter connected to the SDH Signal Out port to measure the STM-1 All Ones data rate. This gives an indirect measure of the transmitter clock frequency as the data is clocked by the internal 10MHz clock oscillator. The test limits assume the instrument is within the annual calibration cycle. The STM-1 Framing is disabled for this test using the MODULE DEBUG function of the HP 37717C.

Equipment Required

- Frequency Counter** : HP 5335A Option 010
- 75 Ω Termination** : HP 15522-80010
- T Connector** : HP 1250-0781

Procedure

1. Recall the HP 37717C DEFAULT SETTINGS as shown on 3-2.
2. Connect the HP 37717C STM-1 OUT port to the Frequency Counter Input A, terminated in 75 Ω (use the T Connector).

Performance Tests

Internal SDH Transmitter Clock (Options US1, [US5], A1T, [A1U], A3R [A3S])

3. Press **TRANSMIT** **SDH** **SDH** and set up the display as shown opposite.

TRANSMITTER OUTPUT [SDH]	
SDH	STRUCT'D [TEST] OVERHEAD
PAYLOAD	FUNCTION [SETUP]
SIGNAL	STM-1 [INTERNAL]
CLOCK SYNC	[INTERNAL]
FREQUENCY OFFSET	[OFF]
MAPPING	RU-4 [UC-4] 140 Mb/s
PAYLOAD TYPE	[UNFRAMED]
PATTERN	[ALL ONES]
140M OFFSET	[0 ppm]
STATUS:	
	MULTIPLE WINDOW

4. Make the following key sequence on the HP 37717C to obtain the special **MODULE DEBUG** display.

Press **OTHER**; **←**; **MORE**; **←**;
MORE; **←**; **MORE**; **OTHER**.

Press **MORE** until **MODULE DEBUG** appears in the softkey menu.

Press **MODULE DEBUG** and set up the display as shown opposite.

FUNCTION [MODULE DEBUG]	
MODULE	[SDH MODULE]
DOWNLOAD LCA DESIGN	[]
INTO H/W SITE NUMBER	[]
TOGGLE TO DOWNLOAD	[OFF]
STM-1 TEST PATTERN	[ALL ONES]
TU ASIC REGISTER [0000]	
IMAGE
ODL (-----) TWPAT (-----)	
SPARE (-----) TXMAP (-----)	
RXPAT (-----) BKGND (-----)	
RADWP (-----) DISCRIM (-----)	
LPTHRU (-----) DRTCPAT (-----)	
STATUS:	
OFF	ALL ONES ALL ZEROS MULTIPLE WINDOW

CAUTION

When using the **MODULE DEBUG** display, ONLY modify the STM-1 TEST PATTERN. Altering other parameters can damage instrument firmware - exit this display after setup to eliminate any possibility of accidental modification.

- Adjust the Frequency Counter Trigger Level to obtain a stable reading and ensure that the Frequency Counter reads between 77.759650 MHz and 77.760350 MHz.
- Disconnect all the test equipment.

SDH Frequency Offsets (Options US1, [US5], A1T, [A1U], A3R [A3S], 120)

Specifications

Range	±999 ppm
Resolution	0.1 ppm
Accuracy	0.02 ppm (from 0 to ± 100 ppm) 0.2 ppm (from ±100 to ±999 ppm)

Description

The SDH Transmitter Offset Clock is checked for range and accuracy using a Frequency Counter to measure the STM-1 Data rate. This gives an indirect measure of the transmitter clock frequency as the data is clocked by the internal 10MHz clock oscillator. A measurement with no offset is performed to establish a reference Clock frequency. The frequency accuracy is then measured over the specified offset range. The STM-1 Framing is disabled during this test using the **MODULE DEBUG** function of the HP 37717C.

Equipment Required

Frequency Counter	: HP 5335A Opt 010
T Connector	: HP 1250-0781

Procedure

1. Recall the HP 37717C DEFAULT SETTINGS as shown on 3-2.
2. Connect the STM-1 OUT port to the Frequency Counter terminated in 75Ω (use the T connector).

Performance Tests

SDH Frequency Offsets (Options US1, [US5], A1T, [A1U], A3R [A3S], 120)

3. Press **TRANSMIT** and set up the display as shown opposite.

TRANSMITTER OUTPUT	[SDH]		
SDH	STRUCT'D	TEST	OVERHEAD
	PAYLOAD	FUNCTION	SETUP
SIGNAL	STM-1	[INTERNAL]	
CLOCK SYNC	[INTERNAL]		
FREQUENCY OFFSET	[ON]	[+0.0]	
MAPPING	AU-4	[UC-4]	[140 Mb/s]
PAYLOAD TYPE	[UNFRAMED]		
PATTERN	[ALL ONES]		
140M OFFSET	[0 ppm]		
STATUS:			
			MULTIPLE WINDOW

4. Make the following key sequence on the HP 37717C to obtain the special **MODULE DEBUG** display.

Press **OTHER**; **←**; **MORE**; **←**;
MORE; **←**; **MORE**; **OTHER**.

Press **MORE** until **MODULE DEBUG** appears in the softkey menu.

Press **MODULE DEBUG** and set up the display as shown opposite.

FUNCTION	[MODULE DEBUG]
MODULE	[SDH MODULE]
DOWNLOAD LCA DESIGN	[.]
INTD H/W SITE NUMBER	[.]
TOGGLE TO DOWNLOAD	[OFF]
STM-1 TEST PATTERN	[ALL ONES]
TU ASIC REGISTER [0000]	
IMAGE
ODL (-----)	TMPRAT (-----)
SPRRE (-----)	TMKRP (-----)
RPFRAT (-----)	BKNGND (-----)
RHDMP (-----)	DISCRIN (-----)
LPTHRU (-----)	DATCPTR (-----)
STATUS:	
OFF	ALL ONES ALL ZEROS
MULTIPLE WINDOW	

CAUTION

When using the **MODULE DEBUG** display, **ONLY** modify the STM-1 TEST PATTERN. Altering other parameters can damage instrument firmware - exit this display after setup to eliminate any possibility of accidental modification.

5. Adjust the Frequency Counter Trigger Level to obtain a stable reading.
6. Take note of the measured frequency (MF).
7. Select the frequency offset settings given in Table 3-4 and verify the frequency at each step against the measured frequency (MF) noted in step 6.

Performance Tests

SDH Frequency Offsets (Options US1, [US5], A1T, [A1U], A3R [A3S], 120)

Table 3-4 Measured Offset

Offset (ppm)	Min Expected Frequency	Max Expected Frequency
-100ppm	$MF - (0.00010452 \times MF)$	$MF - (0.00009548) \times MF$
-66.6ppm	$MF - (0.00007114 \times MF)$	$MF - (0.00006208) \times MF$
+33.3ppm	$MF + (0.00002878 \times MF)$	$MF + (0.00003782) \times MF$
+100ppm	$MF + (0.00009548 \times MF)$	$MF + (0.00010452) \times MF$
+999ppm	$MF + (0.00099448 \times MF)$	$MF + (0.00100352) \times MF$
-999ppm	$MF - (0.00100352 \times MF)$	$MF - (0.00099448) \times MF$

8. Disconnect all the test equipment.

External MTS Clock (Options US1, [US5], A1T, [A1U], A3R [A3S], 120)

Specifications

Accepts Timing Reference as per ITU G.811

Description

This test verifies that signal integrity is maintained when the EXT MTS clock is used as a reference.

Equipment Required

- Synthesizer** : HP 3335A option 001 (75 Ω)
- 2 Mb/s PDH Test Set** : HP 37717A/B option UKK or UKJ or
: HP 37714A option UKK or UKJ or
: HP 37721A
- 75 Ω /120 Ω Converter** : HP 15508B

Procedure

External MTS - 2MHz Clock

1. Connect the STM-1 OUT port to the STM-1 IN port and Recall HP 37717C DEFAULT SETTINGS as shown on 3-2.
2. Press **TRANSMIT** and set up the display as shown opposite.
3. Connect the HP 3335A to the HP 37717C Unbalanced 75 Ω 2M REF IN port (EXT MTS clock).
4. Set the HP 3335A to 2.048 MHz at 2.0V p-p.

TRANSMITTER OUTPUT	[SDH]		
SDH	STRUCT'D	TEST	OVERHEAD
PAYLOAD	FUNCTION	SETUP	
SIGNAL	STM-1	[INTERNAL]	
CLOCK SYNC	[EXT MTS]	[CLOCK]	
FREQUENCY OFFSET	[OFF]		
MAPPING	AU-4 [UC-4]	[140 Mb/s]	
PAYLOAD TYPE	[UNFRAMED]		
PATTERN	[2 ⁿ 23-1 PRBS]	[INVERT]	[ITU]
140M OFFSET	[0 ppm]		
STATUS:			MULTIPLE WINDOW

Performance Tests

External MTS Clock (Options US1, [US5], A1T, [A1U], A3R [A3S], 120)

5. Press **RECEIVE** and set up the display as shown opposite.

6. Press **RESULTS**; **TROUBLE SCAN**.

7. Press **RUN/STOP**, check that the display reads NO TROUBLE and all the Alarm leds are off.

8. Press **RUN/STOP** to halt the measurement.

9. Disconnect the HP 3335A and check that the CLOCK LOSS led is on, but the display reads NO TROUBLE.

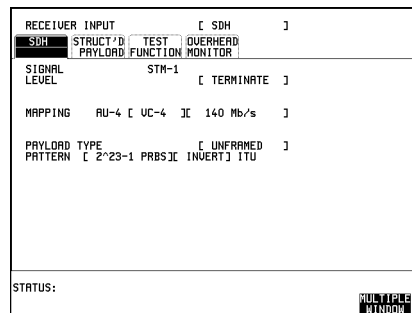

External MTS - 2MHz Data

10. Select CLOCK : EXTERNAL [MTS 2M DATA].

11. Set the HP 3335A to output a 1.024MHz, 2V p-p signal.

12. Connect the HP 3335A to the 75Ω 2M REF IN port.

13. Press **RUN/STOP** to start the measurement and check that the RESULTS display reads NO TROUBLE and all the Alarm leds are off.

14. Disconnect the HP 3335A and check that the CLOCK LOSS led is on.

15. Connect the HP 3335A via the 75Ω/120Ω Converter to the 120Ω 2M REF IN port.

16. Press **RUN/STOP** and check that the RESULTS display reads NO TROUBLE and all the Alarm leds are off.

BITS 1.5 Mb/s (Option 120 only)

17. Select CLOCK : EXTERNAL [BITS : 1.5M].

18. Set the HP 3335A to output a 772kHz, 2V p-p signal.

19. Connect the HP 3335A to the 100Ω 1.5M REF IN port.

20. Press **RUN/STOP** and check that the RESULTS display reads NO TROUBLE and all the Alarm leds are off.

Performance Tests

External MTS Clock (Options US1, [US5], A1T, [A1U], A3R [A3S], 120)

External - MTS 64k Clock

21. Select CLOCK : EXTERNAL [MTS 64K CLOCK].
22. Set the HP 3335A to output a 32kHz, 2V p-p signal.
23. Connect the HP 3335A to the 100 Ω 64K REF IN port.
24. Press **RUN/STOP** and check that the RESULTS display reads NO TROUBLE and all the Alarm leds are off.

STM-1 RX

25. Select CLOCK : STM-1 [RX].
26. Set the HP 3335A to output a 77.760MHz, 2V p-p signal.
27. Connect the HP 3335A to the STM-1 IN port and check that the CLOCK LOSS led is off. (Ignore any other Alarm leds.)

STM-1 Transmitter Output Waveshape (Options US1, [US5], A1T, [A1U], A3R [A3S], 120)

STM-1 Transmitter Output Waveshape (Options US1, [US5], A1T, [A1U], A3R [A3S], 120)

Specifications

Meets ITU Recommendation G.703

Description

An oscilloscope is connected to the HP 37717C Transmitter STM-1 output and used to view the waveforms with All Ones and All Zeros patterns selected in turn. The displayed waveshape is checked against the relevant ITU G.703 mask. The STM-1 Framing is disabled during this test using the **MODULE DEBUG** function of the HP 37717C.

Equipment Required

- Oscilloscope** : HP 54503A
- ThinkJet Printer** : HP 2225A
- 75Ω Termination** : HP 15522-80010
- T Connector** : HP 1250-0781

Procedure

CMI All Ones Waveshape

1. Connect up the equipment as shown in Figure 3-34 and recall HP 37717C DEFAULT SETTINGS as shown on 3-2.

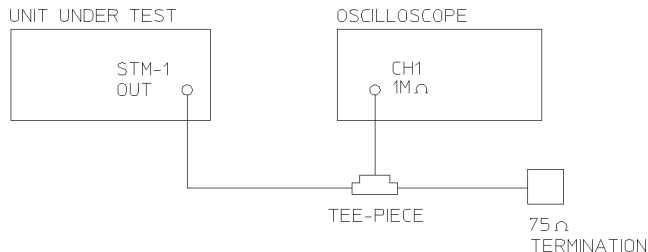

Figure 3-34

STM-1 Transmitter Output Waveshape Test Setup

Performance Tests

STM-1 Transmitter Output Waveshape (Options US1, [US5], A1T, [A1U], A3R [A3S], 120)

2. Press **TRANSMIT** and set up the display as shown opposite.

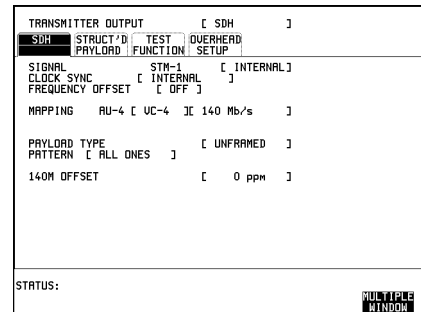

3. Make the following key sequence on the HP 37717C to obtain the special **MODULE DEBUG** display.

Press **OTHER**; **←**; **MORE**; **←**;
MORE; **←**; **MORE**; **OTHER**.

Press **MORE** until **MODULE DEBUG** appears in the softkey menu.

Press **MODULE DEBUG** and set up the display as shown opposite.

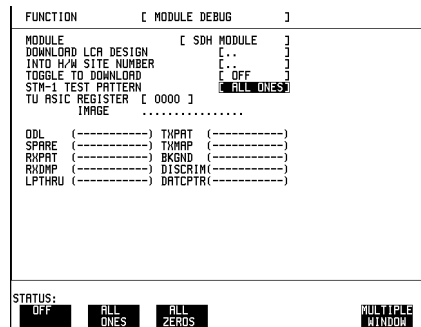

CAUTION

When using the **MODULE DEBUG** display, ONLY modify the STM-1 TEST PATTERN. Altering other parameters can damage instrument firmware - exit this display after setup to eliminate any possibility of accidental modification.

4. Adjust the Oscilloscope controls to display the waveform as shown in Figure 3-35, STM-1 All Ones Pattern.
5. Use the Oscilloscope PRINT function to obtain a printout of the STM-1 waveform on the external printer.
6. Ensure this printout fits the STM-1 Mask of Figure 3-36.

NOTE

If a mylar mask is not available, the figure shown may be traced or photocopied onto a transparency.

Performance Tests

STM-1 Transmitter Output Waveshape (Options US1, [US5], A1T, [A1U], A3R [A3S], 120)

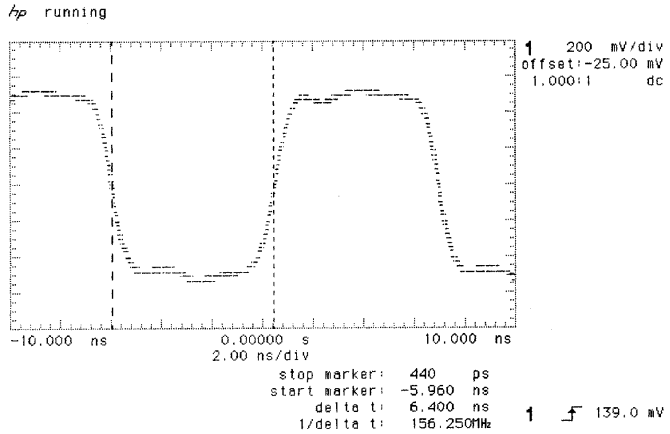
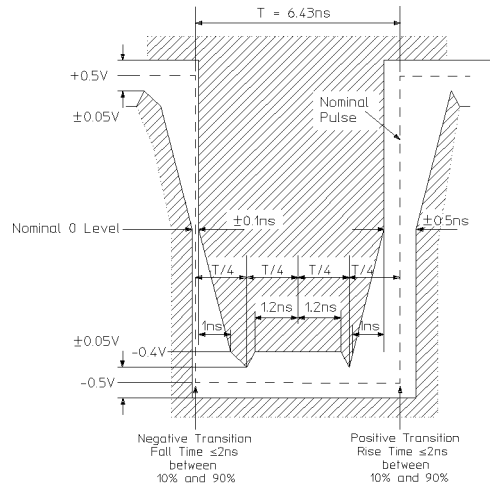

Figure 3-35

STM-1 All Ones Pattern



Note 1. The mask does not include the over/undershoot tolerance of 10%.

Note 2. The nominal zero level can be adjusted by $\pm 0.05\text{V}$ to meet the limits of the mask.

Note 3. The mask is applicable to the inverse pulse.

Figure 3-36

STM-1 All Ones Mask

CMI All Zeros Waveshape

7. Select PATTERN [ALL ZEROS] on the **OTHER** DEBUG FUNCTION display.

Performance Tests

STM-1 Transmitter Output Waveshape (Options US1, [US5], A1T, [A1U], A3R [A3S], 120)

- Adjust the Oscilloscope controls to display the waveform as shown in Figure 3-37, STM-1 All Zeros Pattern Example.
- Use the Oscilloscope PRINT function to obtain a printout of the STM-1 waveform on the external printer.
- Ensure this printout fits the STM-1 Mask of Figure 3-38.

NOTE

If a mylar mask is not available, the figure shown may be traced or photocopied onto a transparency.

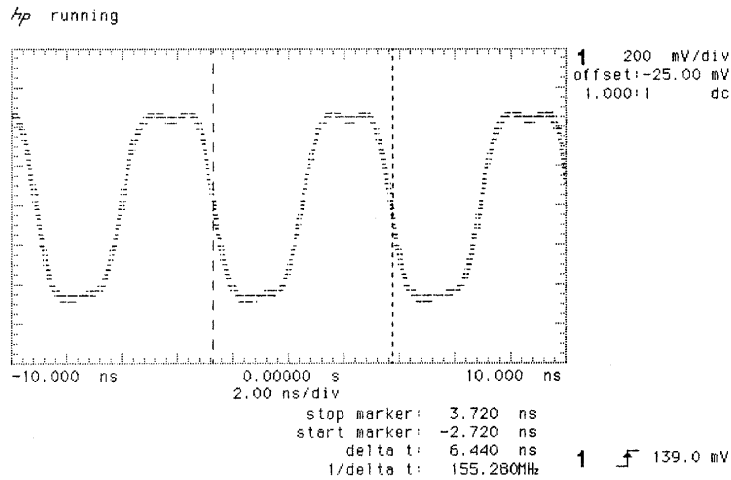
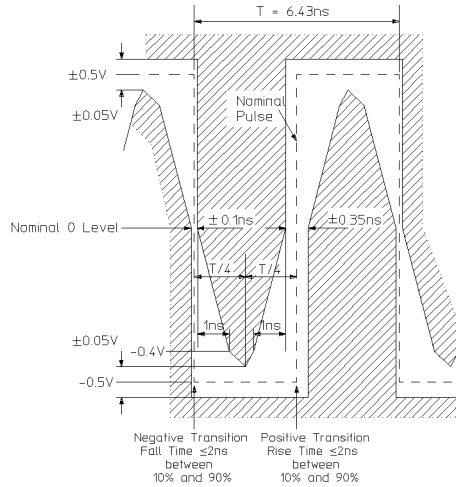

Figure 3-37

STM-1 All Zeros Pattern

Performance Tests

STM-1 Transmitter Output Waveshape (Options US1, [US5], A1T, [A1U], A3R [A3S], 120)



Note 1. The mask does not include the over/undershoot tolerance of 10%.

Note 2. The nominal zero level can be adjusted by $\pm 0.05\text{V}$ to meet the limits of the mask.

Figure 3-38

STM-1 All Zeros Mask

11. Select STM-1 TEST PATTERN [OFF] on the **OTHER** DEBUG FUNCTION display.
12. Select PATTERN [2^23-1] on the **TRANSMIT** display.
13. Adjust the Oscilloscope controls to display the eye diagram as shown in Figure 3-39, STM-1 Eye Diagram Example. Check that the waveform meets the STM-1 eye diagram mask. It may be necessary to adjust the V/div gain on the Oscilloscope.

Performance Tests

STM-1 Transmitter Output Waveshape (Options US1, [US5], A1T, [A1U], A3R [A3S], 120)

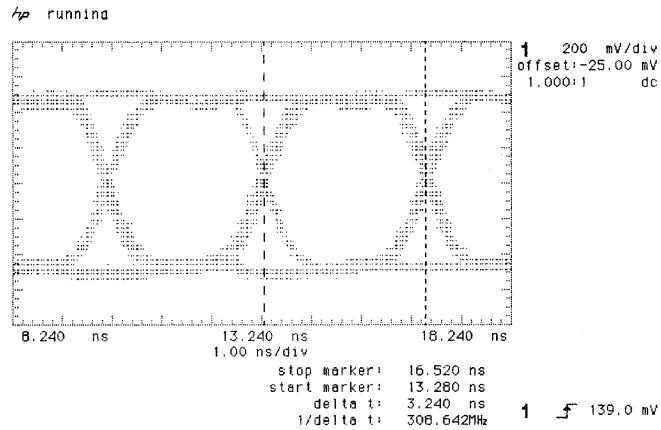

Figure 3-39

STM-1 Eye Diagram Pattern

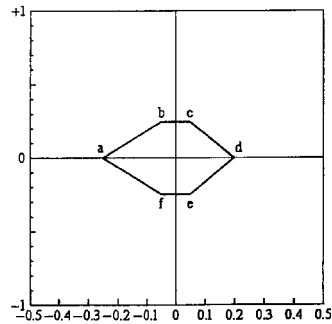

Figure 3-40

STM-1 Eye Diagram Mask

NOTE

If the mask is not available then Figure 3-40 may be traced/copied and compared with the Oscilloscope print out.

STM-1 Receiver Monitor Input (Options US1, [US5])

Specification

Receiver Monitor Mode Selectable 20 dB of flat gain, no equalization

Description

An attenuator is inserted between the STM-1 OUT port and the STM-1 IN port. The Receiver monitor mode is verified by attenuating the signal by 20 dB and checking for error-free operation.

Equipment Required

3 dB Attenuator (N-type)	: HP 8491A Option 003
6 dB Attenuator (N-type)	: HP 8491A Option 006
75/50Ω Matching Pad (N-type)	: HP 11852B (Qty 2)
N-type (f) to BNC (f) Adaptor	: HP 1250-1536 (Qty 2)
N-type (m) to N-type (f) Adaptor	: HP 1250-1475

Procedure

1. Recall the HP 37717C DEFAULT SETTINGS as shown on 3-2.
2. Select TRANSMITTER OUTPUT [SDH] and RECEIVER INPUT [SDH].
3. Connect up the equipment as shown in Figure 3-41.

Performance Tests

STM-1 Receiver Monitor Input (Options US1, [US5])

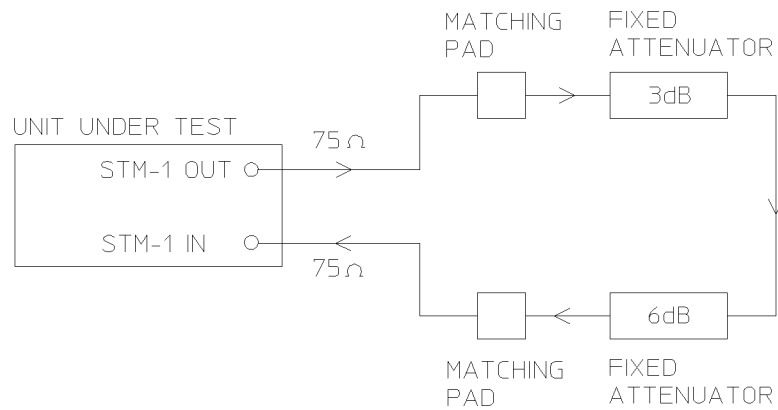

Figure 3-41

STM-1 Receiver Monitor Input

4. Press **RECEIVE** and select SIGNAL LEVEL [STM-1] [MONITOR].
5. Verify that all the front panel ALARM leds are off.
6. Press **RESULTS** **TROUBLE SCAN** and **RUN/STOP**, and check that the display indicates NO TROUBLE.
7. Press **RUN/STOP** to halt the measurement.
8. Disconnect all test equipment.

STM-1 Receiver Monitor Input (Options A1T, [A1U], A3R [A3S], 120)

Specification

Receiver Monitor Mode Selectable 20 dB and 26 dB of flat gain
12 dB equalization at 1/2 Bit Rate

Description

An attenuator and special cable attenuator are inserted between the STM-1 OUT port and the STM-1 IN port. The Receiver monitor mode is verified by attenuating the signal by 20 and 26 dB and checking for error-free operation.

Equipment Required

3 dB Attenuator (N-type)	: HP 8491A Option 003
6 dB Attenuator (N-type) (2 off)	: HP 8491A Option 006
75/50Ω Matching Pad (N-type)	: HP 11852B (Qty 2)
N-type (f) to BNC (f) Adaptor	: HP 1250-1536 (Qty 2)
N-type (m) to N-type (f) Adaptor	: HP 1250-1475
Cable Attenuator (70 m)	: HP 8120-0049

Procedure

1. Recall the HP 37717C DEFAULT SETTINGS as shown on 3-2.
2. Select TRANSMITTER OUTPUT [SDH] and RECEIVER INPUT [SDH].
3. Connect up the equipment as shown in Figure 3-42.

Performance Tests

STM-1 Receiver Monitor Input (Options A1T, [A1U], A3R [A3S], 120)

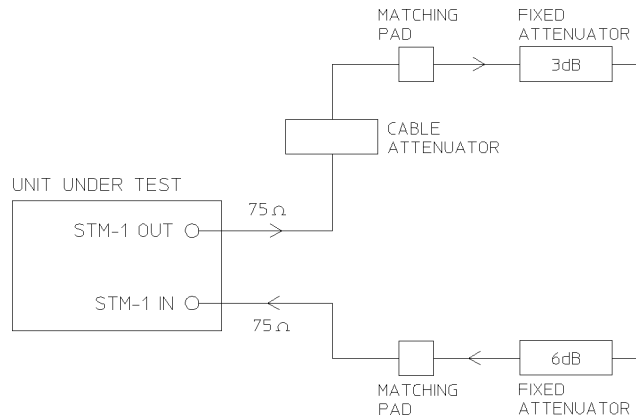

Figure 3-42

STM-1 Receiver Monitor Input

4. Press **RECEIVE** and select SIGNAL LEVEL [STM-1] [MONITOR].
5. Select GAIN [20 dB].
6. Verify that all the front panel ALARM leds are off.
7. Press **RESULTS** **TROUBLE SCAN** and **RUN/STOP**, and check that the display indicates NO TROUBLE.
8. Press **RUN/STOP** to halt the measurement.
9. Connect the second 6 dB Fixed Attenuator between the 3 dB attenuator and the Cable Attenuator.
10. Press **RECEIVE** and select GAIN [26 dB].
11. Press **RESULTS** **TROUBLE SCAN** and **RUN/STOP**, and check that the display indicates NO TROUBLE.
12. Disconnect all test equipment.

STM-1 Receiver Monitor Input (Special Option 808)

Specification

Receiver Monitor Mode 20 dB of flat gain
6dB Equalization at 1/2 Bit Rate

Description

A fixed attenuator and a special cable attenuator are inserted between the STM-1 OUT port and the STM-1 IN port. The Receiver monitor mode is verified by attenuating the signal by 20dB, along with the cable attenuator, and checking for error-free operation.

Equipment Required

3 dB Attenuator (N-type)	: HP 8491A Option 003
6 dB Attenuator (N-type)	: HP 8491A Option 006
75/50Ω Matching Pad (N-type)	: HP 11852B (Qty 2)
N-type (f) to BNC (f) Adaptor	: HP 1250-1536 (Qty 2)
N-type (m) to N-type (f) Adaptor	: HP 1250-1475
Cable Attenuator (35m)	: HP 8120-0049

Procedure

1. Recall the HP 37717C DEFAULT SETTINGS as shown on 3-2.
2. Select TRANSMITTER OUTPUT [SDH] and RECEIVER INPUT [SDH].
3. Connect up the equipment as shown in Figure 3-43.

Performance Tests

STM-1 Receiver Monitor Input (Special Option 808)

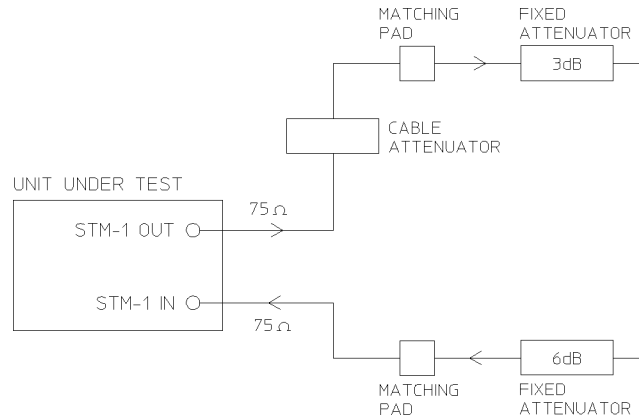

Figure 3-43

STM-1 Receiver Monitor Input

4. Press **RECEIVE** and select SIGNAL LEVEL [STM-1] [MONITOR].
5. Verify that all the front panel ALARM leds are off.
6. Press **RESULTS** **TROUBLE SCAN** and **RUN/STOP** and check that the display indicates NO TROUBLE.
7. Press **RUN/STOP** to halt the measurement.
8. Disconnect all the test equipment.

STM-1 Receiver Input Equalization (Options US1, [US5], A1T, [A1U], A3R [A3S], 120)

STM-1 Receiver Input Equalization (Options US1, [US5], A1T, [A1U], A3R [A3S], 120)

Specification

Receiver Equalization Automatic for cable loss up to 12dB at half the bit rate.

Description

Receiver Equalization is verified by inserting the special Cable between the STM-1 OUT port and the STM-1 IN port and checking for error-free operation.

Equipment Required

Cable Attenuator (70 m) : HP 8120-0049

Procedure

1. Recall the HP 37717C DEFAULT SETTINGS as shown on 3-2.
2. Select TRANSMITTER OUTPUT [SDH] and RECEIVER INPUT [SDH].
3. Connect the STM-1 OUT port to the STM-1 IN port, via the Cable Attenuator.
4. Verify that all the front panel Alarm leds are off.
5. Press **RESULTS** **TROUBLE SCAN** : **RUN/STOP** and check that the display indicates NO TROUBLE.
6. Press **RUN/STOP** to halt the measurement.
7. Disconnect all the test equipment.

STM-1 Optical Interface (Option UH1)

NOTE

An SDH Option must be fitted for this option to operate - see Appendix B.

Specification (Transmitter)

Wavelength	1280 nm to 1330 nm
Fiber Power Output	-9 dBm nominal
Line Coding	NRZ
Safety Class	Class 1, FDA 21 CFR Ch.1 1040.10 and EN 60825
Data Rate	155.52 Mb/s (Nominal)

Specification (Receiver)

Wavelength	1200 nm to 1600 nm
Maximum Input Power	-8 dBm (for BER of $1.0E^{-10}$)
Line Coding	NRZ
Dynamic Range	20 dB minimum
Sensitivity	-28 dBm Minimum (wavelength=1300nm, Modulation=100%,Data= $2^{23}-1$, BER= $1.0E^{-10}$)

Description

The 155 Mb/s output of the optical transmitter is checked for power level.

The receiver sensitivity is verified by attenuating the transmitter output and checking for no errors in a back to back mode.

STM-1 Optical Interface (Option UH1)

Equipment Required

Power Meter	: HP 8153A
Power Meter Sensor Module	: HP 81536A
FC/PC Connector Interface	: HP 81000FI (Qty. 4)
Optical Attenuator	: HP 8157A
Optical Cables (Qty. 2)	: HP 11871A

WARNING

Safety precautions must be observed when handling the HP 37717C Optical Modules as these generate laser signals which can cause serious injury. The guidelines below must be followed:

Check the connector configuration of the Fiber Optic Interfaces. If these are fitted with a connector interface other than FC/PC then remove the existing connector interface and fit the FC/PC connector interface.

Check for any damage to the HP 37717C Fiber Optic Interface spring loaded aperture covers and connectors. Do not power up the instrument if in any doubt about the integrity of these connectors.

Make all connections to the HP 37717C Fiber Optic Interfaces before powering up the instrument.

Procedure

1. Connect the STM-1 Optical Out Port to the HP 8153A (ensure that all connections are tight and that the cable has no twists).
2. Switch on the HP 37717C, check that immediately on power up the LASER ON led on the front panel illuminates for a few seconds and Recall the HP 37717C DEFAULT SETTINGS as shown on Page 3-2.
3. Recall default settings on the HP 8153A:
 - Press **MODE** to select MENU mode on the HP 8153A.
 - Press **SYSTEM** to display RECALL.
 - Press **EDIT**, select 0 — **→** A and press **EXEC** to recall the default settings (wavelength = 1300 nm, measurement time = 200 ms, autorange).

Performance Tests

STM-1 Optical Interface (Option UH1)

4. Press **MODE** then **dBmw** to select the Power Level measurement on the HP 8153A.
5. Press **TRANSMIT** **SDH** on the HP 37717C and select SIGNAL [STM-1 OPT].
6. Verify that the front panel LASER ON led is on indicating the laser is enabled.
7. Check the HP 8153A Power Meter reading is between -15 dBm and -8 dBm (Typically -9 dBm)
8. Press **OTHER** select STORED SETTINGS NUMBER [0] (Default Settings) and press **RECALL** .
9. Verify that the front panel LASER ON led is off before continuing.
10. Set the Optical Attenuator to ATTEN 0 dB, WAVELENGTH 1310 nm ; CAL=0. Connect the Optical Attenuator between the Power Meter and the HP 37717C Optical Out port (ensure that all connections are tight and that the cable has no twists).
11. Press **TRANSMIT** **SDH** on the HP 37717C and select SIGNAL [STM-1 OPT].
12. Adjust the Optical Attenuator to obtain a reading of -28 dBm on the Power Meter.
13. Press **OTHER** select STORED SETTINGS NUMBER [0] (Default Settings) and press **RECALL** .
14. Verify that the front panel LASER ON led is off before continuing.
15. Disconnect the Optical Attenuator Output from the HP 8153A and connect to the HP 37717C Optical In Port.
16. Press **OTHER** then **SETTINGS** CONTROL and select TRANSMITTER AND RECEIVER [COUPLED].
17. Press **TRANSMIT** **SDH** and select SIGNAL [STM-1 OPT].
18. Press **RESULTS** **TROUBLE SCAN** , and then **RUN/STOP** to start a measurement.
19. After 5 minutes check that NO TROUBLE is displayed on the **RESULTS** display.
20. Press **OTHER** select STORED SETTINGS NUMBER [0] (Default Settings) and press **RECALL** .
21. Verify that the front panel LASER ON led is off.
22. Disconnect the test equipment.

STM-1/STM-4 Optical Interface (Option UH2)

NOTE

An SDH Option must be fitted for this option to operate - see Appendix B.

Specification (Transmitter)

Wavelength	1280 nm to 1330 nm
Power Output	-10 dBm (Nominal)
Line Coding	NRZ
Safety Class	Class 1, FDA 21 CFR Ch.1 1040.10 and EN 60825
Data Rate	155.52 Mb/s or 622.08 Mb/s (Nominal)

Specification (Receiver)

Wavelength	1200 nm to 1600 nm
Maximum Input Power	-8 dBm (for BER of $1.0E^{-10}$)
Line Coding	NRZ
Sensitivity	-26 dBm Minimum (wavelength=1300nm, Modulation=100%,Data= $2^{23}-1$, BER= $1.0E^{-10}$)

Description

The 155.52/622.08 MHz output of the optical transmitter is checked for power level.

The receiver sensitivity is verified by attenuating the transmitter output and checking for no errors in back-to-back mode.

Performance Tests
STM-1/STM-4 Optical Interface (Option UH2)

Equipment Required

Power Meter	: HP 8153A
Power Meter Sensor Module	: HP 81536A
FC/PC Connector Interface	: HP 81000FI (Qty. 4)
Optical Attenuator	: HP 8157A
Optical Cables (Qty. 2)	: HP 11871A

Safety precautions must be observed when handling the HP 37717C Optical Modules as these generate laser signals which can cause serious injury. The guidelines below must be followed;

- Check the connector configuration of the Fiber Optic Interfaces. If these are fitted with a connector interface other than FC/PC then remove the existing connector interface and fit the FC/PC connector interface.
- Check for any damage to the HP 37717C Fiber Optic Interface spring loaded aperture covers and connectors. Do not power up the instrument if in any doubt about the integrity of these connectors.
- Make all connections to the HP 37717C Fiber Optic Interfaces before powering up the instrument.

Procedure

1. Connect the STM-4 Optical Out Port to the HP 8153A (ensure that all connections are tight and that the cable has no twists).
2. Switch on the HP 37717C, check that immediately on power up the LASER ON led on the front panel illuminates for a few seconds and Recall the HP 37717C DEFAULT SETTINGS as shown on 3-2.
3. Recall default settings on the HP 8153A:
Press **MODE** to select MENU mode on the HP 8153A.
Press **SYSTEM** to display RECALL.
Press **EDIT**, select 0 — **→** A and press **EXEC** to recall the default settings (wavelength = 1300 nm, measurement time = 200 ms, autorange).
4. Press **MODE** then **dBmw** to select the Power Level measurement on the HP 8153A.
5. Press **TRANSMIT** **SDH** on the HP 37717C and select SIGNAL [STM-1 OPT].

Performance Tests

STM-1/STM-4 Optical Interface (Option UH2)

6. Verify that the front panel LASER ON led is on, indicating the laser is enabled.
7. Check the HP 8153A Power Meter reading is between -15 dBm and -8 dBm (Typically -9 dBm).
8. Press **TRANSMIT** **SDH** on the HP 37717C and select SIGNAL [STM-4 OPT].
9. Repeat steps 6 and 7.
10. Press **OTHER** select STORED SETTINGS NUMBER [0] (Default Settings) and press **RECALL**.
11. Verify that the front panel LASER ON led is off before continuing.
12. Set the Optical Attenuator to ATTEN 0 dB, WAVELENGTH 1310 nm ; CAL=0. Connect the Optical Attenuator between the Power Meter and the HP 37717C Optical Out port (ensure that all connections are tight and that the cable has no twists).
13. Press **TRANSMIT** **SDH** on the HP 37717C and select SIGNAL [STM-1 OPT].
14. Adjust the Optical Attenuator to obtain a reading of -26 dBm on the Power Meter.
15. Press **OTHER** select STORED SETTINGS NUMBER [0] (Default Settings) and press **RECALL**.
16. Verify that the front panel LASER ON led is off before continuing.
17. Disconnect the Optical Attenuator Output from the HP 8153A and connect to the HP 37717C Optical In Port.
18. Press **OTHER** then **SETTINGS CONTROL** and select TRANSMITTER AND RECEIVER [COUPLED].
19. Press **TRANSMIT** **SDH** and select SIGNAL [STM-1 OPT].
20. Press **RESULTS** **TROUBLE SCAN**, and then **RUN/STOP** to start a measurement.
21. After 5 minutes check that NO TROUBLE is displayed on the **RESULTS** display.
22. Press **OTHER** select STORED SETTINGS NUMBER [0] (Default Settings) and press **RECALL**.
23. Verify that the front panel LASER ON led is off before continuing.
24. Repeat steps 12 through 23, selecting SIGNAL [STM-4 OPT] in steps 13 & 19.
25. Disconnect the test equipment.

Performance Tests
STM-1/STM-4, 1550nm Optical Interface (Option URU)

STM-1/STM-4, 1550nm Optical Interface (Option URU)

NOTE

An SDH Option must be fitted for this option to operate - see Appendix B.

Specification (Transmitter)

Wavelength	1520 nm to 1565 nm
Power Output	-1 dBm (Nominal)
Line Coding	NRZ
Safety Class	Class 1, FDA 21 CFR Ch.1 1040.10 and EN 60825
Data Rate	155.52 Mb/s or 622.08 Mb/s (Nominal)

Specification (Receiver)

Wavelength	1200 nm to 1600 nm
Maximum Input Power	-8 dBm (for BER of $1.0E^{-10}$)
Line Coding	NRZ
Sensitivity	-26 dBm Minimum (wavelength=1550nm, Modulation=100%,Data= $2^{23}-1$, BER= $1.0E^{-10}$)
PMP Electrical Input	150mV (Nominal)
PMP Impedance	Nominal 50Ω

Description

Minimum and maximum Optical Rx Input levels are verified by looping the Optical Tx and Rx ports through the Optical Attenuator and checking for error-free operation with identical Tx and Rx patterns selected. The signal level to the Optical Rx input is measured using the Power Meter and adjusted using the Optical Attenuator for the required minimum and maximum levels.

Performance Tests

STM-1/STM-4, 1550nm Optical Interface (Option URU)

The Protected Monitor Point (PMP) functionality is verified by looping the HP 37717C Optical Output to the PMP input via an Optical Attenuator and Optical to Electrical Converter, then checking for error-free operation with identical Tx and Rx patterns selected. The specified electrical level for the PMP input is obtained by adjusting the optical signal level to the O/E Converter using the Optical Attenuator.

Equipment Required

Power Meter	: HP 8153A
Power Meter Sensor Module	: HP 81536A
Oscilloscope	: HP 54503A
Dual Power Supply (+/-12V)	: HP 6253A
Lightwave Receiver	: HP 83442A opt 012
Optical Attenuator	: HP 8157A
FC/PC Connector Interface	: HP 81000FI (Qty. 4)
Optical Cables (qty 2)	: HP 11871A
Adaptor (SMA to BNC)	: HP 1250-1787

CAUTION

The performance of Optical Interfaces will be seriously impaired if any dirt or contamination is present on the interface connectors. Always cover the ends of optical cables and connectors with protective caps when not in use.

Always examine the ends of each fibre optic cable before use and if visible contamination is present DO NOT USE - Dirt is easily transferred to the Optical Module connector causing permanent damage. The cable should be replaced or cleaned - If cleaning, refer to Hewlett-Packard booklet *Lightwave Connection Techniques for better measurements*. HP Part Number 08703-90028.

Procedure

1. Set the Optical Attenuator to ATTEN 0 dB, WAVELENGTH 1550 nm ; CAL=0. Connect the HP 37717C STM1/4 Optical Out Port to the HP 8153A Power Meter via the HP 8157A Optical Attenuator - ensure that all connections are tight and that optical cables have no twists or tight bends.

Performance Tests

STM-1/STM-4, 1550nm Optical Interface (Option URU)

2. Setup the HP 8153A as follows:
 - a. Press **PARAM** key to display wavelength [λ]
 - b. Using **←**, **→**, **↑** and **↓** keys, set the wavelength to 1550nm.
 - c. Press **PARAM** key to display Time [t]
 - d. Using **←**, **→**, **↑** and **↓** keys, set the time to 200mS.
 - e. Press **PARAM** key to display REF.
 - f. Using **←**, **→**, **↑** and **↓** keys, set the REF to 0.000dBm.
 - g. Press **PARAM** key to display CAL.
 - h. Using **←**, **→**, **↑** and **↓** keys, set the CAL to 0.000dBm.
 - i. Cover the end of the Power Meter Optical Input connector with a protective cap.
 - j. Press the **ZERO** key on the Power Meter to calibrate - the Power Meter is now ready.
3. Switch on the HP 37717C, check that immediately on power-up the Optical Module LASER ON led illuminates for a few seconds and Recall the HP 37717C DEFAULT SETTINGS as shown on 3-2.
4. Press **TRANSMIT** **SDH** on the HP 37717C and set up the display as shown opposite.
5. Verify that the Optical Module LASER ON led is lit indicating that the laser is enabled.
6. Adjust the level to obtain a reading of -8dBm on the Power Meter. Typically around 6dB of attenuation will be required to achieve this reading.
7. Press **TRANSMIT** **SDH** on the HP 37717C and select SIGNAL [STM-1].
8. Verify that the Optical Module LASER ON led is NOT lit indicating that the laser is disabled before continuing.
9. Disconnect the optical cable from the Power Meter and connect to the HP 37717C STM1/4 Optical Rx Input.

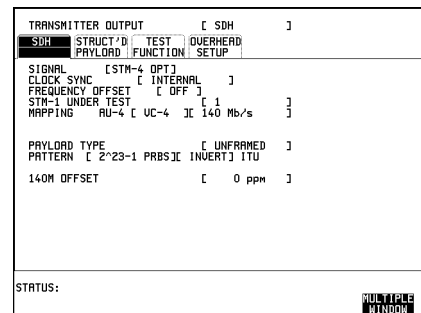

Performance Tests

STM-1/STM-4, 1550nm Optical Interface (Option URU)

10. Press **RECEIVE** on the HP 37717C and set up the display as shown opposite.

11. Press **TRANSMIT** on the HP 37717C and select SIGNAL [STM-4 OPT].

12. Press **RESULTS TROUBLE SCAN** then **RUN/STOP** to start the measurement.

13. After 5 minutes, check that NO TROUBLE is displayed on the HP 37717C **RESULTS** display. Press **RUN/STOP** to stop the measurement.

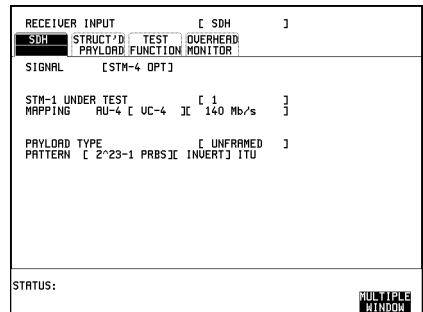

14. Press **TRANSMIT SDH** on the HP 37717C and select SIGNAL [STM-1].

15. Verify that the Optical Module LASER ON led is NOT lit indicating that the laser is disabled before continuing.

16. Reconnect the HP 37717C STM1/4 Optical Out Port to the HP 8153A Power Meter via the HP 8157A Optical Attenuator.

17. Press **TRANSMIT SDH** on the HP 37717C and select SIGNAL [STM-4 OPT].

18. Adjust the Optical Attenuator level to obtain a reading of -26dBm on the Power Meter.

19. Press **TRANSMIT SDH** on the HP 37717C and select SIGNAL [STM-1].

20. Verify that the Optical Module LASER ON led is NOT lit indicating that the laser is disabled before continuing.

21. Disconnect the optical cable from the Power Meter and connect to the HP 37717C STM1/4 Optical Rx Input.

22. Press **TRANSMIT SDH** on the HP 37717C and select SIGNAL [STM-4 OPT].

23. Press **RESULTS TROUBLE SCAN** then **RUN/STOP** to start the measurement.

24. After 5 minutes, check that NO TROUBLE is displayed on the HP 37717C **RESULTS** display. Press **RUN/STOP** to stop the measurement.

25. Press **TRANSMIT SDH** on the HP 37717C and select SIGNAL [STM-1].

26. Verify that the Optical Module LASER ON led is NOT lit indicating that the laser is disabled before continuing.

27. Disconnect the optical cable from the HP 37717C STM1/4 Optical Rx Input and connect to the HP 83442A Optical/Electrical Converter input.

Performance Tests

STM-1/STM-4, 1550nm Optical Interface (Option URU)

28. Connect the output from the Optical /Electrical Converter to the Oscilloscope using the SMA/BNC adaptor and 50 Ω BNC cable.

29. Set the Dual Power Supply to +12V and -12V, then connect to the HP 83442A O/E Converter and switch on.

CAUTION

Take care to connect the supply correctly as incorrect voltage or polarity could result in damage to the HP 83442A. Refer to HP 83442A Operating Instructions, HP p/n 5091-6448A.

30. Press **TRANSMIT** **SDH** on the HP 37717C and select SIGNAL [STM-4 OPT].

31. Press **AUTOSCALE** on the oscilloscope and adjust the Timebase and Range to obtain an STM-4 waveform.

32. Measure the amplitude of this STM-4 waveform using the oscilloscope and adjust the Optical Attenuator until the amplitude is 150mV.

NOTE

If the input power is greater than -8 dBm then the Optical/Electrical converter is liable to saturate.

33. Disconnect the output of the O/E Converter from the oscilloscope and connect instead to the HP 37717C STM1/4 Optical Module Monitor Input.

34. Press **RECEIVE** on the HP 37717C and set up the display as shown opposite.

35. Press **RESULTS** **TROUBLE SCAN** then **RUN/STOP** to start the measurement.

36. After 5 minutes, check that NO TROUBLE is displayed on the HP 37717C **RESULTS** display. Press **RUN/STOP** to stop the measurement.

37. Recall the HP 37717C DEFAULT SETTINGS as shown on 3-2.

38. Verify that the Optical Module LASER ON led is NOT lit indicating that the laser is disabled before continuing.

39. Repeat steps 1 to 38 but with [STM-1 OPT] selected on the HP 37717C Tx and Rx display parameters instead of [STM-4 OPT].

40. Disconnect all Test equipment.

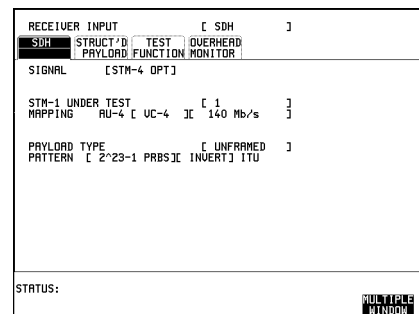

STM-1/STM-4 Optical Interface (Options UKT, USN)

NOTE

An SDH Option must be fitted for this option to operate - see Appendix B.

Specification (Transmitter)

Wavelength	UKT - 1280 nm to 1330 nm, USN - 1280 nm to 1330 nm or 1520 nm to 1565 nm
Power Output	1310 nm -10 dBm (Nominal). 1550 nm -1dBm (Nominal)
Line Coding	NRZ
Safety Class	Class 3A, FDA 21 CFR Ch.1 1040.10 and EN 60825
Data Rate	155.52 Mb/s or 622.08 Mb/s (Nominal)

Specification (Receiver)

Wavelength	1200 nm to 1600 nm
Maximum Input Power	-8 dBm (for BER of $1.0E^{-10}$)
Line Coding	NRZ
Sensitivity	-34 dBm Minimum (STM-1), - 28 dBm Minimum (STM-4) (wavelength=1300nm, Modulation=100%, Data= $2^{23}-1$, BER= $1.0E^{-10}$)
PMP Input	150mV pk-pk minimum
PMP Impedance	Nominal 50Ω

Description

The 155.52/622.08 MHz output of the optical transmitter is checked for power level at 1310 nm (and 1550 nm wavelengths if Option USN). The receiver sensitivity is verified by attenuating the transmitter output and checking for no errors in back-to-

Performance Tests

STM-1/STM-4 Optical Interface (Options UKT, USN)

back mode at 1310 nm (and 1550 nm wavelengths if Option USN).

The Protected Monitor Point (PMP) functionality is verified by looping the HP 37717C Optical Output to the PMP input via an Optical Attenuator and Optical to Electrical Converter, then checking for error-free operation with identical Tx and Rx patterns selected. The specified electrical level for the PMP input is obtained by adjusting the optical signal level to the O/E Converter using the Optical Attenuator.

Equipment Required

Power Meter	: HP 8153A
Power Meter Sensor Module	: HP 81536A
Oscilloscope	: HP 54503A
Dual Power Supply (+/-12V)	: HP 6253A
Lightwave Receiver	: HP 83442A opt 012
FC/PC Connector Interface	: HP 81000FI (Qty. 4)
Optical Attenuator	: HP 8157A
Optical Cables (Qty. 2)	: HP 11871A
Adaptor (SMA to BNC)	: HP 1250-1787

WARNING

Safety precautions must be observed when handling the HP 37717C Optical Modules as these generate laser signals which can cause serious injury. The guidelines below must be followed:

Check the connector configuration of the Fiber Optic Interfaces. If these are fitted with a connector interface other than FC/PC then remove the existing connector interface and fit the FC/PC connector interface.

Check for any damage to the HP 37717C Fiber Optic Interface spring loaded aperture covers and connectors. Do not power up the instrument if in any doubt about the integrity of these connectors.

Make all connections to the HP 37717C Fiber Optic Interfaces before powering up the instrument.

Procedure Option UKT and USN

1. Connect the HP 37717C 1310 nm Optical Out Port to the HP 8153A (ensure that all connections are tight and that the cable has no twists).
2. Switch on the HP 37717C, check that immediately on power up the LASER ON led on the front panel illuminates for a few seconds and Recall the HP 37717C DEFAULT SETTINGS as shown on page 3-2.
3. Recall default settings on the HP 8153A:
Press **MODE** to select MENU mode on the HP 8153A.
Press **SYSTEM** to display RECALL.
Press **EDIT**, select 0 — **→**A and press **EXEC** to recall the default settings (wavelength = 1300 nm, measurement time = 200 ms, autorange).
4. Press **MODE** then **dBmw** to select the Power Level measurement on the HP 8153A.
5. Press **TRANSMIT** **SDH** on the HP 37717C and select SIGNAL [STM-1 OPT] [1310 nm].
6. Verify that the front panel LASER ON led is on, indicating the laser is enabled.
7. Check the HP 8153A Power Meter reading is between -15 dBm and -8 dBm (Typically -10 dBm).
8. Press **TRANSMIT** **SDH** on the HP 37717C and select SIGNAL [STM-4 OPT] [1310 nm].
9. Repeat steps 6 and 7.
10. Press **OTHER** select STORED SETTINGS NUMBER [0] (Default Settings) and press **RECALL**.
11. Verify that the front panel LASER ON led is off before continuing.
12. Connect the Optical Attenuator between the Power Meter and the HP 37717C 1310 nm Optical Out port (ensure that all connections are tight and that the cable has no twists). Set the Optical Attenuator to ATTEN 0dB, WAVELENGTH 1310 nm ; CAL=0.
13. Press **TRANSMIT** **SDH** on the HP 37717C and select SIGNAL [STM-1 OPT] [1310 nm].
14. Adjust the Optical Attenuator to obtain a reading of -34 dBm on the Power Meter.
15. Press **OTHER** select STORED SETTINGS NUMBER [0] (Default Settings) and press **RECALL**.

Performance Tests

STM-1/STM-4 Optical Interface (Options UKT, USN)

16. Verify that the front panel LASER ON led is off before continuing.
17. Disconnect the Optical Attenuator Output from the HP 8153A and connect to the HP 37717C Optical In Port.
18. Press **OTHER** then **SETTINGS CONTROL** and select TRANSMITTER AND RECEIVER [COUPLED].
19. Press **TRANSMIT** **SDH** and select SIGNAL [STM-1 OPT] [1310 nm].
20. Press **RESULTS** **TROUBLE SCAN**, and then **RUN/STOP** to start a measurement.
21. After 5 minutes check that NO TROUBLE is displayed on the **RESULTS** display.
22. Repeat steps 10 through 21, selecting SIGNAL [STM-4 OPT] [1310 nm] in steps 13 and 19 and -28 dBm in step 14.
23. Recall the HP 37717C DEFAULT SETTINGS as shown on 3-2.
24. Disconnect the optical cable from the HP 37717C STM1/4 Optical IN Port and connect to the HP 83442A Optical/Electrical Converter input.
25. Connect the output from the Optical /Electrical Converter to the Oscilloscope using the SMA/BNC adaptor and 50 Ω BNC cable.
26. Set the Dual Power Supply to +12V and -12V, then connect to the HP 83442A O/E Converter and switch on.

CAUTION

Take care to connect the supply correctly as incorrect voltage or polarity could result in damage to the HP 83442A. Refer to HP 83442A Operating Instructions, HP p/n 5091-6448A.

27. Press **TRANSMIT** **SDH** on the HP 37717C and select SIGNAL [STM-4 OPT] [1310 nm].
28. Press **AUTOSCALE** on the oscilloscope and adjust the Timebase and Range to obtain an STM-4 waveform.
29. Measure the amplitude of this STM-4 waveform using the oscilloscope and adjust the Optical Attenuator until the amplitude is 150mV pk-pk.

NOTE

If the input power is greater than -8 dBm then the Optical/Electrical converter is liable to saturate.

Performance Tests

STM-1/STM-4 Optical Interface (Options UKT, USN)

30. Disconnect the output of the O/E Converter from the oscilloscope and connect instead to the HP 37717C STM1/4 Optical Module Monitor Input.

31. Press **RECEIVE** on the HP 37717C and set up the display as shown opposite.

32. Press **RESULTS** **TROUBLE SCAN** then **RUN/STOP** to start the measurement.

33. After 5 minutes, check that NO TROUBLE is displayed on the HP 37717C **RESULTS** display. Press **RUN/STOP** to stop the measurement.

34. Recall the HP 37717C DEFAULT SETTINGS as shown on 3-2.

35. Verify that the Optical Module LASER ON led is NOT lit indicating that the laser is disabled before continuing.

36. Repeat steps 23 through 35, selecting SIGNAL [STM-1 OPT] [1310 nm] in step 27 and [STM-1 MON] in step 31.

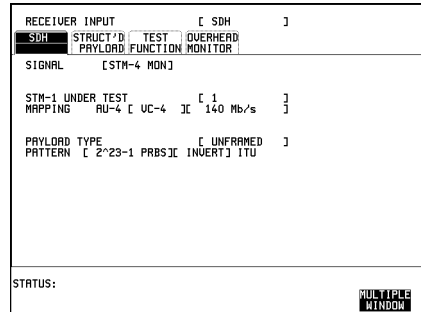

Procedure Option USN only

37. Set the Optical Attenuator to WAVELENGTH 1550 nm ; CAL=0.

Connect the HP 37717C 1550 nm Optical Out Port to the HP 8153A Power Meter via the HP 8157A Optical Attenuator, set to ATTEN 10 dB - ensure that all connections are tight and that optical cables have no twists or tight bends.

38. Setup the HP 8153A as follows:

a. Press **PARAM** key to display wavelength [λ]

b. Using **←**, **→**, **↑** and **↓** keys, set the wavelength to 1550nm.

c. Press **PARAM** key to display Time [t]

d. Using **←**, **→**, **↑** and **↓** keys, set the time to 200mS.

e. Press **PARAM** key to display REF.

f. Using **←**, **→**, **↑** and **↓** keys, set the REF to 0.000dBm.

g. Press **PARAM** key to display CAL.

h. Using **←**, **→**, **↑** and **↓** keys, set the CAL to 0.000dBm.

i. Cover the end of the Power Meter Optical Input connector with a protective cap.

Performance Tests

STM-1/STM-4 Optical Interface (Options UKT, USN)

j. Press the **ZERO** key on the Power Meter to calibrate - the Power Meter is now ready.

39. Switch on the HP 37717C and check that immediately on power-up the Optical Module LASER ON led illuminates for a few seconds.

40. Press **TRANSMIT** on the HP 37717C and set up the display as shown opposite.

41. Verify that the Optical Module LASER ON led is lit indicating that the laser is enabled.

42. Adjust the level to obtain a reading of -8dBm on the Power Meter. Typically around 7dB of attenuation will be required to achieve this reading.

TRANSMITTER OUTPUT	[SDH]
SDH STRUCT'D TEST OVERHEAD	
PAYLOAD FUNCTION SETUP	
SIGNAL	[STM-4 OPT] [1550] [INTERNAL]
CLOCK SYNC	[INTERNAL]
FREQUENCY OFFSET	[OFF]
STM-1 UNDER TEST	[1]
MAPPING	RU-4 [UC-4] [140 Mb/s]
PAYLOAD TYPE	[UNFRAMED]
PATTERN	[2 ⁿ 23-1 PRBS] [INVERT] [ITU]
140M OFFSET	[0 ppm]
STATUS:	MULTIPLE WINDOW

43. Recall the HP 37717C DEFAULT SETTINGS as shown on Page 3-2.

44. Verify that the Optical Module LASER ON led is NOT lit indicating that the laser is disabled before continuing.

45. Disconnect the optical cable from the Power Meter and connect to the HP 37717C Optical IN Port.

46. Press **RECEIVE** on the HP 37717C and set up the display as shown opposite.

47. Press **TRANSMIT** on the HP 37717C and select SIGNAL [STM-4 OPT] [1550 nm].

48. Press **RESULTS TROUBLE SCAN** then **RUN/STOP** to start the measurement.

49. After 5 minutes, check that NO TROUBLE is displayed on the HP 37717C display. Press **RESULTS** display. Press **RUN/STOP** to stop the measurement.

RECEIVER INPUT	[SDH]
SDH STRUCT'D TEST OVERHEAD	
PAYLOAD FUNCTION MONITOR	
SIGNAL	[STM-4 OPT]
STM-1 UNDER TEST	[1]
MAPPING	RU-4 [UC-4] [140 Mb/s]
PAYLOAD TYPE	[UNFRAMED]
PATTERN	[2 ⁿ 23-1 PRBS] [INVERT] [ITU]
STATUS:	MULTIPLE WINDOW

50. Recall the HP 37717C DEFAULT SETTINGS as shown on Page 3-2.

51. Verify that the Optical Module LASER ON led is NOT lit indicating that the laser is disabled before continuing.

Performance Tests

STM-1/STM-4 Optical Interface (Options UKT, USN)

52. Reconnect the HP 37717C 1550 nm Optical Out Port to the HP 8153A Power Meter via the HP 8157A Optical Attenuator.
53. Press **TRANSMIT** **SDH** on the HP 37717C and select SIGNAL [STM-4 OPT] [1550 nm].
54. Adjust the Optical Attenuator level to obtain a reading of -28dBm on the Power Meter.
55. Recall the HP 37717C DEFAULT SETTINGS as shown on 3-2.
56. Verify that the Optical Module LASER ON led is NOT lit indicating that the laser is disabled before continuing.
57. Disconnect the optical cable from the Power Meter and connect to the HP 37717C Optical IN Port.
58. Press **TRANSMIT** **SDH** on the HP 37717C and select SIGNAL [STM-4 OPT] [1550 nm].
59. Press **RESULTS** **TROUBLE SCAN** then **RUN/STOP** to start the measurement.
60. After 5 minutes, check that NO TROUBLE is displayed on the HP 37717C **RESULTS** display.
Press **RUN/STOP** to stop the measurement.
61. Repeat steps 50 through 60, selecting SIGNAL [STM-1 OPT] [1550 nm] in steps 53 and 58 and -34dBm in step 54.
62. Recall the HP 37717C DEFAULT SETTINGS as shown on Page 3-2.
63. Verify that the Optical Module LASER ON led is NOT lit indicating that the laser is disabled before continuing.
64. Disconnect the optical cable from the HP 37717C STM1/4 Optical IN Port and connect to the HP 83442A Optical/Electrical Converter input.
65. Connect the output from the Optical /Electrical Converter to the Oscilloscope using the SMA/BNC adaptor and 50 Ω BNC cable.
66. Set the Dual Power Supply to +12V and -12V, then connect to the HP 83442A O/E Converter and switch on.

CAUTION

Take care to connect the supply correctly as incorrect voltage or polarity could result in damage to the HP 83442A. Refer to HP 83442A Operating Instructions, HP p/n 5091-6448A.

Performance Tests

STM-1/STM-4 Optical Interface (Options UKT, USN)

67. Press **TRANSMIT** **SDH** on the HP 37717C and select SIGNAL [STM-4 OPT] [1550 nm].

68. Press **AUTOSCALE** on the oscilloscope and adjust the Timebase and Range to obtain an STM-4 waveform.

69. Measure the amplitude of this STM-4 waveform using the oscilloscope and adjust the Optical Attenuator until the amplitude is 150mV pk-pk.

NOTE

If the input power is greater than -8 dBm then the Optical/Electrical converter is liable to saturate.

70. Disconnect the output of the O/E Converter from the oscilloscope and connect instead to the HP 37717C STM1/4 Optical Module Monitor Input.

71. Press **RECEIVE** on the HP 37717C and set up the display as shown opposite.

72. Press **RESULTS** **TROUBLE SCAN** then **RUN/STOP** to start the measurement.

73. After 5 minutes, check that NO TROUBLE is displayed on the HP 37717C **RESULTS** display. Press **RUN/STOP** to stop the measurement.

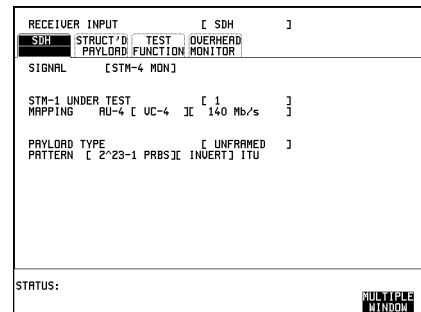

74. Recall the HP 37717C DEFAULT SETTINGS as shown on 3-2.

75. Verify that the Optical Module LASER ON led is NOT lit indicating that the laser is disabled before continuing.

76. Repeat steps 62 through 75, selecting SIGNAL [STM-1 OPT] [1550 nm] in step 67 and [STM-1 MON] in step 71.

77. Disconnect all the test equipment.

STM-1/STM-4 Optical Interface (Options 130, 131)

NOTE

An SDH Option must be fitted for this option to operate - see Appendix B.

Specification (Transmitter)

Wavelength	130 - 1280 nm to 1330 nm, 131 - 1280 nm to 1330 nm or 1520 nm to 1565 nm
Power Output	1310 nm -10 dBm (Nominal). 1550 nm -1dBm (Nominal)
Line Coding	NRZ
Safety Class	Class 3A, FDA 21 CFR Ch.1 1040.10 and EN 60825
Data Rate	51.84 Mb/s, or 155.52 Mb/s or 622.08 Mb/s (Nominal)

Specification (Receiver)

Wavelength	1200 nm to 1600 nm
Maximum Input Power	-8 dBm (for BER of $1.0E^{-10}$)
Line Coding	NRZ
Sensitivity	-34 dBm Minimum (STM-0 & STM-1), - 28 dBm Minimum (STM-4) (wavelength=1300nm, Modulation=100%, Data= $2^{23}-1$, BER= $1.0E^{-10}$, $2^{23}-1$ PRBS)
PMP Input	150mV pk-pk minimum
PMP Impedance	Nominal 50Ω

Description

The 51.84/155.52/622.08 MHz output of the optical transmitter is checked for power level at 1310 nm (and 1550 nm wavelengths if Option131). The receiver sensitivity is verified by attenuating the transmitter output and checking for no

Performance Tests

STM-1/STM-4 Optical Interface (Options 130, 131)

errors in back-to-back mode at 1310 nm (and 1550 nm wavelengths if Option 131). The Protected Monitor Point (PMP) functionality is verified by looping the HP 37717C Optical Output to the PMP input via an Optical Attenuator and Optical to Electrical Converter, then checking for error-free operation with identical Tx and Rx patterns selected. The specified electrical level for the PMP input is obtained by adjusting the optical signal level to the O/E Converter using the Optical Attenuator.

Equipment Required

Power Meter	: HP 8153A
Power Meter Sensor Module	: HP 81536A
Oscilloscope	: HP 54503A
Dual Power Supply (+/-12V)	: HP 6253A
Lightwave Receiver	: HP 83442A opt 012
FC/PC Connector Interface	: HP 81000FI (Qty. 4)
Optical Attenuator	: HP 8157A
Optical Cables (Qty. 2)	: HP 11871A
Adaptor (SMA to BNC)	: HP 1250-1787

WARNING

Safety precautions must be observed when handling the HP 37717C Optical Modules as these generate laser signals which can cause serious injury. The guidelines below must be followed:

Check the connector configuration of the Fiber Optic Interfaces. If these are fitted with a connector interface other than FC/PC then remove the existing connector interface and fit the FC/PC connector interface.

Check for any damage to the HP 37717C Fiber Optic Interface spring loaded aperture covers and connectors. Do not power up the instrument if in any doubt about the integrity of these connectors.

Make all connections to the HP 37717C Fiber Optic Interfaces before powering up the instrument.

Procedure Option 130 and 131

1. Connect the HP 37717C 1310 nm Optical Out Port to the HP 8153A (ensure that all connections are tight and that the cable has no twists).

Performance Tests

STM-1/STM-4 Optical Interface (Options 130, 131)

2. Switch on the HP 37717C, check that immediately on power up the LASER ON led on the front panel illuminates for a few seconds and Recall the HP 37717C DEFAULT SETTINGS as shown on 3-2.
3. Recall default settings on the HP 8153A:
Press **MODE** to select MENU mode on the HP 8153A.
Press **SYSTEM** to display RECALL.
Press **EDIT**, select 0 — **→**A and press **EXEC** to recall the default settings (wavelength = 1300 nm, measurement time = 200 ms, autorange).
4. Press **MODE** then **dBmw** to select the Power Level measurement on the HP 8153A.
5. Press **TRANSMIT** **SDH** on the HP 37717C and select SIGNAL [STM-1 OPT] [1310 nm].
6. Verify that the front panel LASER ON led is on, indicating the laser is enabled.
7. Check the HP 8153A Power Meter reading is between -15 dBm and -8 dBm (Typically -10 dBm).
8. Press **TRANSMIT** **SDH** on the HP 37717C and select SIGNAL [STM-4 OPT] [1310 nm].
9. Repeat steps 6 and 7.
10. Press **TRANSMIT** **SDH** on the HP 37717C and select SIGNAL [STM-0 OPT] [1310 nm].
11. Repeat steps 6 and 7.
12. Press **OTHER** select STORED SETTINGS NUMBER [0] (Default Settings) and press **RECALL**.
13. Verify that the front panel LASER ON led is off before continuing.
14. Connect the Optical Attenuator between the Power Meter and the HP 37717C 1310 nm Optical Out port (ensure that all connections are tight and that the cable has no twists). Set the Optical Attenuator to ATTEN 0dB, WAVELENGTH 1310 nm ; CAL=0.
15. Press **TRANSMIT** **SDH** on the HP 37717C and select SIGNAL [STM-1 OPT] [1310 nm].
16. Adjust the Optical Attenuator to obtain a reading of -34dBm ±1dB on the Power Meter.

Performance Tests

STM-1/STM-4 Optical Interface (Options 130, 131)

17. Press **OTHER** select STORED SETTINGS NUMBER [0] (Default Settings) and press **RECALL**.
18. Verify that the front panel LASER ON led is off before continuing.
19. Disconnect the Optical Attenuator Output from the HP 8153A and connect to the HP 37717C Optical In Port.
20. Press **OTHER** then **SETTINGS CONTROL** and select TRANSMITTER AND RECEIVER [COUPLED].
21. Press **TRANSMIT** **SDH** and select SIGNAL [STM-1 OPT] [1310 nm].
22. Press **RESULTS** **TROUBLE SCAN**, and then **RUN/STOP** to start a measurement.
23. After 5 minutes check that NO TROUBLE is displayed on the **RESULTS** display.
24. Repeat steps 12 through 23, selecting SIGNAL [STM-0 OPT] [1310 nm] in steps 15 and 21.
25. Repeat steps 12 through 23, selecting SIGNAL [STM-4 OPT] [1310 nm] in steps 15 and 21 and -28dBm \pm 1dB in step 16.
26. Recall the HP 37717C DEFAULT SETTINGS as shown on 3-2.
27. Disconnect the optical cable from the HP 37717C STM1/4 Optical IN Port and connect to the HP 83442A Optical/Electrical Converter input.
28. Connect the output from the Optical /Electrical Converter to the Oscilloscope using the SMA/BNC adaptor and 50 Ω BNC cable.
29. Set the Dual Power Supply to +12V and -12V, then connect to the HP 83442A O/E Converter and switch on.

CAUTION

Take care to connect the supply correctly as incorrect voltage or polarity could result in damage to the HP 83442A. Refer to HP 83442A Operating Instructions, HP p/n 5091-6448A.

30. Press **TRANSMIT** **SDH** on the HP 37717C and select SIGNAL [STM-4 OPT] [1310 nm].
31. Press **AUTOSCALE** on the oscilloscope and adjust the Timebase and Range to obtain an STM-4 waveform.
32. Measure the amplitude of this STM-4 waveform using the oscilloscope and adjust the Optical Attenuator until the amplitude is 150mV pk-pk.

Performance Tests

STM-1/STM-4 Optical Interface (Options 130, 131)

NOTE

If the input power is greater than -8 dBm then the Optical/Electrical converter is liable to saturate.

33. Disconnect the output of the O/E Converter from the oscilloscope and connect instead to the HP 37717C STM1/4 Optical Module Monitor Input.

34. Press **RECEIVE** on the HP 37717C and set up the display as shown opposite.

35. Press **RESULTS TROUBLE SCAN** then **RUN/STOP** to start the measurement.

36. After 5 minutes, check that NO TROUBLE is displayed on the HP 37717C **RESULTS** display. Press **RUN/STOP** to stop the measurement.

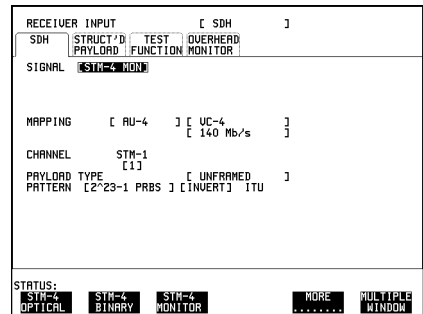

37. Recall the HP 37717C DEFAULT SETTINGS as shown on 3-2.

38. Verify that the Optical Module LASER ON led is NOT lit indicating that the laser is disabled before continuing.

39. Repeat steps 26 through 38, selecting SIGNAL [STM-1 OPT] [1310 nm] in step 30 and [STM-1 MON] in step 34.

40. Repeat steps 26 through 38, selecting SIGNAL [STM-0 OPT] [1310 nm] in step 30 and [STM-1 MON] in step 34.

Procedure Option 130 only

41. Set the Optical Attenuator to WAVELENGTH 1550 nm ; CAL=0.

Connect the HP 37717C 1550 nm Optical Out Port to the HP 8153A Power Meter via the HP 8157A Optical Attenuator, set to ATTEN 10 dB - ensure that all connections are tight and that optical cables have no twists or tight bends.

42. Setup the HP 8153A as follows:

- Press **PARAM** key to display wavelength [λ]
- Using **←**, **→**, **↑** and **↓** keys, set the wavelength to 1550nm.
- Press **PARAM** key to display Time [t]
- Using **←**, **→**, **↑** and **↓** keys, set the time to 200mS.
- Press **PARAM** key to display REF.

Performance Tests

STM-1/STM-4 Optical Interface (Options 130, 131)

- f. Using **←**, **→**, **↑** and **↓** keys, set the REF to 0.000dBm.
- g. Press **PARAM** key to display CAL.
- h. Using **←**, **→**, **↑** and **↓** keys, set the CAL to 0.000dBm.
- i. Cover the end of the Power Meter Optical Input connector with a protective cap.
- j. Press the **ZERO** key on the Power Meter to calibrate - the Power Meter is now ready.
43. Switch on the HP 37717C and check that immediately on powered-up the Optical Module LASER ON led illuminates for a few seconds.

44. Press **TRANSMIT** on the HP 37717C and set up the display as shown opposite.

TRANSMITTER OUTPUT		[SDH]	
SDH	STRUCT'D	TEST	OVERHEAD
PAYLOAD	JITTER	FUNCTION	SETUP
SIGNAL [STM-4 OPTIC] 1550 [INTERNAL]			
CLOCK [INTERNAL] OFFSET [OFF]			
MAPPING [AU-4]		[FOREGROUND]	
140M OFFSET CHANNEL		[UC-4]	
STM-1		[140 Mb/s]	
PAYLOAD TYPE [1]		[UNFRAMED]	
PATTERN [2*23-1 PRBS]		[INVERT] ITU	
STATUS:			
MULTIPLE WINDOW			

45. Verify that the Optical Module LASER ON led is lit indicating that the laser is enabled.

46. Adjust the level to obtain a reading of -8dBm \pm 1dB on the Power Meter. Typically around 7dB of attenuation will be required to achieve this reading.

47. Recall the HP 37717C DEFAULT SETTINGS as shown on 3-2.

48. Verify that the Optical Module LASER ON led is NOT lit indicating that the laser is disabled before continuing.

49. Disconnect the optical cable from the Power Meter and connect to the HP 37717C Optical IN Port.

50. Press **RECEIVE** on the HP 37717C and set up the display as shown opposite.

RECEIVER INPUT		[SDH]	
SDH	STRUCT'D	TEST	OVERHEAD
PAYLOAD	FUNCTION	MONITOR	
SIGNAL [STM-4 MON]			
MAPPING [AU-4]		[UC-4]	
CHANNEL		[140 Mb/s]	
STM-1			
PAYLOAD TYPE [1]		[UNFRAMED]	
PATTERN [2*23-1 PRBS]		[INVERT] ITU	
STATUS:			
MULTIPLE WINDOW			

51. Press **TRANSMIT** on the HP 37717C and select SIGNAL [STM-4 OPT] [1550 nm].

52. Press **RESULTS TROUBLE SCAN** then **RUN/STOP** to start the measurement.

53. After 5 minutes, check that NO TROUBLE is displayed on the HP 37717C display. Press **RESULTS** display. Press **RUN/STOP** to stop the measurement.

Performance Tests

STM-1/STM-4 Optical Interface (Options 130, 131)

54. Recall the HP 37717C DEFAULT SETTINGS as shown on 3-2.
55. Verify that the Optical Module LASER ON led is NOT lit indicating that the laser is disabled before continuing.
56. Reconnect the HP 37717C 1550 nm Optical Out Port to the HP 8153A Power Meter via the HP 8157A Optical Attenuator.
57. Press **TRANSMIT** **SDH** on the HP 37717C and select SIGNAL [STM-4 OPT] [1550 nm].
58. Adjust the Optical Attenuator level to obtain a reading of $-28\text{dBm} \pm 1\text{dB}$ on the Power Meter.
59. Recall the HP 37717C DEFAULT SETTINGS as shown on 3-2.
60. Verify that the Optical Module LASER ON led is NOT lit indicating that the laser is disabled before continuing.
61. Disconnect the optical cable from the Power Meter and connect to the HP 37717C Optical IN Port.
62. Press **TRANSMIT** **SDH** on the HP 37717C and select SIGNAL [STM-4 OPT] [1550 nm].
63. Press **RESULTS** **TROUBLE SCAN** then **RUN/STOP** to start the measurement.
64. After 5 minutes, check that NO TROUBLE is displayed on the HP 37717C **RESULTS** display.
Press **RUN/STOP** to stop the measurement.
65. Repeat steps 54 through 64, selecting SIGNAL [STM-1 OPT] [1550 nm] in steps 57 and 62 and $-34\text{dBm} \pm 1\text{dB}$ in step 58.
66. Repeat steps 54 through 64, selecting SIGNAL [STM-0 OPT] [1550 nm] in steps 57 and 62 and $-34\text{dBm} \pm 1\text{dB}$ in step 58.
67. Recall the HP 37717C DEFAULT SETTINGS as shown on 3-2.
68. Verify that the Optical Module LASER ON led is NOT lit indicating that the laser is disabled before continuing.
69. Disconnect the optical cable from the HP 37717C STM1/4 Optical IN Port and connect to the HP 83442A Optical/Electrical Converter input.
70. Connect the output from the Optical /Electrical Converter to the Oscilloscope using the SMA/BNC adaptor and 50Ω BNC cable.

Performance Tests

STM-1/STM-4 Optical Interface (Options 130, 131)

71. Set the Dual Power Supply to +12V and -12V, then connect to the HP 83442A O/E Converter and switch on.

CAUTION

Take care to connect the supply correctly as incorrect voltage or polarity could result in damage to the HP 83442A. Refer to HP 83442A Operating Instructions, HP p/n 5091-6448A.

72. Press **TRANSMIT** **SDH** on the HP 37717C and select SIGNAL [STM-4 OPT] [1550 nm].

73. Press **AUTOSCALE** on the oscilloscope and adjust the Timebase and Range to obtain an STM-4 waveform.

74. Measure the amplitude of this STM-4 waveform using the oscilloscope and adjust the Optical Attenuator until the amplitude is 150mV pk-pk.

NOTE

If the input power is greater than -8 dBm then the Optical/Electrical converter is liable to saturate.

75. Disconnect the output of the O/E Converter from the oscilloscope and connect instead to the HP 37717C STM1/4 Optical Module Monitor Input.

76. Press **RECEIVE** on the HP 37717C and set up the display as shown opposite.

77. Press **RESULTS** **TROUBLE SCAN** then **RUN/STOP** to start the measurement.

78. After 5 minutes, check that NO TROUBLE is displayed on the HP 37717C **RESULTS** display. Press **RUN/STOP** to stop the measurement.

79. Recall the HP 37717C DEFAULT SETTINGS as shown on 3-2.

80. Verify that the Optical Module LASER ON led is NOT lit indicating that the laser is disabled before continuing.

81. Repeat steps 67 through 80, selecting SIGNAL [STM-1 OPT] [1550 nm] in step 72 and [STM-1 MON] in step 76.

82. Repeat steps 67 through 80, selecting SIGNAL [STM-0 OPT] [1550 nm] in step 72 and [STM-0 MON] in step 76.

83. Disconnect all the test equipment.

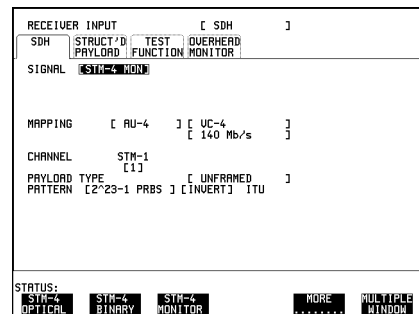

Transmitted Jitter Amplitude Accuracy (Option UHK)**Specifications**

Data Rates	2.048 Mb/s, 8.448 Mb/s, 34.368 Mb/s, 139.264 Mb/s, 155.52 Mb/s (STM-1), 622.08 Mb/s (STM-4)
Overall Accuracy	$\pm 5\%$ \pm range accuracy \pm intrinsic jitter
Range 1	± 0.01 UI
Range 10	± 0.1 UI
Intrinsic Jitter 2 Mb/s	± 0.02 UI
Intrinsic Jitter 8 Mb/s	± 0.02 UI
Intrinsic Jitter 34 Mb/s	± 0.03 UI
Intrinsic Jitter 140 Mb/s	200 Hz to 5 kHz - ± 0.10 UI 5 kHz to 10 kHz - ± 0.05 UI >10 kHz - ± 0.02 UI
Frequency Range	2 Hz to 4 MHz
Frequency Accuracy	$\pm 1\%$

Corner and Cut-off Frequencies

Data Rate	Corner Frequency	Cut-off Frequency
2 Mb/s	13 kHz	102 kHz
8 Mb/s	50 kHz	422 kHz
34 Mb/s	210 kHz	840 kHz
140 Mb/s	5 kHz	4 MHz

Transmitted Jitter Amplitude Accuracy (Option UHK)

Description

The HP 37717C Transmitter Unbalanced PDH Output is connected to the Spectrum Analyzer. The HP 37717C Jitter modulation frequency is set to the specified maximum for 10UI at the selected Bit Rate and the Spectrum Analyzer set to optimize the displayed spectrum centered at this bit rate. The HP 37717C jitter Modulation amplitude is set to the level at which a **Bessel Null** is expected, then fine-tuned to maximize the null. The jitter Amplitude (UI pk-pk) displayed on the HP 37717C is checked to ensure it is within specified limits.

Equipment Required

Spectrum Analyzer	: HP 8568B Opt 001
Oscilloscope	: HP 54503A
75Ω/50Ω Matching Pad	: HP 11825B

Pre-Adjustment Setup

Before carrying out any adjustments to the HP 37717C Jitter Transmitter Module, perform the following pre-adjustment setup.

CAUTION

This procedure uses the special **MODULE DEBUG** display on the HP 37717C. When using the **MODULE DEBUG** display, **ONLY** modify the parameters shown. Altering other parameters can damage instrument firmware - exit the **MODULE DEBUG** display after setup to prevent accidental damage.

1. Recall the HP 37717C DEFAULT SETTINGS as shown on 3-2.
2. Setup the HP 37717C **OTHER** display as shown opposite.

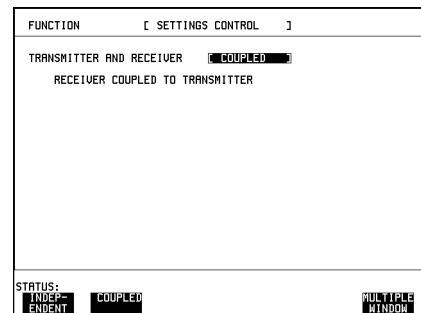

Performance Tests

Transmitted Jitter Amplitude Accuracy (Option UHK)

3. Make the following key sequence on the HP 37717C to obtain the special **MODULE DEBUG** display.

Press **OTHER**; **←**; **MORE**; **←**;
MORE; **←**; **MORE**; **OTHER**.

Press **MORE** until **MODULE DEBUG** appears in the softkey menu.

Press **MODULE DEBUG** and select MODULE PDH Module.

Set the VCO Control Mode to FIXED.

FUNCTION		[MODULE DEBUG]	
MODULE	[PDH MODULE]		
SPH MODULE	[TX]		
VCO CONTROL MODE	[FIXED]		
DOWNLOAD LCA DESIGN	[.]		
INTD H/W SITE NUMBER	[.]		
TOGGLE TO DOWNLOAD	[OFF]		
TXPRAT (-----)	TPDHMP (-----)		
TXPRM (-----)	TXPDH0 (-----)		
DISCRIM (-----)	TXPDH1 (-----)		
TXCODER (-----)	TXPDH2 (-----)		
TXINS (-----)	TXPDH3 (-----)		
TXCNTR (-----)			

STATUS: **NORMAL** **FIXED** **MULTIPLE WINDOW**

CAUTION

The sequence above must be performed each time the power is cycled on the HP 37717C, as all **MODULE DEBUG** parameters adopt DEFAULT values when power is cycled.

Procedure

Transmitted Jitter Amplitude Accuracy on Range 1

1. Setup the HP 37717C **TRANSMIT** display as shown opposite.

TRANSMITTER OUTPUT		[PDH]	
PRN	STRUCT'D	JITTER	TEST
SETTINGS	SETTINGS	FUNCTION	FUNCTION
SIGNAL	[2 Mb/s]		
CLOCK SYNC	[INTERNAL]		
TERMINATION	[75Ω UNBAL]		
LINE CODE	[HD3]		
FREQUENCY OFFSET	[OFF]		
PAYLOAD TYPE	[UNFRAMED]		
PATTERN	[ALL ONES]		

STATUS: **MULTIPLE WINDOW**

Performance Tests

Transmitted Jitter Amplitude Accuracy (Option UHK)

2. Select TRANSMITTER OUTPUT SETTINGS [JITTER] and setup the display as shown opposite.

TRANSMITTER OUTPUT [PDH]	
PDH	[JITTER]
TEST FUNCTION	
JITTER / WANDER	[JITTER]
JITTER	[ON]
SIGNAL FREQUENCY	[2 Mb/s]
MODULATION SOURCE	[INTERNAL]
JITTER MASK	[OFF]
CLOCK SYNC INTERNAL	
RANGE	[1.0 UI]
MODULATION FREQUENCY	[2500 Hz]
AMPLITUDE	[0.77 UI]

STATUS: MULTIPLE WINDOW

3. Set the Spectrum Analyzer as follows:

Centre Frequency - 2048 kHz

Frequency Span - 25 kHz

Reference Level - 0 dBm

Sweep Time - 1.0 s

Video Bandwidth - 1 kHz

Resolution Bandwidth - 100Hz

4. Connect up the equipment as shown in Figure 3-44.

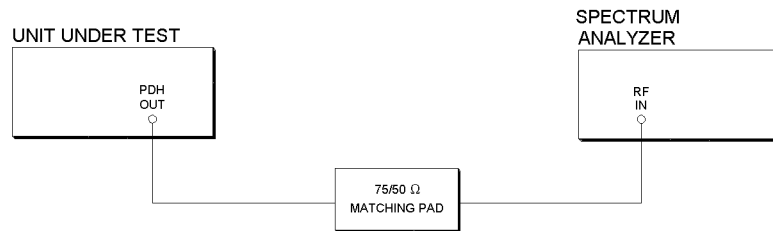

Figure 3-44

TX Jitter Accuracy Test Setup

5. Adjust the HP 37717C jitter amplitude until the first **Bessel Null** is observed on the Spectrum Analyzer i.e first dip in the carrier level. (As an example, Figure 3-45 shows the first Bessel Null for 34MHz.)

6. Ensure the Jitter amplitude displayed on the HP 37717C is between the minimum and maximum limits given in Table 3-5.

Performance Tests

Transmitted Jitter Amplitude Accuracy (Option UHK)

7. Check the Jitter accuracy for each value in Table 3-5. In each case, set the HP 37717C Rate and Spectrum Analyzer Center Frequency to the value given in column 1 of the table (**Set the HP 37717C PATTERN to ALL ONES and jitter AMPLITUDE to minimum after each change of Bit Rate**). Set the HP 37717C Jitter Modulation Frequency and Amplitude to the values given in columns 2 and 3 of the table. Fine-tune the amplitude to obtain the lowest carrier level on the Spectrum Analyzer display and check that the jitter amplitude displayed on the HP 37717C is between the limits given in columns 4 and 5 of Table 3-5.

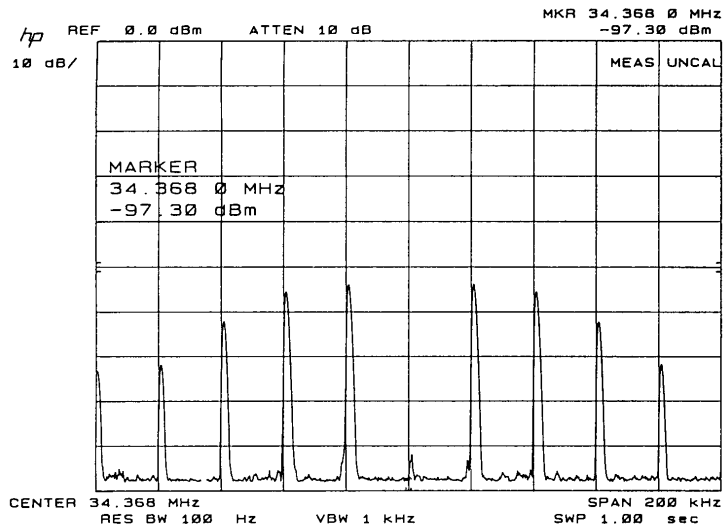

Figure 3-45

Bessel Null Example

Table 3-5

Range 1 Tx Jitter Amplitude Accuracy

Bit Rate/ Center Frequency	Modulation Frequency	Jitter Amplitude (UI)	Minimum Jitter (UI)	Maximum Jitter (UI)
2048kHz	2400Hz	0.77	0.69	0.83
8448kHz	10700Hz	0.77	0.69	0.83
34368kHz	4000Hz	0.77	0.69	0.83
139264kHz	4000Hz	0.77	0.68	0.84

Performance Tests

Transmitted Jitter Amplitude Accuracy (Option UHK)

Transmitted Jitter Accuracy on Range 10

8. Setup the HP 37717C **TRANSMIT** display as shown opposite.

TRANSMITTER OUTPUT	[PDH]
MAIN STRUCT'D	JITTER TEST
SETTINGS SETTINGS	FUNCTION
SIGNAL	[2 Mb/s]
CLOCK SYNC	[INTERNAL]
TERMINATION	[75Ω UNBAL]
LINE CODE	[HDB3]
FREQUENCY OFFSET	[OFF]
PAYLOAD TYPE	[UNFRAMED]
PATTERN	[ALL ONES]
STATUS:	
MULTIPLE WINDOW	

9. Select **TRANSMIT JITTER** and setup the display as shown opposite.

TRANSMITTER OUTPUT	[PDH]
PDH	JITTER TEST
	FUNCTION
JITTER / WANDER	[JITTER]
JITTER	[ON]
SIGNAL FREQUENCY	[2 Mb/s]
MODULATION SOURCE	[INTERNAL]
JITTER MASK	[OFF]
CLOCK SYNC	INTERNAL
RANGE	[10 UI]
MODULATION FREQUENCY	[2400 Hz]
AMPLITUDE	[1.8 UI]
STATUS:	
MULTIPLE WINDOW	

10. Set the Spectrum Analyzer as follows:

Centre Frequency - 2048 kHz

Frequency Span - 25 kHz

Reference Level - 0 dBm

Sweep Time - 1.0 s

Video Bandwidth - 1 kHz

Resolution Bandwidth - 100Hz

11. Adjust the HP 37717C jitter amplitude until the second **Bessel Null** is observed on the Spectrum Analyzer i.e second dip in the carrier level.

12. Ensure the Jitter amplitude displayed on the HP 37717C is between the minimum and maximum limits given in Table 3-6.

13. Check the Jitter accuracy for each value in Table 3-6. In each case, set the HP 37717C Rate and Spectrum Analyzer Center Frequency to the value given in column 1 of the table (**Set the HP 37717C PATTERN to ALL ONES and the jitter**

Performance Tests

Transmitted Jitter Amplitude Accuracy (Option UHK)

AMPLITUDE to minimum after each change of Bit Rate). Set the HP 37717C Jitter Modulation Frequency and Amplitude to the values given in columns 2 and 3 of the table. Fine-tune the amplitude to obtain the lowest carrier level on the Spectrum Analyzer display and check that the jitter amplitude displayed on the HP 37717C is between the limits given in columns 4 and 5 of Table 3-6.

Table 3-6

Range 10 Tx Jitter Amplitude Accuracy

Bit Rate/ Center Frequency	Modulation Frequency	Jitter Amplitude (UI)	Minimum Jitter (UI)	Maximum Jitter (UI)
2048kHz	2400Hz	1.8	1.5	2.0
2048kHz	2400Hz	4.8	4.4	5.1
2048kHz	2400Hz	8.8	8.2	9.3
8448kHz	10700Hz	1.8	1.5	2.0
8448kHz	10700Hz	5.8	5.3	6.2
8448kHz	10700Hz	8.8	8.2	9.3
34368kHz	4000Hz	2.8	2.5	3.0
34368kHz	4000Hz	6.8	6.2	7.3
34368kHz	4000Hz	8.8	8.2	9.3
139264kHz	4000Hz	3.8	3.3	4.2
139264kHz	4000Hz	7.8	7.1	8.4
139264kHz	4000Hz	8.8	8.1	9.4

Transmitted Jitter/Wander Amplitude Accuracy (Option A3K [A3Q])

Specifications

Jitter Generation:

Data Rates 2.048 Mb/s, 8.448 Mb/s, 34.368 Mb/s, 139.264 Mb/s,
155.52 Mb/s (STM-1), 622.08 Mb/s (STM-4)

Amplitude Range:

Overall Accuracy	$\pm 5\%$ \pm range accuracy \pm intrinsic jitter \pm High Frequency accuracy (STM-1E only)
Range 1	± 0.01 UI
Range 10	± 0.1 UI
Range 50	± 0.5 UI
Range 80	± 1.0 UI
Range 200	± 2.0 UI
Intrinsic Jitter 2 Mb/s	± 0.02 UI
Intrinsic Jitter 8 Mb/s	± 0.02 UI
Intrinsic Jitter 34 Mb/s	± 0.03 UI
Intrinsic Jitter 140 Mb/s	200 Hz to 5 kHz - ± 0.10 UI 5 kHz to 10 kHz - ± 0.05 UI >10 kHz - ± 0.02 UI
Intrinsic Jitter 155.52 Mb/s	< 10 kHz - ± 0.04 UI; > 10 kHz - ± 0.03 UI
Intrinsic Jitter 622.08 Mb/s	± 0.1 UI
High Frequency (STM-1E only)	± 0.0 to 0.2 UI, >1.3 MHz - typically $\pm 10\%$ > 0.2 UI, >1.3 MHz - typically $\pm 20\%$

Performance Tests

Transmitted Jitter/Wander Amplitude Accuracy (Option A3K [A3Q])

External Jitter:

Frequency Range	0.1 Hz to 5 MHz
Frequency Accuracy	> 3 Hz – $\pm 1\%$; < 3 Hz – $\pm 3\%$

Wander Generation:

Data Rates	2.048 Mb/s, 155.52 Mb/s (STM-1), 622.08 Mb/s (STM-4)
Overall Accuracy	$\pm 5\%$ \pm amplitude accuracy \pm intrinsic jitter
Amplitude Accuracy 2 Mb/s	± 1.0 UI
Amplitude Accuracy 155 Mb/s	± 0.5 UI
Amplitude Accuracy 622 Mb/s	± 0.5 UI
Intrinsic Jitter 2 Mb/s	± 0.1 UI
Intrinsic Jitter 155 Mb/s	± 0.1 UI
Intrinsic Jitter 622 Mb/s	± 0.1 UI
Frequency Range	0.000010 Hz to 0.125000 Hz
Frequency Accuracy	$\pm 1\%$

Wander Timing Reference Input:

Bit Rate	2.048 Mb/s ± 100 ppm
Format	Clock or HDB3 Data
Peak Level	Balanced - 3V $\pm 10\%$ Unbalanced 2.37V $\pm 10\%$

External Jitter Modulation Input:

Input Range	10 UI, 2 UI
Voltage Range (At 10 kHz)	0.7V pk_pk/UI ± 0.2 V pk_pk/UI on 10 UI range 3 V pk_pk/UI ± 1 V pk_pk/UI on 2 UI range
Maximum Input Level	6V peak AC/DC composite

Description

To check the accuracy of the internal jitter generator, a signal is output from the HP 37717C to a Spectrum Analyzer. The signal can be at one of the PDH rates of 2 Mb/s, 8 Mb/s, 34 Mb/s or 140 Mb/s from the PDH TX module or at 155 Mb/s from the SDH module. At each of the rates, jitter is added to the signal until Bessel Null points are observed on the Spectrum Analyzer. The jitter amplitudes required to obtain these Bessel Nulls are checked to ensure they are within the specified limits.

For high levels of jitter amplitude at 2 Mb/s and 155 Mb/s, it is difficult to measure Bessel Null points accurately on the Spectrum Analyzer. To measure Bessel Null points at high jitter amplitudes, a Modulation Analyzer is used. The Modulation Analyzer demodulates the jitter from the carrier and converts the jitter amplitude to frequency deviation. The frequency deviation result is based upon the level of jitter amplitude and the modulating frequency. Jitter generation at 622 Mb/s is a function of the HP 37717C firmware and is based on jitter generation at 155 Mb/s and is not tested in this performance test.

For external jitter generation, a modulating signal is input from the synthesizer at the MOD input of the A3K module. The amplitude of the modulating signal is increased until a Bessel Null is observed on the Spectrum Analyzer. The modulating signal level is checked on the Oscilloscope to ensure it is within the specified limits.

To check Wander generation, an external reference 2 Mb/s clock is input to the 2M REF IN port on the Jitter TX module of the HP 37717C under test and to the 2M REF IN port on the Jitter RX module of the reference HP 37717C. Low frequency Wander is added to the 2 Mb/s data which is output from the PDH OUT port and compared with the 2 Mb/s reference clock to allow Wander measurements to be made. Wander generation at 155 Mb/s and 622 Mb/s is a function of the HP 37717C firmware and is based on jitter generation at 2 Mb/s and is therefore not tested in this performance test.

Equipment Required

Communications Performance Analyzer	: HP 37717C Opt UHN
Spectrum Analyzer	: HP 8568B Opt 001
Oscilloscope	: HP 54503A
Modulation Analyzer	: HP 9801A/B
Synthesizer	: HP 3325B
75Ω/50Ω Matching Pad	: HP 11825B

Pre-Adjustment Setup

Before carrying out any adjustments to the HP 37717C Jitter Transmitter Module, perform the following pre-adjustment setup.

CAUTION

This procedure uses the special **MODULE DEBUG** display on the HP 37717C. When using the **MODULE DEBUG** display, **ONLY** modify the parameters shown. Altering other parameters can damage instrument firmware - exit the **MODULE DEBUG** display after setup to prevent accidental damage.

1. Recall the HP 37717C DEFAULT SETTINGS as shown on 3-2.
2. Setup the HP 37717C **OTHER** display as shown opposite.

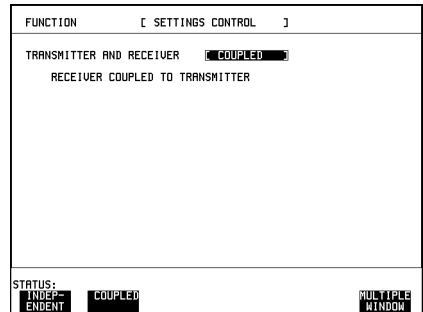

Performance Tests

Transmitted Jitter/Wander Amplitude Accuracy (Option A3K [A3Q])

3. Make the following key sequence on the HP 37717C to obtain the special **MODULE DEBUG** display.

Press **OTHER**; **←**; **MORE**; **←**;
MORE; **←**; **MORE**; **OTHER**.

Press **MORE** until **MODULE DEBUG** appears in the softkey menu.

Press **MODULE DEBUG** and select MODULE PDH Module.

Set the VCO Control Mode to FIXED.

FUNCTION		[MODULE DEBUG]	
MODULE	[PDH MODULE]		
SPDH MODULE	[TX]		
UCO CONTROL MODE	[FIXED]		
DOWNLOAD LCA DESIGN	[..]		
INTD H/W SITE NUMBER	[..]		
TOGGLE TO DOWNLOAD	[OFF]		
TXPRM	(-----) TPDHMP (-----)		
TXPRM	(-----) TPDH0 (-----)		
DISCRIM	(-----) TPDH1 (-----)		
TXCODER	(-----) TPDH2 (-----)		
TXINS	(-----) TPDH3 (-----)		
TXCNTR	(-----)		

STATUS: **NORMAL** **FIXED** **MULTIPLE WINDOW**

CAUTION

The sequence above must be performed each time the power is cycled on the HP 37717C, as all **MODULE DEBUG** parameters adopt DEFAULT values when power is cycled.

Procedure

Transmitted PDH Jitter Amplitude Accuracy on Range 1

1. Select **TRANSMIT** and setup the HP 37717C display as shown opposite.

TRANSMITTER OUTPUT		[PDH]	
TRANSMIT	STRUCT'D	JITTER	TEST
SETTINGS	SETTINGS	FUNCTION	
SIGNAL	[2 Mb/s]		
CLOCK SYNC	[INTERNAL]		
TERMINATION	[75Ω UNBAL]		
LINE CODE	[HD3]		
FREQUENCY OFFSET	[OFF]		
PAYLOAD TYPE	[UNFRAMED]		
PATTERN	[ALL ONES]		

STATUS: **MULTIPLE WINDOW**

Performance Tests

Transmitted Jitter/Wander Amplitude Accuracy (Option A3K [A3Q])

2. Select **TRANSMIT JITTER** and setup the display as shown opposite.

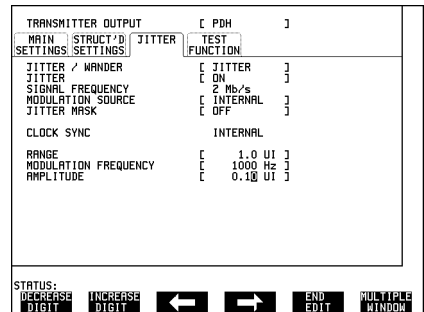

3. Set the Spectrum Analyzer as follows:

Centre Frequency - 2048 kHz

Frequency Span - 25 kHz

Reference Level - 0 dBm

Sweep Time - 1.0 s

Video Bandwidth - 1 kHz

Resolution Bandwidth - 100Hz

4. Connect up the equipment as shown in Figure 3-46.

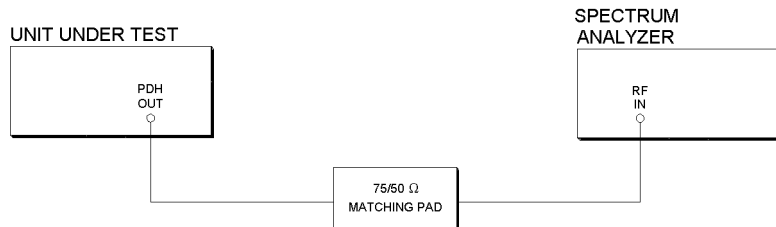

Figure 3-46

TX Jitter Accuracy Test Setup PDH Range 1 & 10

5. Adjust the HP 37717C jitter amplitude (approximately 0.77 UI) until the first **Bessel Null** is observed on the Spectrum Analyzer i.e first dip in the carrier level. (As an example Figure 3-47 shows the first Bessel Null for 34MHz.)
6. Ensure the Jitter amplitude displayed on the HP 37717C is between the minimum and maximum limits given in Table 3-7.

Performance Tests

Transmitted Jitter/Wander Amplitude Accuracy (Option A3K [A3Q])

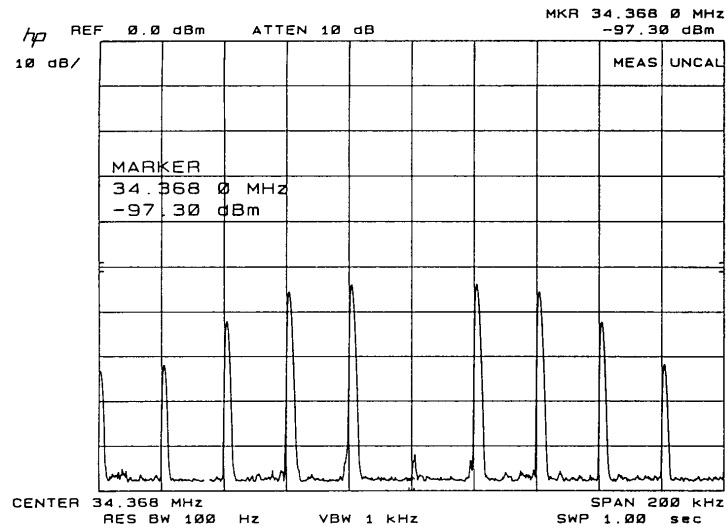

Figure 3-47

Bessel Null Example

7. Check the Jitter accuracy for each value in Table 3-7. In each case, set the HP 37717C Rate and Spectrum Analyzer Center Frequency to the value given in column 1 of the table (**Set the HP 37717C PATTERN to ALL ONES and jitter AMPLITUDE to minimum after each change of Bit Rate**). Set the HP 37717C Jitter Modulation Frequency and Amplitude to the values given in columns 2 and 3 of the table. Fine-tune the amplitude to obtain the lowest carrier level on the Spectrum Analyzer display and check that the jitter amplitude displayed on the HP 37717C is between the limits given in columns 4 and 5 of Table 3-7.

Table 3-7

PDH Range 1 Tx Jitter Amplitude Accuracy

Bit Rate/ Center Frequency	Modulation Frequency	Jitter Amplitude (UI)	Minimum Jitter (UI)	Maximum Jitter (UI)
2048kHz	2400Hz	0.77	0.69	0.83
8448kHz	10700Hz	0.77	0.69	0.83
34368kHz	4000Hz	0.77	0.69	0.83
139264kHz	4000Hz	0.77	0.68	0.84

Transmitted PDH Jitter Accuracy on Range 10

8. Setup the HP 37717C **TRANSMIT** display as shown below.

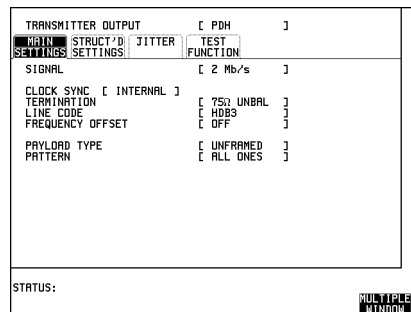

9. Select **TRANSMIT JITTER** and setup the display as shown below.

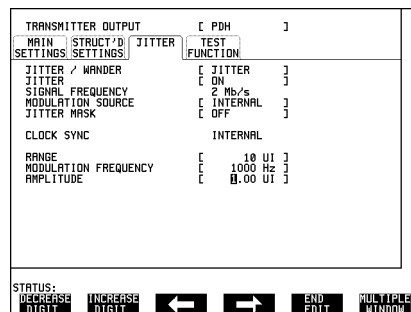

Performance Tests

Transmitted Jitter/Wander Amplitude Accuracy (Option A3K [A3Q])

10. Set the Spectrum Analyzer as follows:

Centre Frequency - 2048 kHz

Frequency Span - 25 kHz

Reference Level - 0 dBm

Sweep Time - 1.0 s

Video Bandwidth - 1 kHz

Resolution Bandwidth - 100Hz

11. Adjust the HP 37717C jitter amplitude until the second **Bessel Null** is observed on the Spectrum Analyzer i.e second dip in the carrier level .

12. Ensure the Jitter amplitude displayed on the HP 37717C is between the minimum and maximum limits given in Table 3-8.

13. Check the Jitter accuracy for each value in Table 3-8. In each case, set the HP 37717C Rate and Spectrum Analyzer Center Frequency to the value given in column 1 of the table (**Set the HP 37717C PATTERN to ALL ONES and the jitter AMPLITUDE to minimum after each change of Bit Rate**). Set the HP 37717C Jitter Modulation Frequency and Amplitude to the values given in columns 2 and 3 of the table. Fine-tune the amplitude to obtain the lowest carrier level on the Spectrum Analyzer display and check that the jitter amplitude displayed on the HP 37717C is between the limits given in columns 4 and 5 of Table 3-8.

Table 3-8

Range 10 Tx Jitter Amplitude Accuracy

Bit Rate/ Center Frequency	Modulation Frequency	Jitter Amplitude (UI)	Minimum Jitter (UI)	Maximum Jitter (UI)
2048kHz	2400Hz	1.8	1.5	2.0
2048kHz	2400Hz	4.8	4.4	5.1
2048kHz	2400Hz	8.8	8.2	9.3
8448kHz	10700Hz	1.8	1.5	2.0
8448kHz	10700Hz	5.8	5.3	6.2
8448kHz	10700Hz	8.8	8.2	9.3
34368kHz	4000Hz	2.8	2.5	3.0

Performance Tests

Transmitted Jitter/Wander Amplitude Accuracy (Option A3K [A3Q])

Table 3-8

Range 10 Tx Jitter Amplitude Accuracy continued

Bit Rate/ Center Frequency	Modulation Frequency	Jitter Amplitude (UI)	Minimum Jitter (UI)	Maximum Jitter (UI)
34368kHz	4000Hz	6.8	6.2	7.3
34368kHz	4000Hz	8.8	8.2	9.3
139264kHz	4000Hz	3.8	3.3	4.2
139264kHz	4000Hz	7.8	7.1	8.4
139264kHz	4000Hz	8.8	8.1	9.4

Transmitted SDH Jitter Accuracy on Ranges 1 & 10

1. Setup the HP 37717C **TRANSMIT** **SDH** display as shown opposite.

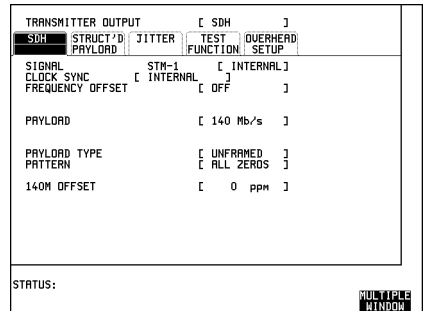

2. Select **TRANSMIT** **JITTER** and setup the display as shown opposite.

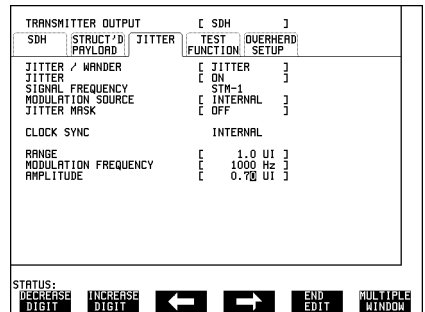

Performance Tests

Transmitted Jitter/Wander Amplitude Accuracy (Option A3K [A3Q])

3. Set the Spectrum Analyzer as follows:

Centre Frequency - 155.52 MHz

Frequency Span - 25 kHz

Reference Level - 0 dBm

Sweep Time - 1.0 s

Video Bandwidth - 1 kHz

Resolution Bandwidth - 100Hz

4. Connect up the equipment as shown in Figure 3-48.

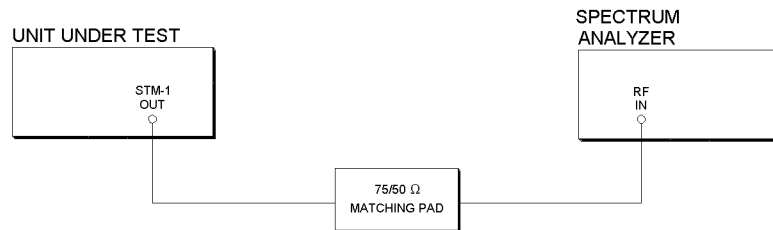

Figure 3-48

TX Jitter Accuracy Test Setup SDH Ranges 1 & 10

5. Adjust the HP 37717C jitter amplitude (approximately 0.77 UI) until the first **Bessel Null** is observed on the Spectrum Analyzer i.e first dip in the carrier level (see Figure 3-47).
6. Ensure the Jitter amplitude displayed on the HP 37717C is between 0.69 UI and 0.83 UI.
7. Select RANGE [10 UI] on the **TRANSMIT JITTER** display and adjust the jitter amplitude until the second **Bessel Null** is observed on the Spectrum Analyzer i.e second dip in the carrier level.
8. Ensure the Jitter amplitude displayed on the HP 37717C is between 1.7 UI and 1.8 UI.

Performance Tests

Transmitted Jitter/Wander Amplitude Accuracy (Option A3K [A3Q])

Transmitted SDH Jitter Accuracy on Range 50

1. Setup the HP 37717C **TRANSMIT** **SDH** display as shown opposite.

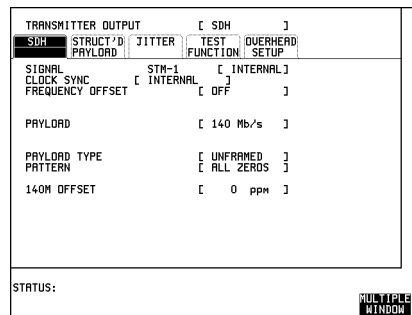

2. Select **TRANSMIT** **JITTER** and setup the display as shown opposite.

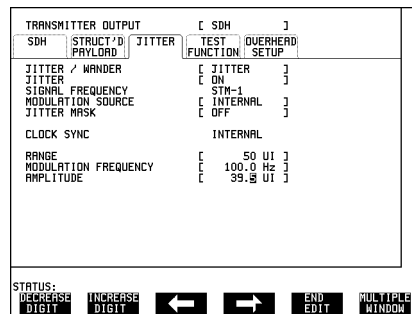

3. Connect up the equipment as shown in Figure 3-49.

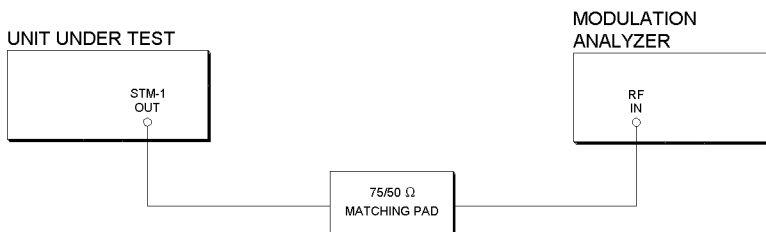

Figure 3-49

TX Jitter Accuracy Test Setup SDH Range 50

4. Press the [FREQ] key on the Modulation Analyzer and check that a frequency of 155.52 MHz is displayed. If 155.52 MHz is not displayed ENTER 155.52 MHz via the keypad.
5. Press [FM] ; [3kHz] and [Peak+] keys on the Modulation Analyzer and check that the result displayed is 62.4 kHz ± 3.95kHz.

Performance Tests

Transmitted Jitter/Wander Amplitude Accuracy (Option A3K [A3Q])

Transmitted PDH Jitter Accuracy on Range 80

1. Select **TRANSMIT** and setup the HP 37717C display as shown opposite.

TRANSMITTER OUTPUT	[PDH]		
MAIN	STRUCT'D	JITTER	TEST
SETTINGS	SETTINGS	FUNCTION	
SIGNAL			
[2 Mb/s]			
CLOCK SYNC [INTERNAL]			
TERMINATION	[75 Ω UNBAL]		
LINE CODE	[HDB3]		
FREQUENCY OFFSET	[OFF]		
PAYLOAD TYPE			
[UNFRAMED]			
PATTERN			
[ALL ONES]			
STATUS:			
MULTIPLE WINDOW			

2. Select **TRANSMIT JITTER** and setup the display as shown opposite.

TRANSMITTER OUTPUT	[PDH]		
MAIN	STRUCT'D	JITTER	TEST
SETTINGS	SETTINGS	FUNCTION	
JITTER / WANDER			
[JITTER]			
JITTER	[ON]		
SIGNAL FREQUENCY			
[2 Mb/s]			
MODULATION SOURCE			
[INTERNAL]			
JITTER MASK			
[OFF]			
CLOCK SYNC			
INTERNAL			
RANGE	[80 UI]		
MODULATION FREQUENCY	[100.0 Hz]		
AMPLITUDE	[39.5 UI]		
STATUS:			
MULTIPLE WINDOW			

3. Connect up the equipment as shown in Figure 3-50.

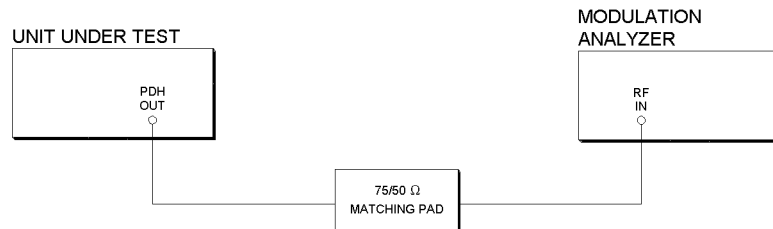

Figure 3-50

TX Jitter Accuracy Test Setup PDH Range 80

4. Press the [FREQ] key on the Modulation Analyzer and check that a frequency of 1.024 MHz is displayed. If 1.024 MHz is not displayed ENTER 1.024 MHz via the keypad.
5. Press [FM]; [3kHz] and [Peak+] keys on the Modulation Analyzer and check that the result displayed is 6.24 kHz \pm 480 Hz.

Performance Tests

Transmitted Jitter/Wander Amplitude Accuracy (Option A3K [A3Q])

External Jitter Generation

1. Select **TRANSMIT** and setup the HP 37717C display as shown opposite.

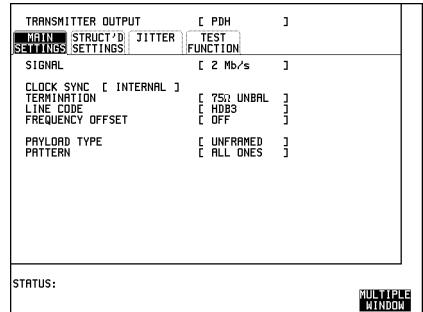

2. Select **TRANSMIT JITTER** and setup the display as shown opposite.

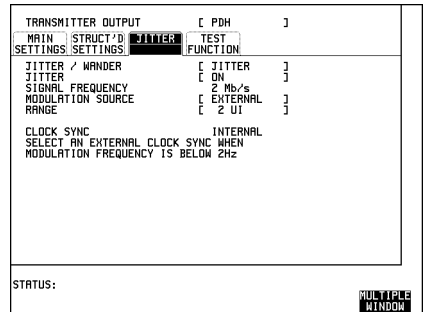

3. Set the Spectrum Analyzer as follows:

Centre Frequency - 2048 kHz

Frequency Span - 25 kHz

Reference Level - 0 dBm

Sweep Time - 1.0 s

Video Bandwidth - 1 kHz

Resolution Bandwidth - 100Hz

4. Set the Synthesizer to Frequency 10 kHz and minimum Output Level.

Transmitted Jitter/Wander Amplitude Accuracy (Option A3K [A3Q])

5. Connect up the equipment as shown in Figure 3-51.

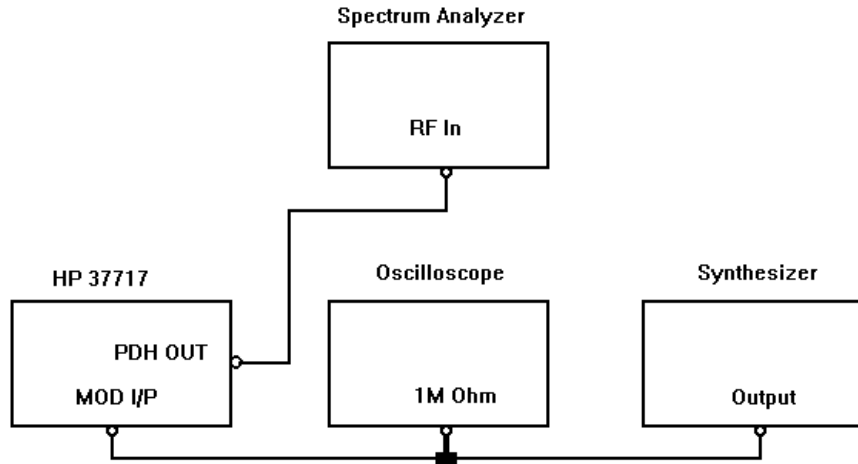

Figure 3-51

External Jitter Generation

6. Increase the Synthesizer output level until the first **Bessel Null** is observed on the Spectrum Analyzer.
7. Check that the amplitude of the Oscilloscope waveform is between 1.76V pk_pk and 2.84V pk_pk.

Wander Generation

1. Select **TRANSMIT** and setup the Test HP 37717C display as shown opposite.

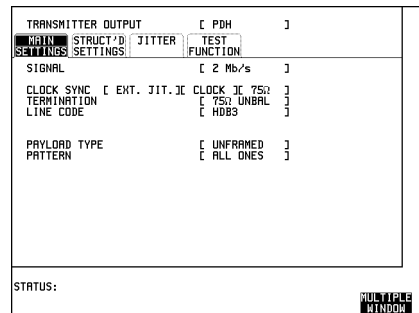

Performance Tests

Transmitted Jitter/Wander Amplitude Accuracy (Option A3K [A3Q])

2. Select **TRANSMIT JITTER** and setup the Test HP 37717C display as shown opposite.

TRANSMITTER OUTPUT	[PDH]
MAIN SETTINGS	STRUCT'D SETTINGS: JITTER TEST FUNCTION
JITTER / WANDER	[WANDER]
WANDER	[ON]
SIGNAL FREQUENCY	[2 Mb/s]
MODULATION SOURCE	[INTERNAL]
WANDER MASK	[OFF]
CLOCK SYNC	EXT JITTER
CONNECT 2MHz SOURCE TO	JITTER TX MODULE
MODULATION FREQUENCY	[125000 µHz]
AMPLITUDE	[80.0 UI]
STATUS:	

MULTIPLE WINDOW

3. Connect up the equipment as shown in Figure 3-52.

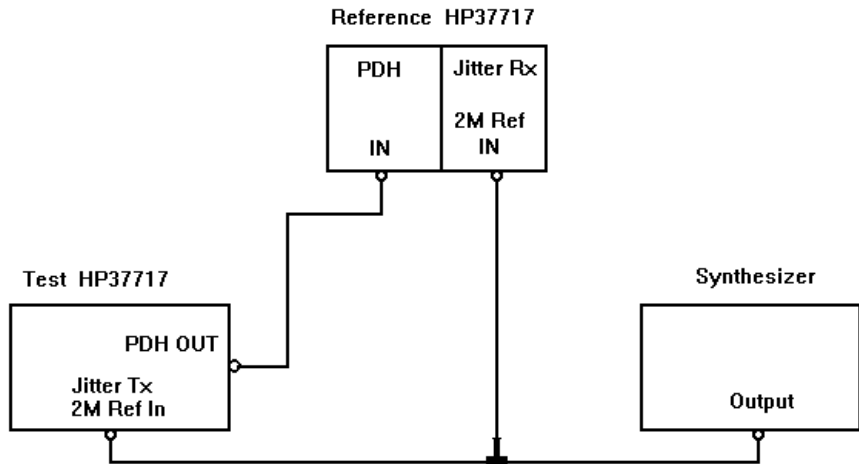

Figure 3-52

Wander Generation

4. Set the Synthesizer to Frequency 2.048 MHz and Output Level 5V pk_pk.

Performance Tests

Transmitted Jitter/Wander Amplitude Accuracy (Option A3K [A3Q])

5. Select **RECEIVE PDH** and setup the Reference HP 37717C display as shown opposite.

RECEIVER INPUT	[PDH]
MAIN STRUCT'D	JITTER
SETTINGS SETTINGS	
SIGNAL	[2 Mb/s]
TERMINATION	[75% UNBAL]
LINE CODE	[HDB3]
LEVEL	[TERMINATE]
PAYLOAD TYPE	[UNFRAMED]
PATTERN	[ALL ONES]

STATUS: **MULTIPLE WINDOW**

6. Select **RECEIVE JITTER** and setup the Reference HP 37717C display as shown opposite.

RECEIVER INPUT	[PDH]
MAIN STRUCT'D	JITTER
SETTINGS SETTINGS	
SIGNAL FREQUENCY	2 Mb/s
RECEIVER RANGE	[16 UI]
HIT THRESHOLD	[1.0 UI]
FILTER	[OFF]
WANDER	[ON]
WANDER REFERENCE	[75% UNBAL]
WANDER REF. FORMAT	[CLOCK]
CONNECT 2Mb/s SOURCE to JITTER RX MODULE	

STATUS: **MULTIPLE WINDOW**

7. Select **RESULTS TIMING CONTROL** and setup the Reference HP 37717C display as shown opposite.

RESULTS	TIMING CONTROL
SHORT TERM PERIOD	[1 SECOND]
TEST TIMING	[SINGLE] [10 SECS]
GRAPH STORAGE	[OFF]
	[INTERNAL]

STATUS: **TROUBLE SCAN** **TIMING CONTROL** **PDH RESULTS** **PDH ALN SCAN** **MORE** **MULTIPLE WINDOW**

8. Press **RUN/STOP** and check that at the end of the measurement period (10 seconds) the **RESULTS WANDER WANDER** display PEAK-PEAK result is 80.000 BITS \pm 5.5 BITS.

9. Disconnect all the test equipment.

Performance Tests

Received Jitter Accuracy (Options UHN, [US9], A1M [A1Q], A1N [A1R], A1P [A1S], A3L [A3M], A3V [A3W], A3N [A3P])

Received Jitter Accuracy (Options UHN, [US9], A1M [A1Q], A1N [A1R], A1P [A1S], A3L [A3M], A3V [A3W], A3N [A3P])

NOTE

PDH Tx and Rx modules must be fitted for this test - see Appendix B.

Specifications

Range 1.6 1.0V/UI $\pm 10\%$

Range 16 0.1V/UI $\pm 10\%$

Overall Accuracy: See main specifications in Section 1.

Description

The HP 37717C Jitter Receiver performance is verified using a special internal instrument calibration routine. This routine is automatic and tests all parameters except Hit Count and Demodulated Jitter Output.

Hit Count is tested by connecting PDH Signal Out to PDH Signal In with the transmitted jitter amplitude just exceeding the receiver Hit Threshold and a check made to ensure the Hit count is within the modulation frequency accuracy limits.

The Demodulated Jitter Output is verified for accuracy by measuring the amplitude on an oscilloscope.

Equipment Required

Spectrum Analyzer	: HP 8568B
75Ω/50Ω Matching Pad	: HP 11825B
Calibrated Jitter Generation Module	: See Note.
Oscilloscope	: HP 54503A
75Ω Termination	: HP 15522-80010

Performance Tests

Received Jitter Accuracy (Options UHN, [US9], A1M [A1Q], A1N [A1R], A1P [A1S], A3L [A3M], A3V [A3W], A3N [A3P])

Received Jitter Accuracy Procedure

1. Connect the HP 37717C Unbalanced 75Ω PDH Signal Out to PDH Signal In.
2. Connect the HP 37717C SDH OUT port on the SDH Module to the STM-1E port on the STM Jitter Receiver Module - only if fitted.
3. Connect the HP 37717C Optical Output on the STM-1/4 Optical Module to the Optical Input on the STM-1/4 Jitter Receiver Module - only if fitted.

CAUTION

If option URU is fitted, the Optical Output must be attenuated by 10 dB before connecting to the optical input of the Jitter Receiver Module. Failure to do this could result in damage to the HP 37717C. Refer to the Recommended Test Equipment Table for a suitable attenuator.

4. Recall the HP 37717C DEFAULT SETTINGS as shown on 3-2.
5. Setup the HP 37717C **OTHER** display as shown opposite.
6. Set CALIBRATE PASSWORD [1234].

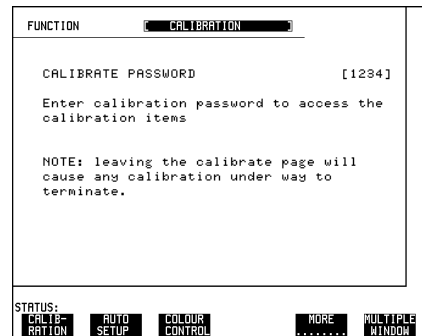

7. Select CALIBRATION ITEM [JITTER RX] and press **RUN/STOP**. The green **RUN/STOP** led will light.

The test is automatic and takes between approximately 30 minutes and 1 hour depending on which option is fitted.

When completed the **RUN/STOP** led will be off and the HP 37717C display will indicate the new calibration date.

Press **TRANSMIT** to return to normal operation.

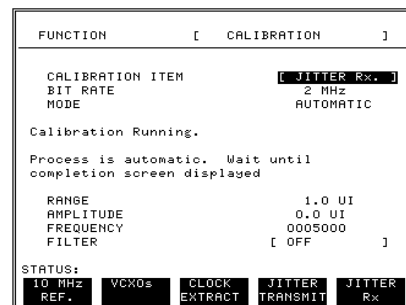

Performance Tests

Received Jitter Accuracy (Options UHN, [US9], A1M [A1Q], A1N [A1R], A1P [A1S], A3L [A3M], A3V [A3W], A3N [A3P])

Hit Count

8. Recall the HP 37717C DEFAULT SETTINGS as shown on 3-2.

9. Setup the HP 37717C **RECEIVE** display as shown opposite.

RECEIVER INPUT	[PDH]
MAIN STRUCT'D	JITTER
SETTINGS SETTINGS	
SIGNAL	[8 Mb/s]
TERMINATION	[75% UNBAL]
LINE CODE	[HDB3]
LEVEL	[TERMINATE]
PAYLOAD TYPE	[UNFRAMED]
PATTERN	[ALL ONES]
STATUS:	
	MULTIPLE WINDOW

10. Select **RECEIVE JITTER** and setup the display as shown opposite.

RECEIVER INPUT	[PDH]
MAIN STRUCT'D	JITTER
SETTINGS SETTINGS	
SIGNAL FREQUENCY	[8 Mb/s]
RECEIVER RANGE	[16 UI]
HIT THRESHOLD	[4.5 UI]
FILTER	[HP]
ADDITIONAL RMS FILTER	[OFF]
WANDER AVAILABLE AT 2MB/S ONLY	
STATUS:	
	MULTIPLE WINDOW

11. Setup the 37717C **TRANSMIT** display as shown opposite.

TRANSMITTER OUTPUT	[PDH]
MAIN STRUCT'D	JITTER
SETTINGS SETTINGS	TEST
	FUNCTION
SIGNAL	[8 Mb/s]
CLOCK SYNC	[INTERNAL]
TERMINATION	[75% UNBAL]
LINE CODE	[HDB3]
FREQUENCY OFFSET	[OFF]
PAYLOAD TYPE	[UNFRAMED]
PATTERN	[ALL ONES]
STATUS:	
	MULTIPLE WINDOW

Performance Tests

Received Jitter Accuracy (Options UHN, [US9], A1M [A1Q], A1N [A1R], A1P [A1S], A3L [A3M], A3V [A3W], A3N [A3P])

12. Select **TRANSMIT JITTER** and setup the display as shown below.

TRANSMITTER OUTPUT		[PDH]
MAIN	STRUCT'D	TEST
SETTINGS	SETTINGS	JITTER
JITTER / WANDER		JITTER
JITTER		[ON]
SIGNAL FREQUENCY		[8 Mb/s]
MODULATION SOURCE		[INTERNAL]
JITTER MASK		[OFF]
CLOCK SYNC		10700 INTERNAL
RANGE		[10 UI]
MODULATION FREQUENCY		[10700 Hz]
AMPLITUDE		[5.0 UI]

STATUS: **MULTIPLE WINDOW**

13. Select **RESULTS TIMING CONTROL** TEST TIMING [SINGLE] [10 SECS].

14. Set up the HP 37717C **RESULTS** as shown opposite.

Press **RUN/STOP** to start the measurement.

When the measurement is complete check the displayed Hit Count is between 211,860 and 216,140.

RESULTS	[JITTER]	[CUMULATIVE]
HITS	AMPLITUDE	
	TUDE	
HIT COUNT		
HIT SEC		
FREE SEC		
ELAPSED TIME		

STATUS: **MULTIPLE WINDOW**

Demodulated Jitter Output

15. Connect the HP 37717C Demodulated Jitter Output to the oscilloscope terminated in 75Ω .

16. Check that the amplitude of the 10.7 kHz displayed waveform is between 435mV pk_pk and 565mV pk_pk.

17. Disconnect all test equipment.

Performance Tests

Wander/Slips Measurement (Options UHN, [US9], A1M [A1Q], A1N [A1R], A1P [A1S], A3L [A3M], A3V [A3W], A3N [A3P])

Wander/Slips Measurement (Options UHN, [US9], A1M [A1Q], A1N [A1R], A1P [A1S], A3L [A3M], A3V [A3W], A3N [A3P])

NOTE

A jitter Tx Module must be fitted for this test - see Appendix B.

Specifications

Timing Reference Input:

Type	External MTS Clock as per ITU G.811.
Rate	2.048Mb/s \pm 100 ppm
Format	Clock or HDB3 Data.
Impedance	75 Ω Unbalanced (nominal); 120 Ω Balanced (nominal).
Peak Level	2.37V \pm 10% (unbalanced), 3V \pm 10% (balanced).
Indication	If no reference input signal is present NO REF is displayed.
Connectors	BNC (unbalanced); 3-pin Siemens audio (balanced).

Wander Measurement:

Bandwidth	Low pass response -3dB at 10Hz (nominal)
Resolution	0.125 UI
Accuracy	\pm 0.125 UI \pm 0.5% of reading valid up to 1Hz wander frequency.
Range	\pm 99999 UI.
Alarm Indication	"Excess Wander" displayed if $>$ 5UI
Wander Measurements	Positive Peak, Negative Peak, Peak to Peak 15 mins, Peak to Peak 24 hours, Time Interval Error
Slips Measurements	Estimated Bit Slips, Estimated Frame Slips

Performance Tests

Wander/Slips Measurement (Options UHN, [US9], A1M [A1Q], A1N [A1R], A1P [A1S], A3L [A3M], A3V [A3W], A3N [A3P])

Description

In the first part of the test the HP 37717C Transmitter output is connected to the Receiver Data and Reference Inputs simultaneously. The Wander measurement result should be zero with this configuration since both inputs are effectively in phase at the same frequency. This tests the wander measurement accuracy and the Timing Reference Input circuitry (Balanced and Unbalanced data) as the wander counters are latched by a division of the Reference Input and used to count the received input bits.

In the second part of the test Wander and Slips measurements are verified using two Clock Sources - one as input to the Receiver port and the other as input to the Reference port. The sources are locked together but with one source offset by a known frequency. This provides a known number of Bit Slips which are counted and displayed by the HP 37717C as Frame/Bit Slips and Wander.

Equipment Required

Synthesizer (2 off)	: HP 3325B
120/75Ω Bal/Unbal Converter	: HP 15508C
T Connector	: HP 1250-0781

Procedure

1. Recall the HP 37717C DEFAULT SETTINGS as shown on 3-2. Select **OTHER** **SETTINGS CONTROL** TRANSMITTER AND RECEIVER [COUPLED].

Wander Accuracy

2. Press **TRANSMIT** and set up the display as shown opposite.

TRANSMITTER OUTPUT	[PDH]
MAIN STRUCT'D	[JITTER]
SETTINGS SETTINGS	[TEST]
	[FUNCTION]
SIGNAL	[2 Mb/s]
CLOCK SYNC [INTERNAL]	
TERMINATION	[75Ω UNBAL]
LINE CODE	[HD30]
FREQUENCY OFFSET	[OFF]
PAYLOAD TYPE	[UNFRAMED]
PATTERN	[2 ⁿ 2 ⁿ -1 PRBS]
PRBS POLARITY	[INU] CCITT
STATUS:	
MULTIPLE WINDOW	

Performance Tests

Wander/Slips Measurement (Options UHN, [US9], A1M [A1Q], A1N [A1R], A1P [A1S], A3L [A3M], A3V [A3W], A3N [A3P])

3. Press **RECEIVE** and set up the display as shown opposite.

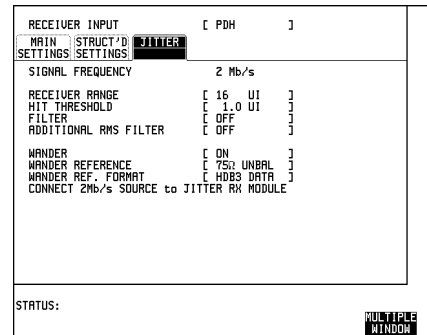

4. Press **RESULTS** and set up the display as shown opposite.

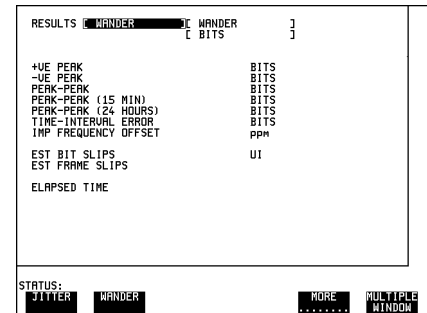

5. Connect the unbalanced 75Ω PDH OUT port to the unbalanced 75Ω PDH IN port and the unbalanced 75Ω TIMING REF INPUT (Jitter Receiver Module) simultaneously using the T-piece.

6. Press **RUN/STOP** and verify that the display shows POSITIVE PEAK WANDER and NEGATIVE PEAK WANDER readings of 0.000 ± 0.125 BITS.

7. Press **RUN/STOP** to stop the measurement.

8. Disconnect the PDH OUT port from the unbalanced 75Ω TIMING REF INPUT and connect to the balanced 120Ω TIMING REF INPUT via the HP 15508C Balanced to Unbalanced Converter.

9. Press **RECEIVE** and select WANDER REFERENCE [120Ω BAL].

10. Press **RUN/STOP** and verify that the display shows POSITIVE PEAK WANDER and NEGATIVE PEAK WANDER readings of 0.000 ± 0.125 BITS.

11. Remove the input from the TIMING REF port and check that the display indicates **NO REF**.

12. Press **RUN/STOP** to stop the measurement.

Performance Tests

Wander/Slips Measurement (Options UHN, [US9], A1M [A1Q], A1N [A1R], A1P [A1S], A3L [A3M], A3V [A3W], A3N [A3P])

Slips and Wander

13. Connect up the equipment as shown in Figure 3-53.

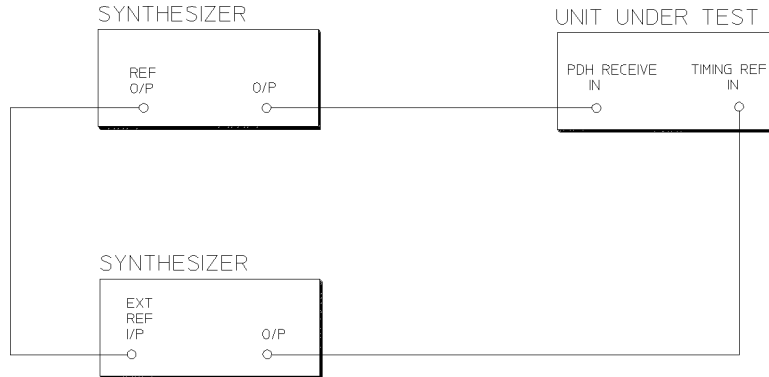

Figure 3-53

Slips and Wander Test Setup

14. Press **TRANSMIT** and set up the Display as shown opposite.

TRANSMITTER OUTPUT	[PDH]
MAIN STRUCT'D	JITTER TEST
SETTINGS SETTINGS:	FUNCTION
SIGNAL [2 Mb/s]	
CLOCK SYNC	[INTERNAL]
TERMINATION	[75Ω UNBAL]
LINE CODE	[8B1]
FREQUENCY OFFSET	[OFF]
PAYLOAD TYPE	[UNFRAMED]
PATTERN	[ALL ONES]
STATUS:	
MULTIPLE WINDOW	

15. Press **RECEIVE** and set up the display as shown opposite.

RECEIVER INPUT	[PDH]
MAIN STRUCT'D	JITTER
SETTINGS SETTINGS:	
SIGNAL FREQUENCY [2 Mb/s]	
RECEIVER RANGE	[1.6 UI]
HIT THRESHOLD	[1.00 UI]
FILTER	[OFF]
ADDITIONAL RMS FILTER	[OFF]
WANDER	[ON]
WANDER REFERENCE	[75Ω UNBAL]
WANDER REF. FORMAT	[CLOCK]
CONNECT 2Mb/s SOURCE to JITTER RX MODULE	
STATUS:	
MULTIPLE WINDOW	

Performance Tests

Wander/Slips Measurement (Options UHN, [US9], A1M [A1Q], A1N [A1R], A1P [A1S], A3L [A3M], A3V [A3W], A3N [A3P])

16. Select **RESULTS** **TIMING CONTROL** TEST TIMING [SINGLE] [60 SECS].

17. Press **RESULTS** and set up the Display as shown opposite.

18. Set both Synthesizers amplitude to 10dBm.

19. Set the Synthesizer connected to PDH IN to generate a sinewave at 1,024,094.4Hz and the Synthesizer connected to the TIMING REF INPUT to generate a sinewave at 2,048,204.8Hz.

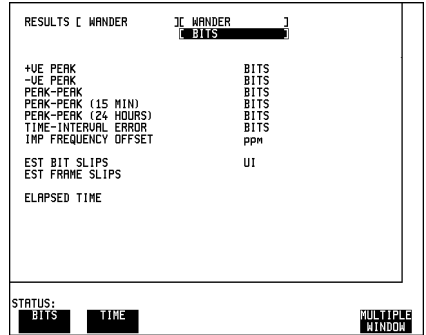

20. Press **RUN/STOP** and verify that the Display shows the following at the end of the test period:

ESTIMATED BIT SLIPS : -955 TO -964 BITS

ESTIMATED FRAME SLIPS : -3 to -4

21. Select **RESULTS** [WANDER] [WANDER] and verify that the display shows the following:

POSITIVE PEAK 0.000 BITS

NEGATIVE PEAK 955.125 to 964.875 BITS

PEAK TO PEAK 955.125 to 964.875 BITS

PEAK TO PEAK 15 MINUTESBITS

PEAK TO PEAK 24 HOURSBITS

TIME INTERVAL ERROR -955.125 to -964.875 BITS

NOTE: In some cases the above two sets of results will all be on the same display.

22. Select **RESULTS** [WANDER] [BIT SLIPS].

23. Set The Synthesizer connected to PDH IN to generate 1,023,889.6Hz and the Synthesizer connected to the TIMING REF INPUT to generate 2,047,795.2Hz and repeat steps 19 to 21.

24. Set The Synthesizer connected to PDH IN to generate 1,023,905.6 Hz.

Performance Tests

Wander/Slips Measurement (Options UHN, [US9], A1M [A1Q], A1N [A1R], A1P [A1S], A3L [A3M], A3V [A3W], A3N [A3P])

25. Press **RUN/STOP** and verify that the display shows the following at the end of the test period:

ESTIMATED BIT SLIPS	955 to 964
ESTIMATED FRAME SLIPS	3 to 4

26. Select RESULTS [WANDER] [WANDER] and verify that the display shows the following:

POSITIVE PEAK	955.125 to 964.875 BITS
NEGATIVE PEAK	0.000 BITS
PEAK TO PEAK	955.125 TO 964.875 BITS
PEAK TO PEAK 15 MINUTEBITS
PEAK TO PEAK 24 HOURSBITS
TIME INTERVAL ERROR	955.125 to 964.875 BITS

NOTE: In some cases the above two sets of results will all be on the same display.

Jitter Receiver STM-1E Input Equalization (Options A1M [A1Q], A1N [A1R], A1P [A1S], A3L [A3M], A3V [A3W], A3N [A3P])

NOTE

An SDH Module must be fitted for this test - see Appendix B.

Specification

Receiver Equalization Automatic for cable loss up to 12dB at half the bit rate.

Description

STM-1E Jitter Receiver Equalization is verified by inserting the special Cable between the STM-1 OUT port on the SDH Module and the STM-1 IN port on the Jitter Receiver Module and checking for error-free operation.

Equipment Required

Cable Attenuator (70 m) : HP 8120-0049

Procedure

1. Recall the HP 37717C DEFAULT SETTINGS as shown on 3-2.
2. Select TRANSMITTER OUTPUT [SDH] and RECEIVER INPUT [SDH JITTER].
3. Connect the STM-1 OUT port on the SDH Module to the STM-1 JITTER IN port on the Jitter Receiver Module, via the Cable Attenuator.
4. Verify that all the front panel Alarm leds are off.
5. Press **RESULTS** **TROUBLE SCAN** **RUN/STOP** and check that the display indicates NO TROUBLE.
6. Press **RUN/STOP** to halt the measurement.
7. Disconnect all the test equipment.

Jitter Receiver STM-1E Monitor Input (Options A1M [A1Q], A1N [A1R], A1P [A1S], A3L [A3M], A3V [A3W], A3N [A3P])

Jitter Receiver STM-1E Monitor Input (Options A1M [A1Q], A1N [A1R], A1P [A1S], A3L [A3M], A3V [A3W], A3N [A3P])

NOTE

An SDH Option must be fitted for this option to operate - see Appendix B.

Specification

Receiver Monitor Mode 20 dB of flat gain, 12dB Equalization at 1/2 Bit Rate

Description

A fixed attenuator and a special cable attenuator are inserted between the STM-1 OUT port and the Jitter Receiver STM-1 IN port. The STM-1E Jitter Receiver monitor mode is verified by attenuating the signal by 20dB, along with the cable attenuator, and checking for error-free operation.

Equipment Required

3 dB Attenuator (N-type)	: HP 8491A Option 003
6 dB Attenuator (N-type)	: HP 8491A Option 006 (Qty 2)
75/50Ω Matching Pad (N-type)	: HP 11852B (Qty 2)
N-type (f) to BNC (f) Adaptor	: HP 1250-1536 (Qty 2)
N-type (m) to N-type (f) Adaptor	: HP 1250-1475
Cable Attenuator (70m)	: HP 8120-0049

Procedure

1. Recall the HP 37717C DEFAULT SETTINGS as shown on 3-2.
2. Select TRANSMITTER OUTPUT [SDH] and RECEIVER INPUT [SDH JITTER].

Performance Tests

Jitter Receiver STM-1E Monitor Input (Options A1M [A1Q], A1N [A1R], A1P [A1S], A3L [A3M], A3V [A3W], A3N [A3P])

3. Connect up the equipment as shown in Figure 3-54. If Option A3L [A3M] or A3V [A3W] or A3N [A3P] is fitted connect both 6 dB attenuators between the Cable Attenuator and STMN-1 IN.

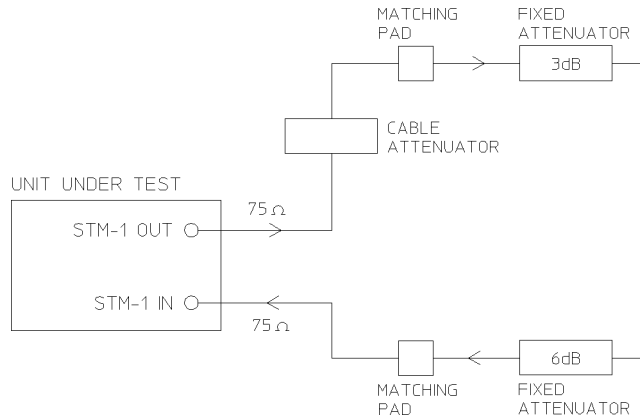

Figure 3-54

STM-1 Receiver Monitor Input

4. Press **SIGNAL IN** until the Monitor led above the key is lit.
5. Verify that all the front panel ALARM leds are off.
6. Press **RESULTS**; **TROUBLE SCAN** and **RUN/STOP**, and check that the display indicates NO TROUBLE.
7. Press **RUN/STOP** to halt the measurement.
8. Disconnect all the test equipment.

Jitter Receiver STM-1 Optical Interface (Options A1N, [A1R], A3V [A3W])

Jitter Receiver STM-1 Optical Interface (Options A1N, [A1R], A3V [A3W])

NOTE

This test requires other modules to be fitted - see Appendix B.

Specification

Wavelength	1200 nm to 1600 nm
Maximum Input Power	-8 dBm (for BER of $1.0E^{-10}$)
Line Coding	NRZ
Dynamic Range	20 dB minimum
Sensitivity	-28 dBm Minimum (wavelength=1300nm, Modulation=100%, Data= $2^{23}-1$, BER= $1.0E^{-10}$)

Description

The jitter receiver optical sensitivity is verified by attenuating the transmitter output and checking for no errors in back to back mode.

Equipment Required

Power Meter	: HP 8153A
Power Meter Sensor Module	: HP 81536A
FC/PC Connector Interface	: HP 81000FI (Qty. 4)
Optical Attenuator	: HP 8157A
Optical Cables (Qty. 2)	: HP 11871A

Performance Tests

Jitter Receiver STM-1 Optical Interface (Options A1N, [A1R], A3V [A3W])

WARNING

Safety precautions must be observed when handling the HP 37717C Optical Modules as these generate laser signals which can cause serious injury. The guidelines below must be followed:

Check the connector configuration of the Fiber Optic Interfaces. If these are fitted with a connector interface other than FC/PC then remove the existing connector interface and fit the FC/PC connector interface.

Check for any damage to the HP 37717C Fiber Optic Interface spring loaded aperture covers and connectors. Do not power up the instrument if in any doubt about the integrity of these connectors.

Make all connections to the HP 37717C Fiber Optic Interfaces before powering up the instrument.

Procedure

1. Connect the STM-1 Optical Out Port to the HP 8153A via the Optical Attenuator (ensure that all connections are tight and that the cable has no twists). Set the Optical Attenuator to ATTEN 0 dB, WAVELENGTH 1310 nm ; CAL=0.
2. Switch on the HP 37717C, check that immediately on power up the LASER ON led on the Optical Module illuminates for a few seconds.
3. Recall the HP 37717C DEFAULT SETTINGS as shown on 3-2.
4. Recall default settings on the HP 8153A:
Press **MODE** to select MENU mode on the HP 8153A.
Press **SYSTEM** to display RECALL.
Press **EDIT**, select 0 — **→**A and press **EXEC** to recall the default settings (wavelength = 1300 nm, measurement time = 200 ms, autorange).
5. Press **MODE** then **dBmw** to select the Power Level measurement on the HP 8153A.
6. Press **TRANSMIT** **SDH** on the HP 37717C and select SIGNAL [STM-1 OPT].
7. Verify that the Optical Module LASER ON led is on indicating the laser is enabled.
8. Adjust the Optical Attenuator to obtain a reading of -28 dBm on the Power Meter.
9. Press **OTHER** select STORED SETTINGS NUMBER [0] (Default Settings) and press **RECALL**.

Performance Tests

Jitter Receiver STM-1 Optical Interface (Options A1N, [A1R], A3V [A3W])

10. Verify that the LASER ON led is off before continuing.
11. Disconnect the Optical Attenuator Output from the HP 8153A and connect to the Optical In Port on the STM Jitter Receiver Module.
12. Press **TRANSMIT** **SDH** and select SIGNAL [STM-1 OPT].
13. Press **RECEIVE** and select SDH Jitter. Set signal to [STM-1 OPT].
14. Press **RESULTS** **TROUBLE SCAN** and then **RUN/STOP** to start a measurement.
15. After 5 minutes check that NO TROUBLE is displayed on the **RESULTS** display.
16. Press **OTHER** select STORED SETTINGS NUMBER [0] (Default Settings) and press **RECALL**.
17. Verify that the LASER ON led is off.
18. Disconnect the test equipment.

Jitter Receiver STM-1/STM-4 Optical Interface (Options A1P, [A1S], A3N [A3P])

NOTE

This test requires other modules to be fitted - see Appendix B.

Specification

Wavelength	1200 nm to 1600 nm
Maximum Input Power	-8 dBm (for BER of $1.0E^{-10}$)
Line Coding	NRZ
Dynamic Range	18 dB minimum
Sensitivity	-26 dBm Minimum (wavelength=1300nm, Modulation=100%, Data= $2^{23}-1$, BER= $1.0E^{-10}$)

Description

The Jitter Receiver optical sensitivity is verified by attenuating the transmitter outputs and checking for no errors in back to back mode at both STM-1 and STM-4 rates.

Equipment Required

Power Meter	: HP 8153A
Power Meter Sensor Module	: HP 81536A
FC/PC Connector Interface	: HP 81000FI (Qty. 4)
Optical Attenuator	: HP 8157A
Optical Cables (Qty. 2)	: HP 11871A

Jitter Receiver STM-1/STM-4 Optical Interface (Options A1P, [A1S], A3N [A3P])

WARNING

Safety precautions must be observed when handling the HP 37717C Optical Modules as these generate laser signals which can cause serious injury. The guidelines below must be followed;

Check the connector configuration of the Fiber Optic Interfaces. If these are fitted with a connector interface other than FC/PC then remove the existing connector interface and fit the FC/PC connector interface.

Check for any damage to the HP 37717C Fiber Optic Interface spring loaded aperture covers and connectors. Do not power up the instrument if in any doubt about the integrity of these connectors.

Make all connections to the HP 37717C Fiber Optic Interfaces before powering up the instrument.

Procedure

1. Connect the STM-1/STM-4 Optical Out Port to the HP 8153A Power Meter via the Optical Attenuator (ensure that all connections are tight and that the cable has no twists). Set the Optical Attenuator to ATTEN 0 dB, WAVELENGTH 1310 nm ; CAL=0.
2. Switch on the HP 37717C, check that immediately on power up the LASER ON led on the Optical Module illuminates for a few seconds and Recall the HP 37717C DEFAULT SETTINGS as shown on 3-2.
3. Recall the HP 37717C DEFAULT SETTINGS as shown on 3-2.
4. Recall default settings on the HP 8153A:
Press **MODE** to select MENU mode on the HP 8153A.
Press **SYSTEM** to display RECALL.
Press **EDIT**, select 0 — **→**A and press **EXEC** to recall the default settings (wavelength = 1300 nm, measurement time = 200 ms, autorange).
5. Press **MODE** then **dBmw** to select the Power Level measurement on the HP 8153A.
6. Press **TRANSMIT** **SDH** on the HP 37717C and select SIGNAL [STM-1 OPT].
7. Verify that the Optical Module LASER ON led is on indicating the laser is enabled.
8. Adjust the Optical Attenuator to obtain a reading of -28 dBm on the Power Meter.

Performance Tests

Jitter Receiver STM-1/STM-4 Optical Interface (Options A1P, [A1S], A3N [A3P])

9. Press **OTHER** select STORED SETTINGS NUMBER [0] (Default Settings) and press **RECALL**.
10. Verify that the LASER ON led is off before continuing.
11. Disconnect the Optical Attenuator Output from the HP 8153A and connect to the Optical In Port on the STM Jitter Receiver Module.
12. Press **TRANSMIT** **SDH** and select SIGNAL [STM-1 OPT].
13. Press **RECEIVE** and select SDH Jitter. Set signal to [STM-1 OPT].
14. Press **RESULTS** **TROUBLE SCAN** and then **RUN/STOP** to start a measurement.
15. After 5 minutes check that NO TROUBLE is displayed on the **RESULTS** display.
16. Press **OTHER** select STORED SETTINGS NUMBER [0] (Default Settings) and press **RECALL**.
17. Verify that the LASER ON led is off before continuing.
18. Repeat steps 1 through 16, selecting SIGNAL [STM-4 OPT] on both the Transmit and Receive pages.
19. Disconnect the test equipment.

PDH Binary Interfaces (Option UH3, [US7])

Specifications

	Clock O/P	Data O/P
Rate	700 kb/s to 50 Mb/s (TTL) 700 kb/s to 170 Mb/s (ECL)	700 kb/s to 50 Mb/s (TTL) 700 kb/s to 170 Mb/s (ECL)
Format	Nominal squarewave, 60/40 to 40/60 duty cycle	NRZ
Source Impedance	Nominal TTL into 75Ω to ground Nominal ECL into 75Ω to -2V	Nominal TTL into 75Ω to ground Nominal ECL into 75Ω to -2V

	Clock I/P	Data I/P
Rate	700 kb/s to 50 Mb/s (TTL) 700 kb/s to 170 Mb/s (ECL)	700 kb/s to 50 Mb/s (TTL) 700 kb/s to 170 Mb/s (ECL)
Format	Nominal squarewave, 60/40 to 40/60 duty cycle	NRZ
Logic Threshold	1.5V (TTL), -1.3V (ECL), ground, signal mean level	1.5V (TTL), -1.3V (ECL), ground, signal mean level
Termination	Nominal TTL into 75Ω to ground Nominal ECL into 75Ω to -2V	Nominal TTL into 75Ω to ground Nominal ECL into 75Ω to -2V

Performance Tests

PDH Binary Interfaces (Option UH3, [US7])

Rate (Option UKK [USB] Unstructured PDH) 700 kb/s to 50 Mb/s (TTL)
700 kb/s to 170 Mb/s (ECL)

Rate (Option UKJ [USA] Structured PDH) 2.048 Mb/s \pm 10% (ECL & TTL)
8.448 Mb/s \pm 10% (ECL & TTL)
34.368 Mb/s \pm 10% (ECL & TTL)
139.264 Mb/s \pm 10% (ECL only)

Format Nominal squarewave, 60/40 to 40/60 duty cycle

Logic Threshold 1.5V (TTL), -1.3V (ECL), ground, signal mean level

Termination Nominal TTL into 75 Ω to ground;
Nominal ECL into 75 Ω to -2V

Description

This test verifies that the PDH Binary Interface External Clock input meets its specification. The Clock input, Clock output, Data input and Data output are verified during self test.

Equipment Required

Digital Transmission Analyzer : HP 3764A Option 006

Signal Generator : HP 8657B

Oscilloscope : HP 54503A

75 Ω /50 Ω Matching Pad : HP 11825B

ECL Termination : HP 10086A

Procedure

External Clock Thresholds

1. Recall the HP 37717C DEFAULT SETTINGS as shown on 3-2.
2. Connect up the equipment as shown in Figure 3-55.

Performance Tests
PDH Binary Interfaces (Option UH3, [US7])

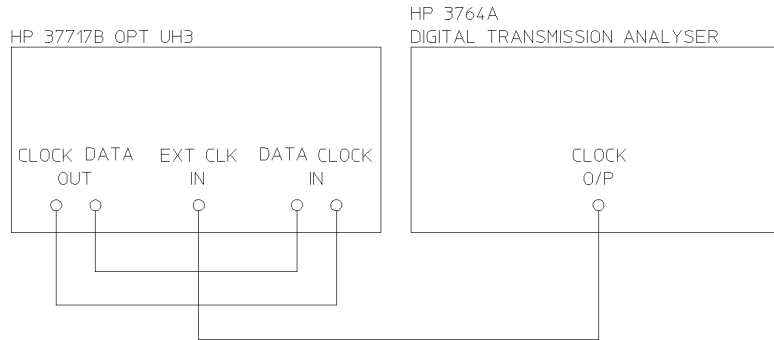
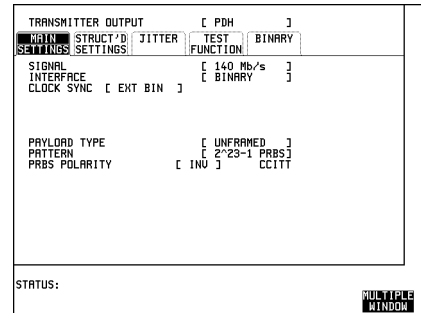

Figure 3-55

External Clock Thresholds

3. Press **TRANSMIT** **PDH** **MAIN** **SETTINGS** and set up the display as shown opposite.



4. Press **TRANSMIT** **PDH** **BINARY** and set up the display as shown opposite.

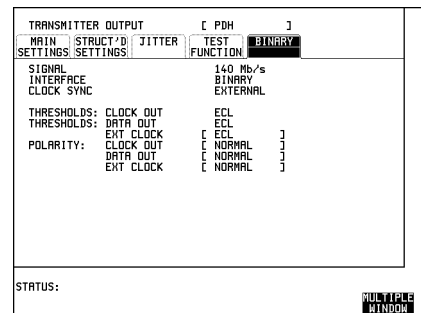

Performance Tests

PDH Binary Interfaces (Option UH3, [US7])

5. Press **RECEIVE** **PDH** **MAIN** **SETTINGS** and set up the display as shown opposite.

RECEIVER INPUT	[PDH]
MAIN SETTINGS	STRUCT'D SETTINGS JITTER BINARY
SIGNAL INTERFACE	[140 Mb/s] [BINARY]
PAYLOAD TYPE	[UNFRAMED]
PATTERN	[2 ²³ -1 PRBS]
PRBS POLARITY	[INU] CCITT
STATUS:	

MULTIPLE WINDOW

6. Press **RECEIVE** **PDH** **BINARY** and set up the display as shown opposite.

RECEIVER INPUT	[PDH]
MAIN SETTINGS	STRUCT'D SETTINGS JITTER BINARY
SIGNAL INTERFACE	140 Mb/s BINARY
THRESHOLDS:	CLOCK IN [ECL] DATA IN [ECL]
POLARITY:	CLOCK IN [NORMAL] DATA IN [NORMAL]
STATUS:	

MULTIPLE WINDOW

7. Recall default settings on the Digital Transmission Analyzer and select: Interface - NRZ BIN ECL Frequency - 170 MHz Pattern - 2²³-1
8. Check that the HP 37717C Pattern Loss and Signal Loss indicators are not lit.
9. Select the following on the Digital Transmission Analyzer:
- Frequency - 700 kHz
- Pattern 2¹⁵-1
10. Select SIGNAL 2 Mb/s and PATTERN 2¹⁵-1 on the HP 37717C **TRANSMIT** and **RECEIVE** displays.
11. Check that the HP 37717C Pattern Loss and Signal Loss indicators are not lit.
12. Select Interface - NRZ BIN TTL on the Digital Transmission Analyzer and THRESHOLDS EXT CLOCK - TTL on the HP 37717C **TRANSMIT** BINARY display.
13. Check that the HP 37717C Pattern Loss and Signal Loss indicators are not lit.

Performance Tests

PDH Binary Interfaces (Option UH3, [US7])

14. Select Frequency - 50 MHz on the Digital Transmission Analyzer and check that the HP 37717C Pattern Loss and Signal Loss indicators are not lit.

15. Select the following parameters on the Signal Generator: Frequency - 50 MHz
Output Level - 500 mV

16. Disconnect the Digital Transmission Analyzer and connect the Signal Generator to the HP 37717C EXT CLOCK INPUT.

17. Press **TRANSMIT** **PDH** **BINARY**
and set up the display as shown opposite.

Check that the HP 37717C Pattern Loss and Signal Loss indicators are not lit.

Select **THRESHOLDS EXT CLOCK**
[GND] and check that the HP 37717C
Pattern Loss and Signal Loss indicators are not lit.

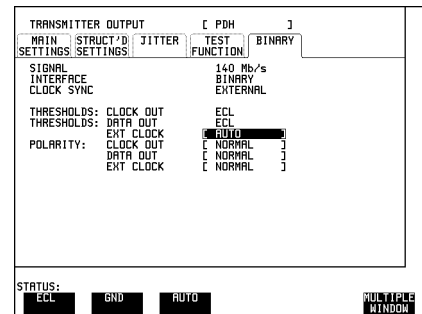

External Clock Mark to Space Ratio

1. Recall the HP 37717C DEFAULT SETTINGS as shown on 3-2.
2. Connect up the equipment as shown in Figure 3-56.

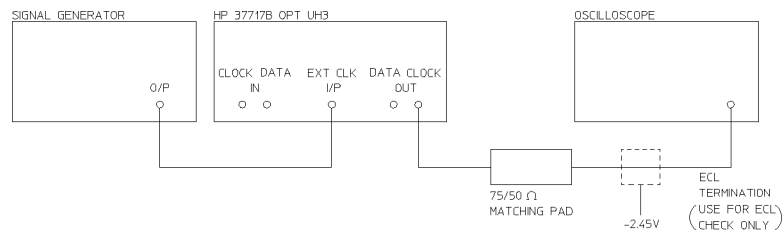

Figure 3-56

Mark to Space Ratio

Performance Tests

PDH Binary Interfaces (Option UH3, [US7])

Unstructured PDH Option UKK [USB]

3. Press **TRANSMIT** **PDH** **MAIN** **SETTINGS** and set up the display as shown opposite.

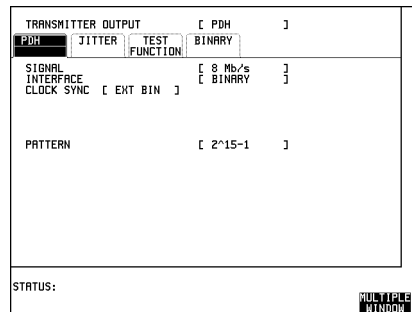

4. Press **TRANSMIT** **PDH** **BINARY** and set up the display as shown opposite.

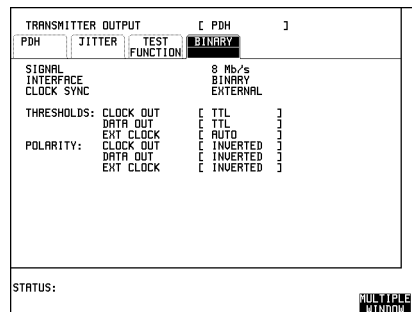

5. Set the Signal Generator to Frequency - 700 kHz, Output Level - 500 mV and connect to the EXT CLOCK input port of the binary interfaces module.

6. Connect the HP 37717C binary CLOCK O/P to the oscilloscope via the 75Ω/50Ω matching pad and check that the mark/space ratio of the displayed clock waveform is between 60/40 and 40/60.

7. Press **TRANSMIT** **PDH** **MAIN** **SETTINGS** and set up the display as shown opposite.

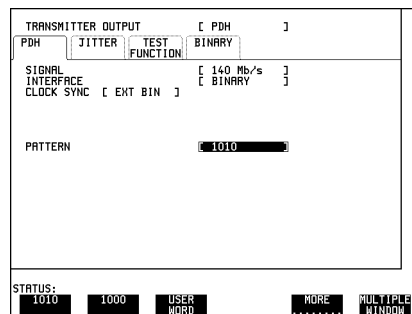

Performance Tests

PDH Binary Interfaces (Option UH3, [US7])

8. Press **TRANSMIT** **PDH** **BINARY** and set up the display as shown opposite.

9. Set the Signal Generator to Frequency - 170 MHz, Output Level - 500 mV and connect to the EXT CLOCK input port of the binary interfaces module.

10. Connect the HP 37717C binary CLOCK O/P to the oscilloscope via the 75Ω/50Ω matching pad and the ECL termination and check that the mark/space ratio of the displayed clock waveform is between 60/40 and 40/60.

TRANSMITTER OUTPUT		[PDH]
PDH	JITTER	TEST FUNCTION
SIGNAL INTERFACE		140 Mb/s
CLOCK SYNC		BINARY EXTERNAL
THRESHOLDS:	CLOCK OUT	[ECL]
THRESHOLDS:	DATA OUT	[ECL]
	EXT CLOCK	[AUTO]
POLARITY:	CLOCK OUT	[INVERTED]
	DATA OUT	[INVERTED]
	EXT CLOCK	[NORMAL]
STATUS:		MULTIPLE WINDOW

Structured PDH Option UKJ [USA]

1. Press **TRANSMIT** **PDH** **MAIN SETTINGS** and set up the display as shown opposite.

TRANSMITTER OUTPUT		[PDH]
MAIN SETTINGS	STRUCT'D SETTINGS	JITTER TEST FUNCTION
SIGNAL INTERFACE		[2 Mb/s]
CLOCK SYNC		[EXT BIN]
PAYLOAD TYPE		[UNFRAMED]
PATTERN		[2 ¹⁵ -1 PRBS]
PRBS POLARITY		[INV] CCITT
STATUS:		MULTIPLE WINDOW

2. Press **TRANSMIT** **PDH** **BINARY** and set up the display as shown opposite.

3. Set the Signal Generator to Frequency - 1.843 MHz, Output Level - 500 mV and connect to the EXT CLOCK input port of the binary interfaces module.

4. Connect the HP 37717C binary CLOCK O/P to the oscilloscope via the 75Ω/50Ω matching pad and check that the mark/space ratio of the displayed clock waveform is between 60/40 and 40/60.

TRANSMITTER OUTPUT		[PDH]
MAIN SETTINGS	STRUCT'D SETTINGS	JITTER TEST FUNCTION
SIGNAL INTERFACE		2 Mb/s
CLOCK SYNC		BINARY EXTERNAL
THRESHOLDS:	CLOCK OUT	[TTL]
THRESHOLDS:	DATA OUT	[TTL]
	EXT CLOCK	[AUTO]
POLARITY:	CLOCK OUT	[INVERTED]
	DATA OUT	[INVERTED]
	EXT CLOCK	[NORMAL]
STATUS:		MULTIPLE WINDOW

5. Repeat steps 3 and 4 with the Signal Generator frequency set to 2.253 MHz.

Performance Tests

PDH Binary Interfaces (Option UH3, [US7])

6. Select SIGNAL [8 Mb/s] and repeat 3 and 4 with the Signal Generator frequency set to 7.6 MHz and 9.29 MHz in turn.
7. Select SIGNAL [34 Mb/s] and repeat 3 and 4 with the Signal Generator frequency set to 30.93 MHz and 37.8 MHz in turn.
8. Press **TRANSMIT** **PDH** **MAIN** **SETTINGS** and set up the display as shown opposite.

TRANSMITTER OUTPUT		[PDH]
MAIN	STRUCT'D	JITTER
SETTINGS	SETTINGS	TEST FUNCTION
SIGNAL		[140 Mb/s]
INTERFACE		[BINARY]
CLOCK SYNC	[EXT BIN]	
PAYLOAD TYPE		[UNFRAMED]
PATTERN		[1010]
STATUS:		
MULTIPLE WINDOW		

9. Press **TRANSMIT** **PDH** **BINARY** and set up the display as shown opposite.

TRANSMITTER OUTPUT		[PDH]
MAIN	STRUCT'D	JITTER
SETTINGS	SETTINGS	TEST FUNCTION
SIGNAL		140 Mb/s
INTERFACE		BINARY
CLOCK SYNC		EXTERNAL
THRESHOLDS:	CLOCK OUT	ECL
THRESHOLDS:	DATA OUT	ECL
POLARITY:	EXT CLOCK	[AUTO]
	CLOCK OUT	[INVERTED]
	DATA OUT	[INVERTED]
	EXT CLOCK	[NORMAL]
STATUS:		
MULTIPLE WINDOW		

10. Set the Signal Generator to Frequency-125.3 MHz, Output Level - 500 mV and connect to the EXT CLOCK input port of the binary interfaces module.
11. Connect the HP 37717C binary CLOCK O/P to the oscilloscope via the 75Ω/50Ω matching pad and the ECL termination and check that the mark/space ratio of the displayed clock waveform is between 60/40 and 40/60.
12. Repeat steps 10 and 11 with the Signal Generator frequency set to 153.2 MHz

ETSI/ANSI Internal Transmitter Clock Rates (Option UKZ)

Specification

Rate	Frequency	Accuracy	Temperature Stability	Ageing Stability
DS1	1.544Mb/s	+/-0.7ppm @25C	<=3ppm (0 to +50C)	<=1ppm/Year
DS3	44.736Mb/s	+/-0.5ppm @25C	<=3ppm (0 to +50C)	<=1ppm/Year
E1	2.048Mb/s	+/-0.5ppm @25C	<=3ppm (0 to +50C)	<=1ppm/Year
E3	34.368Mb/s	+/-0.5ppm @25C	<=3ppm (0 to +50C)	<=1ppm/Year

Description

A frequency Counter terminated in 75 ohms and connected to the Option UKZ Transmit Module front panel Clock Out Port is used to verify the frequency accuracy of the transmitted data at all rates.

DS3 Frequency Accuracy

1. Recall the HP 37717C Default Settings as shown on 3-2.
2. Connect the Clock Output port on the HP 37717C Option UKZ Transmit Module to the Frequency Counter Channel A. Terminate in 75 ohm.
3. Adjust the Frequency Counter ATTEN and Trigger Level to obtain a stable reading and ensure that the frequency counter reading is between 44735798.6 Hz and 44736201.4 Hz
4. Select the HP 37717C TRANSMIT page, select PHYSICAL LAYER and set FREQUENCY OFFSET to [+20PPM].
5. Adjust the Frequency Counter ATTEN and Trigger Level to obtain a stable reading and ensure that the frequency counter reading is between 44736693.4 Hz and 44737096.0 Hz.
6. Set the FREQUENCY OFFSET to [-20PPM].

Performance Tests

ETSI/ANSI Internal Transmitter Clock Rates (Option UKZ)

7. Adjust the Frequency Counter ATTEN and Trigger Level to obtain a stable reading and ensure that the frequency counter reading is between 44734904.0 Hz and 44735306.6 Hz.

E1 (2.048Mb/s) Frequency Accuracy

1. Set the transmitter to Signal [E1 2Mb/s].
2. Adjust the Frequency Counter ATTEN and Trigger Level to obtain a stable reading and ensure that the frequency counter reading is between 2047985.6 Hz and 2048014.4Hz.
3. Set the FREQUENCY OFFSET to [USER OFFSET] [+50PPM].
4. Adjust the Frequency Counter ATTEN and Trigger Level to obtain a stable reading and ensure that the frequency counter reading is between 2048088 Hz and 2048116.8 Hz.
5. Set the FREQUENCY OFFSET to [USER OFFSET] [-50PPM].
6. Adjust the Frequency Counter ATTEN and Trigger Level to obtain a stable reading and ensure that the frequency counter reading is between 2047883.2 Hz and 2047912.0 Hz.

E3 (34.368Mb/s) Frequency Accuracy

1. Set the transmitter to Signal [E3 34Mb/s].
2. Adjust the Frequency Counter ATTEN and Trigger Level to obtain a stable reading and ensure that the frequency counter reading is between 34367759.4 Hz and 34368240.6 Hz.
3. Set the FREQUENCY OFFSET to [USER OFFSET] [+20PPM].
4. Adjust the Frequency Counter ATTEN and Trigger Level to obtain a stable reading and ensure that the frequency counter reading is between 34368446.8 Hz and 34368928 Hz.
5. Set the FREQUENCY OFFSET to [USER OFFSET] [-20PPM].
6. Adjust the Frequency Counter ATTEN and Trigger Level to obtain a stable reading and ensure that the frequency counter reading is between 34367072.0 Hz and 34367553.2 Hz.

DS1 Frequency Accuracy

1. Set the transmitter to Signal [DS1 1.5Mb/s].
2. Adjust the Frequency Counter ATTEN and Trigger Level to obtain a stable reading and ensure that the frequency counter reading is between 1543993 Hz and 1544007 Hz.
3. Set the FREQUENCY OFFSET to [+32PPM].
4. Adjust the Frequency Counter ATTEN and Trigger Level to obtain a stable reading and ensure that the frequency counter reading is between 1544042.4 Hz and 1544056.4 Hz.
5. Set the FREQUENCY OFFSET to [-32PPM].
6. Adjust the Frequency Counter ATTEN and Trigger Level to obtain a stable reading and ensure that the frequency counter reading is between 1543943.6 Hz and 1543957.6 Hz.

ETSI/ANSI Transmitter Output Level and Waveshape (Option UKZ)

Specifications

Rate	Frequency	Level	Waveshape
DSX-1	1.544Mb/s	3.0V +/-20%	Fits mask T1.102-1993
DS1-LO	1.544Mb/s		As DSX-1 with 655' ABAM Cable
DS3-HI	44.736Mb/s	0.9V pk (nominal)	
DSX-3	44.736Mb/s	560mV pk (nominal)	Fits mask T1.102-1993
DS3-900	44.736Mb/s	330mV pk (nominal)	
E1 (bal)	2.048Mb/s	3.00V +/-10%	As per ITU rec G703
E1 (unbal)	2.048Mb/s	2.37V +/-10%	As per ITU rec G703
E3	34.368Mb/s	1.0V +/-10%	As per ITU rec G703

Description

This test ensures the transmitter output level and pulse shape meet the required specifications at E1,E3,DS1 and DS3 rates. The Transmitter output is connected to an oscilloscope and the waveshape compared with the predefined masks stored in the oscilloscope memory. The signal levels are also measured using the oscilloscope.

34.368 Mb/s Positive Pulse

1. Recall the HP 37717C Default Settings as shown on 3-2.
2. Select the HP 37717C TRANSMIT page, select PHYSICAL LAYER and set as follows;

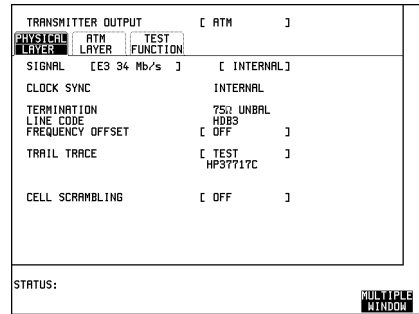

3. Select the HP 37717C TRANSMIT page, select ATM LAYER and set as follows;

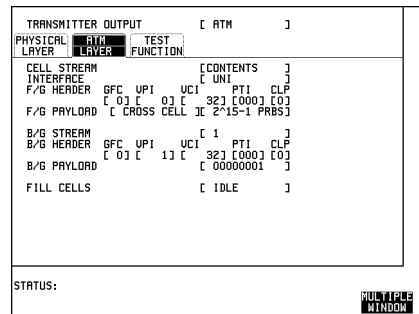

4. Connect the Transmit Module (Option UKZ) 75 ohms Unbalanced Output to the Oscilloscope via the 75/50 ohm converter.
5. Select CHAN on the oscilloscope and set to 50 ohms input impedance, DC coupled.
6. Select CHANNEL 1 on the oscilloscope and select PROBE 2.45 (attenuation level to compensate for the 75/50 ohm converter).
7. If using the HP 54503A oscilloscope, use the following key sequence to select and store the correct Telecom Mask.
 - a. DEFINE MEAS key.
 - b. COMPARE softkey.
 - c. TEST ON softkey.
 - d. WFORM SAVE key.

Performance Tests

ETSI/ANSI Transmitter Output Level and Waveshape (Option UKZ)

- e. MASK CCITT G703 34Mb softkey.
 - f. STORE to M1 + M2 softkey.
 - g. STORE softkey.
8. Press the SHIFT key on the oscilloscope (colored blue), then MASK AUTO key then 1 key.

The oscilloscope will now automatically display and compare an isolated positive pulse from the HP 37717C with the limits in the selected Telecom Mask. A PASS message should appear on the oscilloscope display when completed.

NOTE

It may be necessary to visibly check the waveform fits the mask and manually adjust amplitude and offset parameters on the oscilloscope to obtain a PASS on the Mask.

9. Measure the peak pulse amplitude at the mid pulse-width using the oscilloscope and verify that this is between 900 mV and 1.100 Volts.

34.368 Mb/s Negative Pulse

1. Select the HP 37717C TRANSMIT page, select ATM LAYER and set as follows;

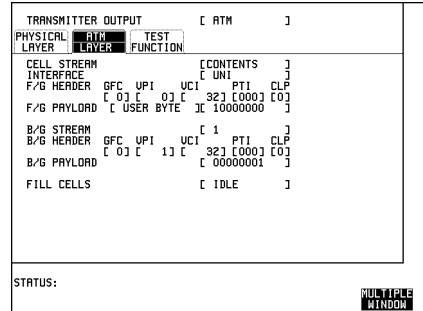

2. Select CHAN on the oscilloscope and set OFFSET to -500mV.
3. Select TRIG on the oscilloscope and set to PATTERN H X X X.
4. Select TIMEBASE on the Oscilloscope and set DELAY to 8nS. Adjust the delay manually until the negative pulse is centred on the oscilloscope display.
5. If using the HP 54503A oscilloscope, use the following key sequence to select and store the correct Telecom Mask.
 - a. WFORM SAVE key.
 - b. MASK CCITT G703 34Mb softkey.

Performance Tests

ETSI/ANSI Transmitter Output Level and Waveshape (Option UKZ)

- c. STORE to M1 + M2
- d. STORE INVERSE
6. Compare the isolated negative pulse from the HP 37717C with the limits in the selected Telecom Mask.
7. Ensure the waveform fits the mask.

NOTE

It may be necessary to visibly check the waveform fits the mask and manually adjust amplitude and offset parameters on the oscilloscope to obtain a PASS on the Mask.

8. Measure the peak pulse amplitude at the mid pulse-width using the oscilloscope and verify that this is between 900 mV and 1.100 Volts.

2.048 Mb/s Positive Pulse

1. Recall the HP 37717C Default Settings as shown on 3-2.
2. Select the HP 37717C TRANSMIT page, select PHYSICAL LAYER and set as follows;

TRANSMITTER OUTPUT		[ATM]
PHYSICAL LAYER	ATM	TEST
SIGNAL	[E1 2 Mb/s]	[INTERNAL]
CLOCK SYNC	INTERNAL	
TERMINATION	[75% UNBAL]	
LINE CODE	[HD83]	
FREQUENCY OFFSET	[OFF]	
CRC-4 MULTIFRAME	[OFF]	
CELL SCRAMBLING	[OFF]	
STATUS: OFF ON MULTIPLE WINDOW		

3. Select the HP 37717C TRANSMIT page, select ATM LAYER and set as follows;

TRANSMITTER OUTPUT		[ATM]
PHYSICAL LAYER	ATM	TEST
CELL STREAM INTERFACE	[CONTENTS]	
F/G HEADER	GFC UPI UCI	PTI CLP
F/G PAYLOAD	[0] [0] [32] [000] [0]	[2*15-1 PRBS]
B/G STREAM	[1]	
B/G HEADER	GFC UPI UCI	PTI CLP
B/G PAYLOAD	[0] [1] [32] [000] [0]	[00000001]
FILL CELLS	[IDLE]	
STATUS: MULTIPLE WINDOW		

Performance Tests

ETSI/ANSI Transmitter Output Level and Waveshape (Option UKZ)

4. Connect the UKZ Transmit Module 75 ohms Unbalanced Output to the Oscilloscope via the 75/50 ohm converter.
5. Select CHAN on the oscilloscope and set to 50 ohms input impedance, DC coupled.
6. Select CHANNEL 1 on the oscilloscope and select PROBE 2.45 (attenuation level to compensate for the 75/50 ohm converter).
7. If using the HP 54503A oscilloscope, use the following key sequence to select and store the correct Telecom Mask.
 - a. DEFINE MEAS key.
 - b. COMPARE softkey.
 - c. TEST ON softkey.
 - d. WFORM SAVE key.
 - e. MASK CCITT G703 DS1E 2.0 Mb softkey.
 - f. STORE to M1 + M2 softkey
 - g. STORE softkey
8. Press the SHIFT key on the oscilloscope (colored blue), then MASK AUTO key, then 1 key.

The oscilloscope will now automatically display and compare the isolated positive pulse from the HP 37717C with the limits in the selected Telecom Mask.

NOTE

It may be necessary to visibly check the waveform fits the mask and manually adjust amplitude and offset parameters on the oscilloscope to obtain a PASS on the Mask.

9. Measure the peak pulse amplitude at the mid pulse-width using the oscilloscope and verify that this is between 2.133V and 2.607V.

2.048 Mb/s Negative Pulse

1. Select the HP 37717C TRANSMIT page, select ATM LAYER and set as follow;

TRANSMITTER OUTPUT		[ATM]
PHYSICAL LAYER	[ATM]	TEST
REVERSE	[]	FUNCTION
CELL STREAM	[]	[CONTENTS]
INTERFACE	[]	[UNI]
F/G HEADER	[0] [0] [32] [000] [0]	[PT] [CLP]
F/G PAYLOAD	[USER BYTE]	[1000000]
B/G STREAM	[]	[]
B/G HEADER	[0] [1] [32] [000] [0]	[1] [PT] [CLP]
B/G PAYLOAD	[]	[00000001]
FILL CELLS	[]	[IDLE]
STATUS:		[]
		MULTIPLE WINDOW

2. Select CHAN on the oscilloscope and set OFFSET to -800mV.
3. Select TRIG on the oscilloscope and set to PATTERN H X X X.
4. Select TIMEBASE on the Oscilloscope and set DELAY to 126 nS. Adjust the delay manually until the negative pulse is centred on the oscilloscope display.
5. If using the HP 54503A oscilloscope, use the following key sequence to select and store the correct Telecom Mask.
 - a. WFORM SAVE key.
 - b. MASK CCITT G703 DS1E 2.0 Mb softkey.
 - c. STORE to M1 + M2.
 - e. STORE INVERSE.
6. Compare the isolated negative pulse from the HP 37717C with the limits in the selected Telecom Mask.
7. Ensure the waveform fits the mask.

NOTE

It may be necessary to visibly check the waveform fits the mask and manually adjust amplitude and offset parameters on the oscilloscope to obtain a PASS on the Mask.

8. Measure the peak pulse amplitude at the mid pulse-width using the oscilloscope and verify that this is between 2.133V and 2.607V.

ETSI/ANSI Transmitter Output Level and Waveshape (Option UKZ)

DSX-3 Positive Pulse

1. Recall the HP 37717C Default Settings as shown on 3-2.
2. Select the HP 37717C TRANSMIT page, select PHYSICAL LAYER and set as follows;

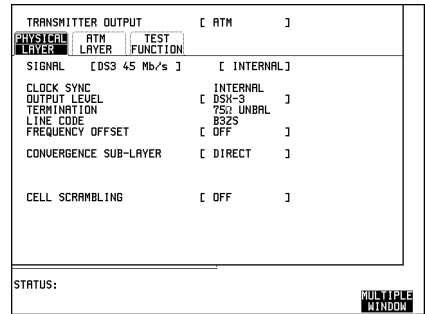

3. Select the HP 37717C TRANSMIT page, select ATM LAYER and set as follows;

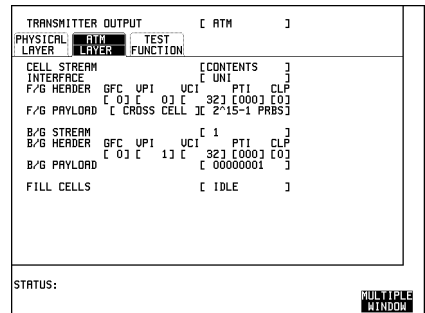

4. Connect the UKZ Transmit Module 75 ohms Unbalanced Output to the Oscilloscope via the 75/50 ohm converter.
5. Select CHAN on the oscilloscope and set to 50 ohms input impedance, DC coupled.
6. Select CHANNEL 1 on the oscilloscope and select PROBE 2.45 (attenuation level to compensate for the 75/50 ohm converter).
7. If using the HP 54503A oscilloscope, use the following key sequence to select and store the correct Telecom Mask.
 - a. DEFINE MEAS key.
 - b. COMPARE softkey.
 - c. TEST ON softkey.
 - d. WFORM SAVE key.

Performance Tests

ETSI/ANSI Transmitter Output Level and Waveshape (Option UKZ)

- e. MASK DS3 45 Mb ANSI T1.102 softkey.
 - f. STORE to M1 + M2 softkey.
 - g. STORE softkey.
8. Press the SHIFT key on the oscilloscope (colored blue), then MASK AUTO key, then 1 key.

The oscilloscope will now automatically display and compare the isolated positive pulse from the HP 37717C with the limits in the selected Telecom Mask.

NOTE

It may be necessary to visibly check the waveform fits the mask and manually adjust amplitude and offset parameters on the oscilloscope to obtain a PASS on the Mask.

DSX-3 Negative Pulse

1. Select the HP 37717C TRANSMIT page, select ATM LAYER and set as follows;

TRANSMITTER OUTPUT		[ATM]
PHYSICAL LAYER	[AUTO]	TEST
LAYER	[INVERSE]	FUNCTION
CELL STREAM	[]	[CONTENTS]
INTERFACE	[]	[UNI]
F/G HEADER	[GFC UPI UCI]	[PTI CLP]
	[0] [0] [32] [000] [0]	
F/G PAYLOAD	[USER BYTE]	[1000000]
B/G STREAM	[]	[]
B/G HEADER	[GFC UPI UCI]	[1 PTI CLP]
	[0] [1] [32] [000] [0]	
B/G PAYLOAD	[]	[00000001]
FILL CELLS	[]	[IDLE]
STATUS:		[]
		[MULTIPLE WINDOW]

2. Select CHAN on the oscilloscope and set OFFSET to -270 mV.
3. Select TRIG on the oscilloscope and set to PATTERN H X X X.
4. Select TIMEBASE on the Oscilloscope and set DELAY to -186 nS. Adjust the delay manually until the negative pulse is centred on the oscilloscope display.
5. If using the HP 54503A oscilloscope, use the following key sequence to select and store the correct Telecom Mask.
 - a. WFORM SAVE key.
 - b. MASK DS3 45 Mb ANSI T1.102 softkey.
 - c. STORE to M1 + M2.
 - d. STORE INVERSE.

Performance Tests

ETSI/ANSI Transmitter Output Level and Waveshape (Option UKZ)

6. Compare the isolated negative pulse from the HP 37717C with the limits in the selected Telecom Mask.
7. Ensure the waveform fits the mask.

NOTE

It may be necessary to visibly check the waveform fits the mask and manually adjust amplitude and offset parameters on the oscilloscope to obtain a PASS on the Mask.

DSX-1 Positive Pulse

1. Recall the HP 37717C Default Settings as shown on 3-2.

2. Select the HP 37717C TRANSMIT page, select PHYSICAL LAYER and set as follows;

TRANSMITTER OUTPUT		[ATM]
PHYSICAL LAYER	ATM LAYER	TEST FUNCTION
SIGNAL	[DS1 1.5 Mb/s]	[INTERNAL]
CLOCK SYNC		[INTERNAL]
OUTPUT LEVEL		[DSX-1]
TERMINATION		[100Ω BAL]
LINE CODE		[B8ZS]
FREQUENCY OFFSET		[OFF]
CELL SCRAMBLING		[OFF]

STATUS: MULTIPLE WINDOW

3. Select the HP 37717C TRANSMIT page, select ATM LAYER and set as follows;

TRANSMITTER OUTPUT		[ATM]
PHYSICAL LAYER	ATM LAYER	TEST FUNCTION
CELL STREAM INTERFACE		[CONTENTS]
F/G HEADER	[GFC] [UPI] [UCI] [PTI] [CLP]	
F/G PAYLOAD	[0] [0] [32] [000] [0]	[CROSS CELL] [2*15-1 PRBS]
B/G STREAM		[1]
B/G HEADER	[GFC] [UPI] [UCI] [PTI] [CLP]	
B/G PAYLOAD	[0] [1] [32] [000] [0]	[00000001]
FILL CELLS		[IDLE]

STATUS: MULTIPLE WINDOW

4. Connect the UKZ Transmit Module 100 ohm Balanced Output to the Oscilloscope via the HP 15508B Balanced to unbalanced Converter and HP 11852B 75/50 ohm converter.
5. Select CHAN on the oscilloscope and set to 50 ohms input impedance, DC coupled.

Performance Tests

ETSI/ANSI Transmitter Output Level and Waveshape (Option UKZ)

6. Select CHANNEL 1 on the oscilloscope and select PROBE 2.45 (attenuation level to compensate for the 75/50 ohm converter).
7. If using the HP 54503A oscilloscope, use the following key sequence to select and store the correct Telecom Mask.
 - a. DEFINE MEAS key.
 - b. COMPARE softkey.
 - c. TEST ON softkey.
 - d. WFORM SAVE key.
 - e. MASK DS1 new 1.5 Mb ANSI T1.102 softkey.
 - f. STORE to M1 + M2 softkey.
 - g. STORE softkey.
8. Press the SHIFT key on the oscilloscope (colored blue), then MASK AUTO key, then 1 key.

The oscilloscope will now automatically display and compare the isolated positive pulse from the HP 37717C with the limits in the selected Telecom Mask.

NOTE

It may be necessary to visibly check the waveform fits the mask and manually adjust amplitude and offset parameters on the oscilloscope to obtain a PASS on the Mask.

9. Measure the peak pulse amplitude at the mid pulse-width using the oscilloscope and verify that this is between 1.984V and 2.976V.

DSX-1 Negative Pulse

1. Select the HP 37717C TRANSMIT page, select ATM LAYER and set as follows;

TRANSMITTER OUTPUT	[ATM]
PHYSICAL LAYER	[AUTO]
TEST	[TEST]
REVERSE	[FUNCTION]
CELL STREAM	[CONTENTS]
INTERFACE	[UNI]
F/G HEADER	[GFC UPI UCI PTI CLP]
F/G PAYLOAD	[0] [0] [32] [000] [0]
	[USER BYTE] [1000000]
B/G STREAM	[1]
B/G HEADER	[GFC UPI UCI PTI CLP]
B/G PAYLOAD	[0] [1] [32] [000] [0]
	[00000001]
FILL CELLS	[IDLE]
STATUS:	
MULTIPLE WINDOW	

Performance Tests

ETSI/ANSI Transmitter Output Level and Waveshape (Option UKZ)

2. Select CHAN on the oscilloscope and set OFFSET to -390 mV.
3. Select TRIG on the oscilloscope and set to PATTERN H X X X.
4. Select TIMEBASE on the Oscilloscope and set DELAY to 300 nS. Adjust the delay manually until the negative pulse is centred on the oscilloscope display.
5. If using the HP 54503A oscilloscope, use the following key sequence to select and store the correct Telecom Mask.
 - a. WFORM SAVE key.
 - b. MASK DS1 new 1.5 Mb ANSI T1.102 softkey.
 - c. STORE to M1 + M2.
 - e. STORE INVERSE.
6. Compare the isolated negative pulse from the HP 37717C with the limits in the selected Telecom Mask.
7. Ensure the waveform fits the mask.

NOTE

It may be necessary to visibly check the waveform fits the mask and manually adjust amplitude and offset parameters on the oscilloscope to obtain a PASS on the Mask.

8. Measure the peak pulse amplitude at the mid pulse-width using the oscilloscope and verify that this is between 1.984V and 2.976V.

ETSI/ANSI Receiver Equalization (Option UKZ)

Specifications

Bit Rate	Cable Loss Accommodation
2.048Mb/s	Up to 6dB for root f cable @ half-bit rate
34.368Mb/s	Automatic equalization up to 12dB for root f cable @ half-bit rate
1.544Mb/s (DS1)	Signal range from DS1-LO to DSX-1
44.736Mb/s (DS3)	Automatic equalization for up to 900 feet of type 728A Cable (root f)

Description

The Receiver Equalization is checked by looping the transmitter output to receiver input through a special Cable Simulator. This device is designed to simulate the specified cable loss at the rate under test. A BER measurement is run and a check made for no errors in the results page.

2.048Mb/s Equalization

1. Recall the HP 37717C Default Settings as shown on 3-2.
2. Press OTHER key, then SETTINGS CONTROL softkey, then set the TRANSMITTER and RECEIVER to COUPLED.
3. Select the HP 37717C TRANSMIT page, select PHYSICAL LAYER and set as follows;

TRANSMITTER OUTPUT	[ATM]
PHYSICAL LAYER	[TEST]
SIGNAL	[E1 2 Mb/s]
CLOCK SYNC	[INTERNAL]
TERMINATION	[75Ω UNBAL]
LINE CODE	[HDB3]
FREQUENCY OFFSET	[OFF]
CRC-4 MULTIFRAME	[OFF]
CELL SCRAMBLING	[ON]
STATUS:	
MULTIPLE WINDOW	

Performance Tests

ETSI/ANSI Receiver Equalization (Option UKZ)

4. Connect Cable Simulator #5 (see Recommended Test Equipment Table in Chapter 1) between the HP 37717C Transmitter Output and Receiver Input ports.
5. Press RESULTS [TROUBLE SCAN] , then RUN/STOP key to start the measurement.
6. Ensure that NO TROUBLE is displayed on the RESULTS page after 30 seconds.
7. Press RUN/STOP key to stop the measurement.

34.368 Mb/s Equalization

1. Select the HP 37717C TRANSMIT page, select PHYSICAL LAYER and set as follows;

TRANSMITTER OUTPUT	[ATM]
PHYSICAL LAYER	TEST FUNCTION
SIGNAL [E3 34 Mb/s]	[INTERNAL]
CLOCK SYNC [INTERNAL]	
TERMINATION	75Ω UNBAL
LINE CODE	HDB3
FREQUENCY OFFSET	[OFF]
TRAIL TRACE	[TEST HP37717C]
CELL SCRAMBLING	[ON]
STATUS:	
MULTIPLE WINDOW	

2. Connect Cable Simulator #6 (see “Recommended Test Equipment” in Chapter 1 on Page 67) between the HP 37717C Transmitter Output and Receiver Input ports.
3. Press RESULTS [TROUBLE SCAN] , then RUN/STOP key to start the measurement.
4. Ensure that NO TROUBLE is displayed on the RESULTS page after 30 seconds.
5. Press RUN/STOP key to stop the measurement.

Performance Tests

ETSI/ANSI Receiver Equalization (Option UKZ)

DS3 Equalization

1. Recall the HP 37717C Default Settings as shown on 3-2.
2. Select the HP 37717C TRANSMIT page, select PHYSICAL LAYER and set as follows;

PHYSICAL LAYER	ATH	TEST FUNCTION
TRANSMITTER OUTPUT	[ATM]	[]
SIGNAL	[DS3 45 Mb/s]	[INTERNAL]
CLOCK SYNC		[INTERNAL]
OUTPUT LEVEL	[DSX-3]	[]
TERMINATION	[75Ω UNBAL]	[]
LINE CODE	[B3ZS]	[]
FREQUENCY OFFSET	[OFF]	[]
CONVERGENCE SUB-LAYER	[DIRECT]	[]
CELL SCRAMBLING	[ON]	[]

STATUS: MULTIPLE WINDOW

3. Connect Cable Simulator #5 (see “Recommended Test Equipment” in Chapter 1 on Page 67) between the HP 37717C UKZ Unbalanced Transmitter Output and Receiver Input ports.

NOTE

If Cable Simulator #5 is not available, it is permissible to select DS3-900' on the Transmitter Page and connect the HP 37717C UKZ Unbalanced Transmitter Output port direct to the Receiver Input port. This setup assumes the DS3-900' output signal is within specification.

4. Press RESULTS [TROUBLE SCAN] , then RUN/STOP key to start the measurement.
5. Ensure that NO TROUBLE is displayed on the RESULTS page after 30 seconds.
6. Press RUN/STOP key to stop the measurement.

Performance Tests
ETSI/ANSI Receiver Equalization (Option UKZ)

DS1 Equalization

1. Recall the HP 37717C Default Settings as shown on 3-2.
2. Select the HP 37717C TRANSMIT page, select PHYSICAL LAYER and set as follows;

TRANSMITTER OUTPUT		[ATM]
PHYSICAL LAYER	ATH	TEST FUNCTION
SIGNAL	[DS1 1.5 Mb/s]	[INTERNAL]
CLOCK SYNC		INTERNAL
OUTPUT LEVEL		[DSX-1]
TERMINATION		[100Ω BAL]
LINE CODE		B8ZS
FREQUENCY OFFSET		[OFF]
CELL SCRAMBLING		[OFF]

STATUS: MULTIPLE WINDOW

3. Connect Cable Simulator #6 (see “Recommended Test Equipment” in Chapter 1 on Page 67) between the HP 37717C Transmitter Balanced Output and Receiver Balanced Input ports via two Balanced to Unbalanced Converters (HP 15508B).

NOTE

If Cable Simulator #6 is not available, it is permissible to select DS1-LO on the Transmitter Page and connect the HP 37717C UKZ Unbalanced Transmitter Output port direct to the Receiver Input port. This setup assumes the DS1-LO output signal is within specification.

4. Press RESULTS [TROUBLE SCAN] , then RUN/STOP key to start the measurement.
5. Ensure that NO TROUBLE is displayed on the RESULTS page after 30 seconds.
6. Press RUN/STOP key to stop the measurement.

ETSI/ANSI Receiver Monitor Levels (Option UKZ)

Specifications

Bit Rate	Cable Loss Accommodation (Monitor mode)	Monitor Gain
2.048Mb/s (Unbalanced Mode)	Selectable OFF or Automatic (Up to 6dB for root f cable @ half-bit rate).	Selectable 20dB, 26dB or 30dB
2.048Mb/s (Balanced Mode)	Selectable OFF or Automatic - Up to 6dB (20dB selected) or 3dB (26 or 30dB selected) for root f cable @ half-bit rate .	Selectable 20dB, 26dB or 30dB
34.368Mb/s	Selectable OFF or Automatic (Up to 12dB for root f cable @ half-bit rate)	Selectable 20dB or 26dB
1.544Mb/s (DS1)	Signal range from DS1-LO to DSX-1	Selectable 20dB, 26dB or 30dB
44.736Mb/s (DS3)	Selectable OFF or Automatic (Up to 900 feet of type 728A Cable (root f)	Selectable 20dB or 26dB

Description

The Receiver Monitor capability is checked by looping the transmitter output to receiver input through a series of matching pads and selectable fixed attenuators. The total attenuation of this loop is calculated to be the same as the selected Monitor attenuation. A BER measurement is run and a check made for no errors in the results page for each selection of Bit Rate and monitor attenuation.

ETSI/ANSI Receiver Monitor Levels (Option UKZ)

2.048Mb/s 20dB Monitor

1. Recall the HP 37717C Default Settings as shown on 3-2.

2. Select the HP 37717C TRANSMIT page, select PHYSICAL LAYER and set as follows;

TRANSMITTER OUTPUT		[ATM]]
PHYSICAL LAYER	ATM TEST		
SIGNAL	[E1 2 Mb/s]	[INTERNAL]	
CLOCK SYNC		INTERNAL	
TERMINATION		[75Ω UNBAL]]
LINE CODE		[HDB3]]
FREQUENCY OFFSET		[OFF]]
CRC-4 MULTIFRAME		[OFF]]
CELL SCRAMBLING		[ON]]
STATUS:			
			MULTIPLE WINDOW

3. Select the HP 37717C RECEIVE page, select PHYSICAL LAYER and set as follows;

RECEIVER INPUT		[ATM]]
PHYSICAL LAYER	ATM TRIGGERS		
SIGNAL		[E1 2 Mb/s]]
TERMINATION		[75Ω UNBAL]]
LINE CODE		[HDB3]]
LEVEL		[MONITOR]]
CRC-4 MULTIFRAME	GAIN	[20 dB]]
		[OFF]]
CELL SCRAMBLING		[ON]]
STATUS:			
			MULTIPLE WINDOW

4. Connect the equipment as shown in Figure 3-57 below (no attenuation in the additional Attenuation position).
5. Press RESULTS [TROUBLE SCAN] , then RUN/STOP key to start the measurement.
6. Ensure that NO TROUBLE is displayed on the RESULTS page after 30 seconds.
7. Press RUN/STOP key to stop the measurement.

ETSI/ANSI Receiver Monitor Levels (Option UKZ)

2.048Mb/s 26dB Monitor

8. Connect a fixed 6dB Attenuator in the Additional Attenuation position of the circuit of Figure 3-57.
9. Set the HP 37717C MONITOR GAIN to 26dB mode.
10. Press RESULTS [TROUBLE SCAN] , then RUN/STOP key to start the measurement.
11. Ensure that NO TROUBLE is displayed on the RESULTS page after 30 seconds.
12. Press RUN/STOP key to stop the measurement.

2.048Mb/s 30dB Monitor

13. Connect a fixed 6dB attenuator and a fixed 3dB Attenuator in the Additional Attenuation position of the circuit of Figure 3-57.
14. Set the HP 37717C MONITOR GAIN to 30dB mode.
15. Press RESULTS [TROUBLE SCAN] , then RUN/STOP key to start the measurement.
16. Ensure that NO TROUBLE is displayed on the RESULTS page after 30 seconds.
17. Press RUN/STOP key to stop the measurement.

34.368 Mb/s 20dB Monitor

1. Recall the HP 37717C Default Settings as shown on 3-2.
2. Select the HP 37717C TRANSMIT page, select PHYSICAL LAYER and set as follows;

TRANSMITTER OUTPUT	[ATM]
PHYSICAL LAYER	ATM TEST FUNCTION
SIGNAL	[E3 34 Mb/s] [INTERNAL]
CLOCK SYNC	[INTERNAL]
TERMINATION	75Ω UNBAL
LINE CODE	HDB3
FREQUENCY OFFSET	[OFF]
TRAIL TRACE	[TEST HP37717C]
CELL SCRAMBLING	[ON]
STATUS:	
MULTIPLE WINDOW	

Performance Tests

ETSI/ANSI Receiver Monitor Levels (Option UKZ)

3. Select the HP 37717C RECEIVE page, select PHYSICAL LAYER and set as follows;

RECEIVER INPUT	[ATM]
PHYSICAL LAYER	ATM TRIGGERS
SIGNAL	[E3 34 Mb/s]
TERMINATION	75Ω UNBAL
LINE CODE	HDB3
LEVEL	[MONITOR]
EQUALIZER	[OFF] GAIN [20 dB]
CELL SCRAMBLING	[ON]
STATUS:	
MULTIPLE WINDOWS	

4. Connect the equipment as shown in Figure 3-57 below (no attenuation in the additional Attenuation position).
5. Press RESULTS [TROUBLE SCAN] , then RUN/STOP key to start the measurement.
6. Ensure that NO TROUBLE is displayed on the RESULTS page after 30 seconds.
7. Press RUN/STOP key to stop the measurement.

34.368 Mb/s 26dB Monitor

8. Connect a fixed 6dB Attenuator in the Additional Attenuation position of the circuit of Figure 3-57.
9. Set the HP 37717C MONITOR GAIN to 26dB mode.
10. Press RESULTS [TROUBLE SCAN] , then RUN/STOP key to start the measurement.
11. Ensure that NO TROUBLE is displayed on the RESULTS page after 30 seconds.
12. Press RUN/STOP key to stop the measurement.

Performance Tests
ETSI/ANSI Receiver Monitor Levels (Option UKZ)

DS3 20dB Monitor

1. Recall the HP 37717C Default Settings as shown on 3-2.
2. Select the HP 37717C TRANSMIT page, select PHYSICAL LAYER and set as follows;

TRANSMITTER OUTPUT		[ATM]]
PHYSICAL LAYER	ATM	TEST	FUNCTION
SIGNAL	[DS3 45 Mb/s]		[INTERNAL]
CLOCK SYNC			INTERNAL
OUTPUT LEVEL			[DSX-3]
TERMINATION			75Ω UNBAL
LINE CODE			B3ZS
FREQUENCY OFFSET			[OFF]
CONVERGENCE SUB-LAYER			[DIRECT]
CELL SCRAMBLING			[ON]

STATUS: MULTIPLE WINDOW

3. Select the HP 37717C RECEIVE page, select PHYSICAL LAYER and set as follows;

RECEIVER INPUT		[ATM]]
PHYSICAL LAYER	ATM	TRIGGERS	
SIGNAL	[DS3 45 Mb/s]		
TERMINATION			75Ω UNBAL
LINE CODE			B3ZS
LEVEL			[MONITOR]
EQUALIZER	[OFF]	GAIN	[20 dB]
CONVERGENCE SUB-LAYER			[DIRECT]
CELL SCRAMBLING			[ON]

STATUS: MULTIPLE WINDOW

4. Connect the equipment as shown in Figure 3-57 below (no attenuation in the additional Attenuation position).
5. Press RESULTS [TROUBLE SCAN] , then RUN/STOP key to start the measurement.
6. Ensure that NO TROUBLE is displayed on the RESULTS page after 30 seconds.
7. Press RUN/STOP key to stop the measurement.

DS3 26dB Monitor

8. Connect a fixed 6dB Attenuator in the Additional Attenuation position of the circuit of Figure 3-57.
9. Set the HP 37717C MONITOR GAIN to 26dB mode.

Performance Tests

ETSI/ANSI Receiver Monitor Levels (Option UKZ)

10. Press RESULTS [TROUBLE SCAN] , then RUN/STOP key to start the measurement.
11. Ensure that NO TROUBLE is displayed on the RESULTS page after 30 seconds.
12. Press RUN/STOP key to stop the measurement.

DS1 20dB Monitor

1. Recall the HP 37717C Default Settings as shown on 3-2.
2. Select the HP 37717C TRANSMIT page, select PHYSICAL LAYER and set as follows;

TRANSMITTER OUTPUT		[ATM]
PHYSICAL LAYER	ATM	TEST FUNCTION
SIGNAL	[DS1 1.5 Mb/s]	[INTERNAL]
CLOCK SYNC		INTERNAL
OUTPUT LEVEL		[DSX-1]
TERMINATION		[100Ω BAL]
LINE CODE		[8B2S]
FREQUENCY OFFSET		[OFF]
CELL SCRAMBLING	[ON]	[]
STATUS:		MULTIPLE WINDOW

3. Select the HP 37717C RECEIVE page, select PHYSICAL LAYER and set as follows;

RECEIVER INPUT		[ATM]
PHYSICAL LAYER	ATM	TRIGGERS
SIGNAL	[DS1 1.5 Mb/s]	
TERMINATION		[100Ω BAL]
LINE CODE		[8B2S]
LEVEL		[MONITOR]
	GAIN	[20 dB]
CELL SCRAMBLING	[ON]	[]
STATUS:		MULTIPLE WINDOW

4. Connect the equipment as shown in Figure 3-57 below, but use the Balanced DS1 output and input ports on the HP 37717C connected via two 110/75 ohm bal to Unbal converters.
5. Press RESULTS [TROUBLE SCAN] , then RUN/STOP key to start the measurement.
6. Ensure that NO TROUBLE is displayed on the RESULTS page after 30 seconds.
7. Press RUN/STOP key to stop the measurement.

Performance Tests

ETSI/ANSI Receiver Monitor Levels (Option UKZ)

DS1 26dB Monitor

8. Connect a fixed 6dB Attenuator in the Additional Attenuation position of the circuit of Figure 3-57.
9. Set the HP 37717C MONITOR GAIN to 26dB mode.
10. Press RESULTS [TROUBLE SCAN] , then RUN/STOP key to start the measurement.
11. Ensure that NO TROUBLE is displayed on the RESULTS page after 30 seconds.
12. Press RUN/STOP key to stop the measurement.

DS1 30dB Monitor

13. Connect a fixed 6dB Attenuator and a fixed 3dB Attenuator in the Additional Attenuation position of the circuit of Figure 3-57.
14. Set the HP 37717C MONITOR GAIN to 30dB mode.
15. Press RESULTS [TROUBLE SCAN] , then RUN/STOP key to start the measurement.
16. Ensure that NO TROUBLE is displayed on the RESULTS page after 30 seconds.
17. Press RUN/STOP key to stop the measurement.

Trigger Output (Option UKZ)

Specification

Output available on selected receive errors.
Pulse level: TTL, (typical)

Description

This is a functional check of the Option UKZ Receive Module Trigger Port as this has supplemental specifications only and does not require a full Performance test. The HP 37717C is set up to generate and receive an errored PDH signal. A frequency Counter terminated in 75 ohms and connected to the option UKZ Receive Module front panel Trigger Out Port is used to verify the presence of pulses at the appropriate received error rate.

Trigger Pulse

1. Recall the HP 37717C Default Settings as shown on 3-2.
2. Select the HP 37717C TRANSMIT page, select PHYSICAL LAYER and set as follows;

TRANSMITTER OUTPUT			[ATM]
PHYSICAL LAYER	ATM LAYER	TEST FUNCTION	
SIGNAL	[E3 34 Mb/s]		[INTERNAL]
CLOCK SYNC	[INTERNAL]		
TERMINATION		75Ω UNBAL	
LINE CODE		8B3	
FREQUENCY OFFSET		[OFF]	
TRAIL TRACE		[TEST HP37717C]	
CELL SCRAMBLING		[ON]	

STATUS: MULTIPLE WINDOW

Performance Tests

Trigger Output (Option UKZ)

3. Select the HP 37717C TRANSMIT page, select TEST FUNCTION and set as follows;

TRANSMITTER OUTPUT		[ATM]
PHYSICAL LAYER	ATM LAYER	TEST FUNCTION
TEST FUNCTION [ATM PAYLD] ERR & ALARM		
ERROR ADD TYPE	STREAM	[SINGLE HEC]
	RATE	[1E-3]
DAM ALARM TYPE		[OFF]
STATUS:		
MULTIPLE WINDOW		

4. Select the HP 37717C RECEIVE page, select PHYSICAL LAYER and set as follows;

RECEIVER INPUT		[ATM]
PHYSICAL LAYER	ATM LAYER	TRIGGERS
SIGNAL [E3 34 Mb/s]		
TERMINATION	75Ω UNBAL	
LINE CODE	HDB3	
LEVEL	[TERMINATE]	
CELL SCRAMBLING		[ON]
STATUS:		
MULTIPLE WINDOW		

5. Select the HP 37717C RECEIVE page, select TRIGGERS and set as follows;

RECEIVER INPUT		[ATM]
PHYSICAL LAYER	ATM LAYER	TRIGGERS
ERROR SELECTED FOR TRIGGER CORR HEC		
STATUS:		
NONE	CORR HEC	NCORR HEC
ERR CELLS	MULTIPLE WINDOW	

6. Connect the Transmit Module (Option UKZ) 75 ohms Unbalanced Output to the Receive Module (Option UKZ) 75 ohms Unbalanced Input.

7. Connect the Trigger Output port on the Receive Module (Option UKZ) to the Oscilloscope Channel A. Terminate in 75 ohm.

8. Press AUTOSCALE on the Oscilloscope and ensure the displayed Trigger Output pulse has TTL levels.

Performance Tests
Trigger Output (Option UKZ)

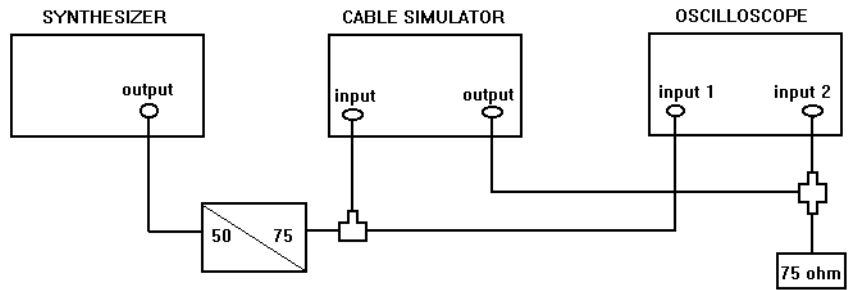

Figure 3-57 Monitor Input Test Setup

Internal SONET Transmitter Clock (Option 120)

Specification

Bit Rate	Accuracy
155.52 Mb/s	± 4.5 ppm

Description

The test uses a Frequency Counter connected to the SDH/SONET Signal Out port to measure the STS-3 All Ones data rate. This gives an indirect measure of the transmitter clock frequency as the data is clocked by the internal 10MHz clock oscillator. The test limits assume the instrument is within the annual calibration cycle. The STS-3 Framing is disabled for this test using the MODULE DEBUG function of the HP 37717C.

Equipment Required

Frequency Counter	: HP 5335A Option 010
75Ω Termination	: HP 15522-80010
T Connector	: HP 1250-0781

Procedure

1. Recall the HP 37717C DEFAULT SETTINGS as shown on 3-2.
2. Connect the HP 37717C OUT port to the Frequency Counter Input A, terminated in 75 Ω (use the T Connector).

Performance Tests

Internal SONET Transmitter Clock (Option 120)

3. Press **TRANSMIT** **SONET** and set up the display as shown opposite.

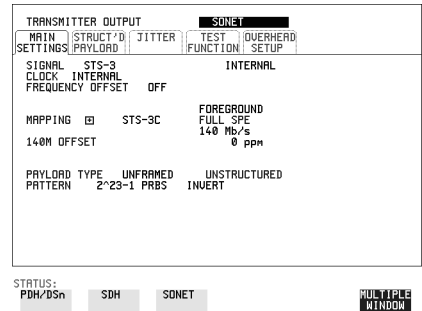

4. Make the following key sequence on the HP 37717C to obtain the special **MODULE DEBUG** display.

Press **OTHER**; **←**; **MORE**; **←**;
MORE; **←**; **MORE**; **OTHER**.

Press **MORE** until **MODULE DEBUG** appears in the softkey menu.

Press **MODULE DEBUG** and set up the display as shown opposite.

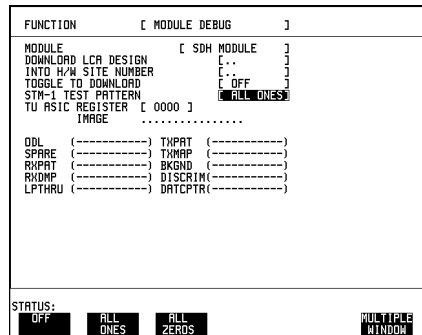

CAUTION

When using the **MODULE DEBUG** display, ONLY modify the STM-1 TEST PATTERN. Altering other parameters can damage instrument firmware - exit this display after setup to eliminate any possibility of accidental modification.

5. Adjust the Frequency Counter Trigger Level to obtain a stable reading and ensure that the Frequency Counter reads between 77.759650 MHz and 77.760350 MHz.

6. Disconnect all the test equipment.

SONET Frequency Offsets (Option 120)

Specifications

Range	±999 ppm
Resolution	0.1 ppm
Accuracy	0.02 ppm

Description

The SONET Transmitter Offset Clock is checked for range and accuracy using a Frequency Counter to measure the STS-3 Data rate. This gives an indirect measure of the transmitter clock frequency as the data is clocked by the internal 10MHz clock oscillator. A measurement with no offset is performed to establish a reference Clock frequency. The frequency accuracy is then measured over the specified offset range. The STS-3 Framing is disabled during this test using the **MODULE DEBUG** function of the HP 37717C.

Equipment Required

Frequency Counter	: HP 5335A Opt 010
T Connector	: HP 1250-0781

Procedure

1. Recall the HP 37717C DEFAULT SETTINGS as shown on 3-2.
2. Connect the OUT port to the Frequency Counter terminated in 75 Ω (use the T connector).

Performance Tests

SONET Frequency Offsets (Option 120)

3. Press **TRANSMIT** and set up the display as shown opposite.

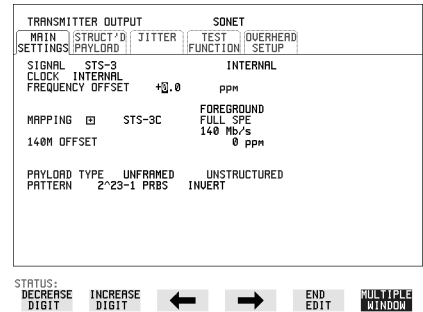

4. Make the following key sequence on the HP 37717C to obtain the special **MODULE DEBUG** display.

Press **OTHER**; **←**; **MORE**; **←**;
MORE; **←**; **MORE**; **OTHER**.

Press **MORE** until **MODULE DEBUG** appears in the softkey menu.

Press **MODULE DEBUG** and set up the display as shown opposite.

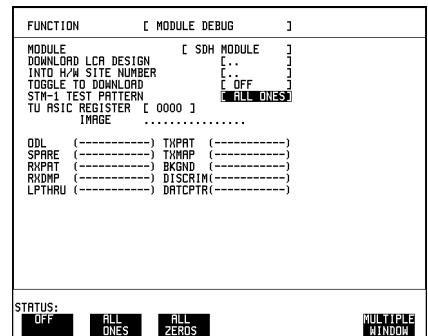

CAUTION

When using the **MODULE DEBUG** display, **ONLY** modify the STM-1 TEST PATTERN. Altering other parameters can damage instrument firmware - exit this display after setup to eliminate any possibility of accidental modification.

- Adjust the Frequency Counter Trigger Level to obtain a stable reading.
- Take note of the measured frequency (MF).
- Select the frequency offset settings given in Table 3-9 and verify the frequency at each step against the measured frequency (MF) noted in step 6.

SONET Frequency Offsets (Option 120)**Table 3-9 Measured Offset**

Offset (ppm)	Min Expected Frequency	Max Expected Frequency
-100ppm	$MF - (0.00010452 \times MF)$	$MF - (0.00009548) \times MF$
-66.6ppm	$MF - (0.00007114 \times MF)$	$MF - (0.00006208) \times MF$
+33.3ppm	$MF + (0.00002878 \times MF)$	$MF + (0.00003782) \times MF$
+100ppm	$MF + (0.00009548 \times MF)$	$MF + (0.00010452) \times MF$
+999ppm	$MF + (0.00099448 \times MF)$	$MF + (0.00100352) \times MF$
-999ppm	$MF - (0.00100352 \times MF)$	$MF - (0.00099448) \times MF$

8. Disconnect all the test equipment.

STS-3 Transmitter Output Waveshape (Option 120)

Specifications

Meets ITU Recommendation G.703

Description

An oscilloscope is connected to the HP 37717C Transmitter STS-3 output and used to view the waveforms with All Ones and All Zeros patterns selected in turn. The displayed waveshape is checked against the relevant ITU G.703 mask. The STS-3 Framing is disabled during this test using the **MODULE DEBUG** function of the HP 37717C.

Equipment Required

Oscilloscope	: HP 54503A
ThinkJet Printer	: HP 2225A
75Ω Termination	: HP 15522-80010
T Connector	: HP 1250-0781

Procedure

CMI All Ones Waveshape

1. Connect up the equipment as shown in Figure 3-58 and Recall HP 37717C DEFAULT SETTINGS as shown on 3-2.

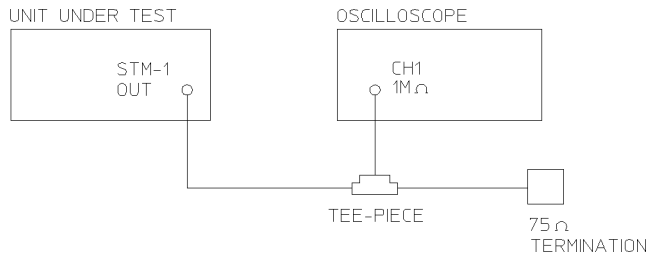

Figure 3-58

STS-3 Transmitter Output Waveshape Test Setup

Performance Tests

STS-3 Transmitter Output Waveshape (Option 120)

2. Press **TRANSMIT** and set up the display as shown opposite.

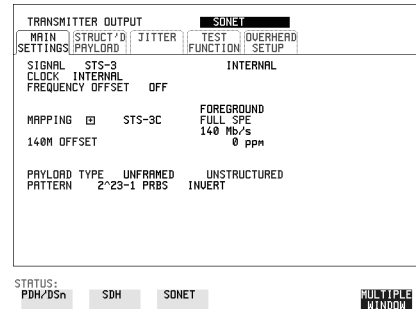

3. Make the following key sequence on the HP 37717C to obtain the special **MODULE DEBUG** display.

Press **OTHER**; **←**; **MORE**; **←**;
MORE; **←**; **MORE**; **OTHER**.

Press **MORE** until **MODULE DEBUG** appears in the softkey menu.

Press **MODULE DEBUG** and set up the display as shown opposite.

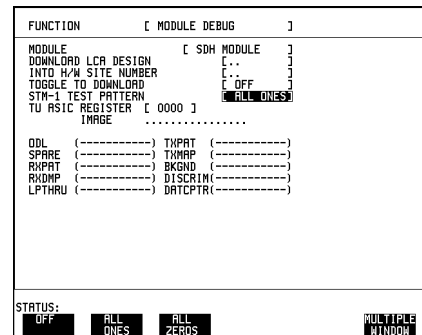

CAUTION

When using the **MODULE DEBUG** display, ONLY modify the STM-1 TEST PATTERN. Altering other parameters can damage instrument firmware - exit this display after setup to eliminate any possibility of accidental modification.

4. Adjust the Oscilloscope controls to display the waveform as shown in Figure 3-59, STS-3 All Ones Pattern.
5. Use the Oscilloscope PRINT function to obtain a printout of the STS-3 waveform on the external printer.
6. Ensure this printout fits the STS-3 Mask of Figure 3-60.

NOTE

If a mylar mask is not available, the figure shown may be traced or photocopied onto a transparency.

Performance Tests

STS-3 Transmitter Output Waveshape (Option 120)

- Adjust the Oscilloscope controls to display the waveform as shown in Figure 3-61, STS-3 All Zeros Pattern Example.
- Use the Oscilloscope PRINT function to obtain a printout of the STS-3 waveform on the external printer.
- Ensure this printout fits the STS-3 Mask of Figure 3-62.

NOTE

If a mylar mask is not available, the figure shown may be traced or photocopied onto a transparency.

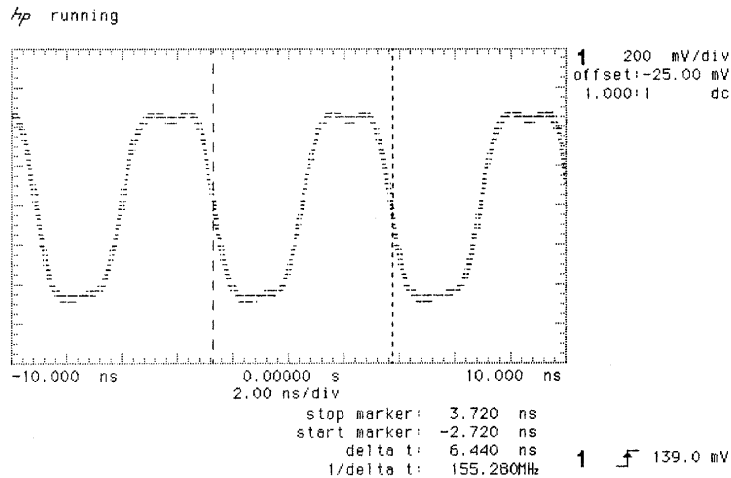
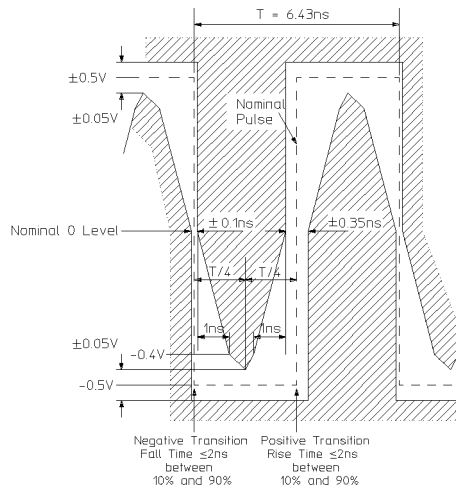

Figure 3-61

STS-3 All Zeros Pattern

Performance Tests

STS-3 Transmitter Output Waveshape (Option 120)



Note 1. The mask does not include the over/undershoot tolerance of 10%.

Note 2. The nominal zero level can be adjusted by $\pm 0.05\text{V}$ to meet the limits of the mask.

Figure 3-62

STS-3 All Zeros Mask

11. Select STS-3 TEST PATTERN [OFF] on the **OTHER** DEBUG FUNCTION display.
12. Select PATTERN [2^23-1] on the **TRANSMIT** display.
13. Adjust the Oscilloscope controls to display the eye diagram as shown in Figure 3-63, STS-3 Eye Diagram Example. Check that the waveform meets the STS-3 eye diagram mask. It may be necessary to adjust the V/div gain on the Oscilloscope.

Performance Tests
STS-3 Transmitter Output Waveshape (Option 120)

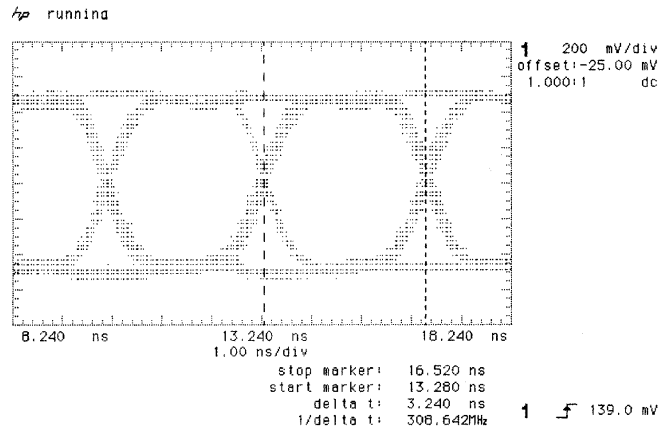

Figure 3-63 STS-3 Eye Diagram Pattern

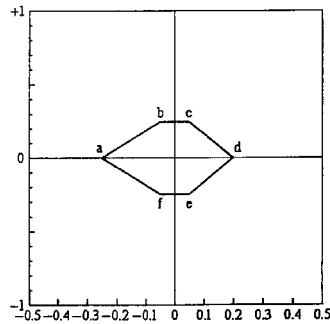

Figure 3-64 STS-3 Eye Diagram Mask

NOTE

If the mask is not available then Figure 3-64 may be traced/copied and compared with the Oscilloscope print out.

Performance Tests

STM-1/STS-3 Receiver Monitor Input (Options A1T, A1U, A3R, [A3S], 120)

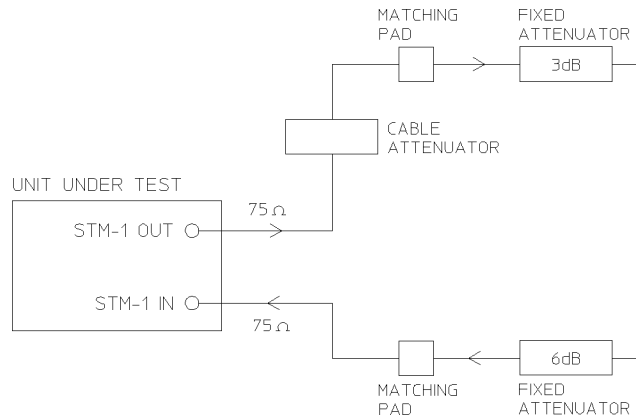

Figure 3-65

STS-3 Receiver Monitor Input

4. Press **SIGNAL IN** until the Monitor led above the key is lit.
5. Press **RECEIVE** and select GAIN [20 dB].
6. Verify that all the front panel ALARM leds are off.
7. Press **RESULTS** **TROUBLE SCAN** and **RUN/STOP**, and check that the display indicates NO TROUBLE.
8. Press **RUN/STOP** to halt the measurement.
9. Connect the second 6 dB Fixed Attenuator between the 3 dB attenuator and the Cable Attenuator.

STM-1/STS-3 Receiver Input Equalization (Options US1, [US5], A1T, [A1U], A3R, [A3S],120)

STM-1/STS-3 Receiver Input Equalization (Options US1, [US5], A1T, [A1U], A3R, [A3S],120)

Specification

Receiver Equalization Automatic for cable loss up to 12dB at half the bit rate.

Description

Receiver Equalization is verified by inserting the special Cable between the STS-3 OUT port and the STS-3 IN port and checking for error-free operation.

Equipment Required

Cable Attenuator (70 m) : HP 8120-0049

Procedure

1. Recall the HP 37717C DEFAULT SETTINGS as shown on 3-2.
2. Select TRANSMITTER OUTPUT [SDH] or [SONET] and RECEIVER INPUT [SDH] or [SONET].
3. Connect the OUT port to the IN port, via the Cable Attenuator.
4. Verify that all the front panel Alarm leds are off.
5. Press **RESULTS** **TROUBLE SCAN** : **RUN/STOP** and check that the display indicates NO TROUBLE.
6. Press **RUN/STOP** to halt the measurement.
7. Disconnect all the test equipment.

ETSI/ANSI Internal Transmitter Clock Rates (Option 110)

Specification

Rate	Frequency	Accuracy	Temperature Stability	Ageing Stability
DS1	1.544Mb/s	+/-0.7ppm @25C	<=3ppm (0 to +50C)	<=1ppm/Year
DS3	44.736Mb/s	+/-0.5ppm @25C	<=3ppm (0 to +50C)	<=1ppm/Year
E1	2.048Mb/s	+/-0.5ppm @25C	<=3ppm (0 to +50C)	<=1ppm/Year
E3	34.368Mb/s	+/-0.5ppm @25C	<=3ppm (0 to +50C)	<=1ppm/Year

Description

A frequency Counter terminated in 75 ohms and connected to the Option 110 Transmit Module front panel Clock Out Port is used to verify the frequency accuracy of the transmitted data at all rates.

E3 (34.368Mb/s) Frequency Accuracy

1. Recall the HP 37717C Default Settings as shown on 3-2. Select TRANSMIT, PDH/DSn, MAIN SETTINGS and set the SIGNAL to 34 Mb/s.
2. Adjust the Frequency Counter ATTEN and Trigger Level to obtain a stable reading and ensure that the frequency counter reading is between 34367845.3 Hz and 34368154.7 Hz.
3. Set the FREQUENCY OFFSET to [USER OFFSET] [+20PPM].
4. Adjust the Frequency Counter ATTEN and Trigger Level to obtain a stable reading and ensure that the frequency counter reading is between 34368532.7 Hz and 34368842.0 Hz.
5. Set the FREQUENCY OFFSET to [USER OFFSET] [-20PPM].
6. Adjust the Frequency Counter ATTEN and Trigger Level to obtain a stable reading and ensure that the frequency counter reading is between 34367158.0 Hz and 34367467.3 Hz.

Performance Tests

ETSI/ANSI Internal Transmitter Clock Rates (Option 110)

E1 (2.048Mb/s) Frequency Accuracy

1. Set the transmitter to Signal [E1 2Mb/s].
2. Adjust the Frequency Counter ATTEN and Trigger Level to obtain a stable reading and ensure that the frequency counter reading is between 2047990.8 Hz and 2048009.2Hz.
3. Set the FREQUENCY OFFSET to [USER OFFSET] [+50PPM].
4. Adjust the Frequency Counter ATTEN and Trigger Level to obtain a stable reading and ensure that the frequency counter reading is between 2048093.2 Hz and 2048111.6 Hz.
5. Set the FREQUENCY OFFSET to [USER OFFSET] [-50PPM].
6. Adjust the Frequency Counter ATTEN and Trigger Level to obtain a stable reading and ensure that the frequency counter reading is between 2047888.4 Hz and 2047906.8 Hz.

DS1 Frequency Accuracy

1. Set the transmitter to Signal [DS1 1.5Mb/s].
2. Adjust the Frequency Counter ATTEN and Trigger Level to obtain a stable reading and ensure that the frequency counter reading is between 1543992.7 Hz and 1544007.3 Hz.
3. Set the FREQUENCY OFFSET to [+32PPM].
4. Adjust the Frequency Counter ATTEN and Trigger Level to obtain a stable reading and ensure that the frequency counter reading is between 1544042.2 Hz and 1544056.7 Hz.
5. Set the FREQUENCY OFFSET to [-32PPM].
6. Adjust the Frequency Counter ATTEN and Trigger Level to obtain a stable reading and ensure that the frequency counter reading is between 1543943.3 Hz and 1543957.8 Hz.

DS3 Frequency Accuracy

1. Set the transmitter to Signal [DS3].
2. Connect the Clock Output port on the HP 37717C Option 110 Transmit Module to the Frequency Counter Channel A. Terminate in 75 ohm.

Performance Tests

ETSI/ANSI Internal Transmitter Clock Rates (Option 110)

3. Adjust the Frequency Counter ATTEN and Trigger Level to obtain a stable reading and ensure that the frequency counter reading is between 44735798.7 Hz and 44736201.3 Hz.
4. Select the HP 37717C TRANSMIT page, and set FREQUENCY OFFSET to [+20PPM].
5. Adjust the Frequency Counter ATTEN and Trigger Level to obtain a stable reading and ensure that the frequency counter reading is between 44736693.4 Hz and 44737096.0 Hz.
6. Set the FREQUENCY OFFSET to [-20PPM].
7. Adjust the Frequency Counter ATTEN and Trigger Level to obtain a stable reading and ensure that the frequency counter reading is between 44734904.0 Hz and 44735306.6 Hz.

ETSI/ANSI Transmitter Output Level and Waveshape (Option 110)

Specification

Rate	Frequency	Level	Waveshape
DSX-1	1.544Mb/s	3.0V +/-20%	Fits mask T1.102-1993
DS1-LO	1.544Mb/s		As DSX-1 with 655' ABAM Cable
DS3-HI	44.736Mb/s	0.9V pk (nominal)	
DSX-3	44.736Mb/s	560mV pk (nominal)	Fits mask T1.102-1993
DS3-900	44.736Mb/s	330mV pk (nominal)	
E1 (bal)	2.048Mb/s	3.00V +/-10%	As per ITU rec G703
E1 (unbal)	2.048Mb/s	2.37V +/-10%	As per ITU rec G703
E3	34.368Mb/s	1.0V +/-10%	As per ITU rec G703

Description

This test ensures the transmitter output level and pulse shape meet the required specifications at E1,E3,DS1 and DS3 rates. The Transmitter output is connected to an oscilloscope and the waveshape compared with the predefined masks stored in the oscilloscope memory. The signal levels are also measured using the oscilloscope.

ETSI/ANSI Transmitter Output Level and Waveshape (Option 110)

34.368 Mb/s Positive Pulse

1. Recall the HP 37717C Default Settings as shown on 3-2.
2. Select the HP 37717C TRANSMIT page, and set as follows;

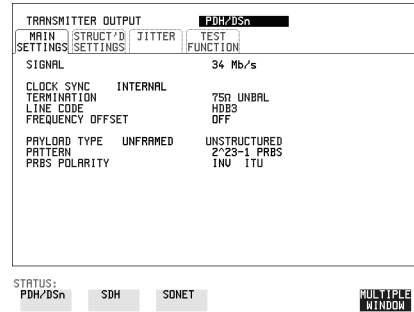

3. Connect the Transmit Module (Option 110) 75 ohms Unbalanced Output to the Oscilloscope via the 75/50 ohm converter.
4. Select CHAN on the oscilloscope and set to 50 ohms input impedance, DC coupled.
5. Select CHANNEL 1 on the oscilloscope and select PROBE 2.45 (attenuation level to compensate for the 75/50 ohm converter).
6. If using the HP 54503A oscilloscope, use the following key sequence to select and store the correct Telecom Mask.
 - a. DEFINE MEAS key.
 - b. COMPARE softkey.
 - c. TEST ON softkey.
 - d. WFORM SAVE key.
 - e. MASK CCITT G703 34Mb softkey.
 - f. STORE to M1 + M2 softkey.
 - g. STORE softkey.
7. Press the SHIFT key on the oscilloscope (colored blue), then MASK AUTO key then 1 key.

The oscilloscope will now automatically display and compare an isolated positive pulse from the HP 37717C with the limits in the selected Telecom Mask. A PASS message should appear on the oscilloscope display when completed.

NOTE

It may be necessary to visibly check the waveform fits the mask and manually adjust amplitude and offset parameters on the oscilloscope to obtain a PASS on the Mask.

8. Measure the peak pulse amplitude at the mid pulse-width using the oscilloscope and verify that this is between 900 mV and 1.100 Volts.

34.368 Mb/s Negative Pulse

1. Select CHAN on the oscilloscope and set OFFSET to -500mV.
2. Select TRIG on the oscilloscope and set to PATTERN H X X X.
3. Select TIMEBASE on the Oscilloscope and set DELAY to 8nS. Adjust the delay manually until the negative pulse is centred on the oscilloscope display.
4. If using the HP 54503A oscilloscope, use the following key sequence to select and store the correct Telecom Mask.
 - a. WFORM SAVE key.
 - b. MASK CCITT G703 34Mb softkey.
 - c. STORE to M1 + M2.
 - e. STORE INVERSE.
5. Compare the isolated negative pulse from the HP 37717C with the limits in the selected Telecom Mask.
6. Ensure the waveform fits the mask.

NOTE

It may be necessary to visibly check the waveform fits the mask and manually adjust amplitude and offset parameters on the oscilloscope to obtain a PASS on the Mask.

7. Measure the peak pulse amplitude at the mid pulse-width using the oscilloscope and verify that this is between 900 mV and 1.100 Volts.

2.048 Mb/s Positive Pulse

1. Recall the HP 37717C Default Settings as shown on 3-2.

Performance Tests

ETSI/ANSI Transmitter Output Level and Waveshape (Option 110)

2. Select the HP 37717C TRANSMIT page, and set as follows;

TRANSMITTER OUTPUT		PDM/DSn
MAIN	STRUCT	JITTER
SETTINGS	SETTINGS	TEST FUNCTION
SIGNAL		
CLOCK SYNC	INTERNAL	2 Mb/s
TERMINATION		75Ω UNBAL
LINE CODE		HDB3
FREQUENCY OFFSET		OFF
PAYLOAD TYPE	UNFRAMED	UNSTRUCTURED
PATTERN		2 ¹⁵ -1 PRBS
PRBS POLARITY		1W 1TU

STATUS:
34 Mb/s 2 Mb/s DS1 DS3 MULTIPLE WINDOW

3. Select the HP 37717C TRANSMIT page, and set as follows:

4. Connect the 110 Transmit Module 75 ohms Unbalanced Output to the Oscilloscope via the 75/50 ohm converter.

5. Select CHAN on the oscilloscope and set to 50 ohms input impedance, DC coupled.

6. Select CHANNEL 1 on the oscilloscope and select PROBE 2.45 (attenuation level to compensate for the 75/50 ohm converter).

7. If using the HP 54503A oscilloscope, use the following key sequence to select and store the correct Telecom Mask.

- DEFINE MEAS key.
- COMPARE softkey.
- TEST ON softkey.
- WFORM SAVE key.
- MASK CCITT G703 DS1E 2.0 Mb softkey.
- STORE to M1 + M2 softkey.
- STORE softkey.

8. Press the SHIFT key on the oscilloscope (colored blue), then MASK AUTO key, then 1 key.

The oscilloscope will now automatically display and compare the isolated positive pulse from the HP 37717C with the limits in the selected Telecom Mask.

NOTE

It may be necessary to visibly check the waveform fits the mask and manually adjust amplitude and offset parameters on the oscilloscope to obtain a PASS on the Mask.

9. Measure the peak pulse amplitude at the mid pulse-width using the oscilloscope and verify that this is between 2.133V and 2.607V.

ETSI/ANSI Transmitter Output Level and Waveshape (Option 110)

2.048 Mb/s Negative Pulse

1. Select CHAN on the oscilloscope and set OFFSET to -800mV.
2. Select TRIG on the oscilloscope and set to PATTERN H X X X.
3. Select TIMEBASE on the Oscilloscope and set DELAY to 126 nS. Adjust the delay manually until the negative pulse is centred on the oscilloscope display.
4. If using the HP 54503A oscilloscope, use the following key sequence to select and store the correct Telecom Mask.
 - a. WFORM SAVE key.
 - b. MASK CCITT G703 DS1E 2.0 Mb softkey.
 - c. STORE to M1 + M2.
 - e. STORE INVERSE.
5. Compare the isolated negative pulse from the HP 37717C with the limits in the selected Telecom Mask.
6. Ensure the waveform fits the mask.

NOTE

It may be necessary to visibly check the waveform fits the mask and manually adjust amplitude and offset parameters on the oscilloscope to obtain a PASS on the Mask.

7. Measure the peak pulse amplitude at the mid pulse-width using the oscilloscope and verify that this is between 2.133V and 2.607V.

DSX-3 Positive Pulse

1. Recall the HP 37717C Default Settings as shown on 3-2.
2. Select the HP 37717C TRANSMIT page, select PHYSICAL LAYER and set as follows;

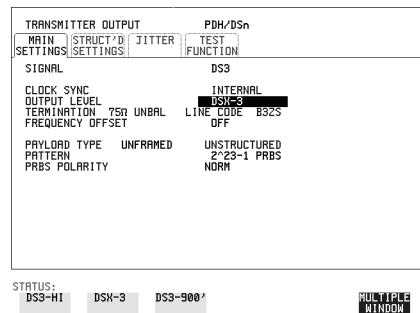

3. Connect the 110 Transmit Module 75 ohms Unbalanced Output to the Oscilloscope via the 75/50 ohm converter.

Performance Tests

ETSI/ANSI Transmitter Output Level and Waveshape (Option 110)

4. Select CHAN on the oscilloscope and set to 50 ohms input impedance, DC coupled.
5. Select CHANNEL 1 on the oscilloscope and select PROBE 2.45 (attenuation level to compensate for the 75/50 ohm converter).
6. If using the HP 54503A oscilloscope, use the following key sequence to select and store the correct Telecom Mask.
 - a. DEFINE MEAS key.
 - b. COMPARE softkey.
 - c. TEST ON softkey.
 - d. WFORM SAVE key.
 - e. MASK DS3 45 Mb ANSI T1.102 softkey.
 - f. STORE to M1 + M2 softkey.
 - g. STORE softkey.
7. Press the SHIFT key on the oscilloscope (colored blue), then MASK AUTO key, then 1 key.

The oscilloscope will now automatically display and compare the isolated positive pulse from the HP 37717C with the limits in the selected Telecom Mask.

NOTE

It may be necessary to visibly check the waveform fits the mask and manually adjust amplitude and offset parameters on the oscilloscope to obtain a PASS on the Mask.

DSX-3 Negative Pulse

1. Select CHAN on the oscilloscope and set OFFSET to -270 mV.
2. Select TRIG on the oscilloscope and set to PATTERN H X X X.
3. Select TIMEBASE on the Oscilloscope and set DELAY to -186 nS. Adjust the delay manually until the negative pulse is centred on the oscilloscope display.
4. If using the HP 54503A oscilloscope, use the following key sequence to select and store the correct Telecom Mask.
 - a. WFORM SAVE key.
 - b. MASK DS3 45 Mb ANSI T1.102 softkey.
 - c. STORE to M1 + M2.
 - e. STORE INVERSE.
5. Compare the isolated negative pulse from the HP 37717C with the limits in the selected Telecom Mask.

Performance Tests

ETSI/ANSI Transmitter Output Level and Waveshape (Option 110)

6. Ensure the waveform fits the mask.

NOTE

It may be necessary to visibly check the waveform fits the mask and manually adjust amplitude and offset parameters on the oscilloscope to obtain a PASS on the Mask.

DSX-1 Positive Pulse

1. Recall the HP 37717C Default Settings as shown on 3-2.
2. Select the HP 37717C TRANSMIT page, and set as follows;

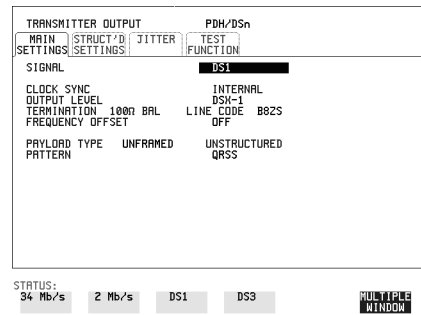

3. Connect the 110 Transmit Module 100 ohm Balanced Output to the Oscilloscope via the HP 15508B Balanced to unbalanced Converter and HP 11852B 75/50 ohm converter.
4. Select CHAN on the oscilloscope and set to 50 ohms input impedance, DC coupled.
5. Select CHANNEL 1 on the oscilloscope and select PROBE 2.45 (attenuation level to compensate for the 75/50 ohm converter).
6. If using the HP 54503A oscilloscope, use the following key sequence to select and store the correct Telecom Mask.
 - a. DEFINE MEAS key.
 - b. COMPARE softkey.
 - c. TEST ON softkey.
 - d. WFORM SAVE key.
 - e. MASK DS1 new 1.5 Mb ANSI T1.102 softkey.
 - f. STORE to M1 + M2 softkey.
 - g. STORE softkey.
7. Press the SHIFT key on the oscilloscope (colored blue), then MASK AUTO key, then 1 key.

Performance Tests

ETSI/ANSI Transmitter Output Level and Waveshape (Option 110)

The oscilloscope will now automatically display and compare the isolated positive pulse from the HP 37717C with the limits in the selected Telecom Mask.

NOTE

It may be necessary to visibly check the waveform fits the mask and manually adjust amplitude and offset parameters on the oscilloscope to obtain a PASS on the Mask.

8. Measure the peak pulse amplitude at the mid pulse-width using the oscilloscope and verify that this is between 1.984V and 2.976V.

DSX-1 Negative Pulse

1. Select CHAN on the oscilloscope and set OFFSET to -390 mV.
2. Select TRIG on the oscilloscope and set to PATTERN H X X X.
3. Select TIMEBASE on the Oscilloscope and set DELAY to 300 nS. Adjust the delay manually until the negative pulse is centred on the oscilloscope display.
4. If using the HP 54503A oscilloscope, use the following key sequence to select and store the correct Telecom Mask.
 - a. WFORM SAVE key.
 - b. MASK DS1 new 1.5 Mb ANSI T1.102 softkey.
 - c. STORE to M1 + M2.
 - e. STORE INVERSE.
5. Compare the isolated negative pulse from the HP 37717C with the limits in the selected Telecom Mask.
6. Ensure the waveform fits the mask.

NOTE

It may be necessary to visibly check the waveform fits the mask and manually adjust amplitude and offset parameters on the oscilloscope to obtain a PASS on the Mask.

7. Measure the peak pulse amplitude at the mid pulse-width using the oscilloscope and verify that this is between 1.984V and 2.976V.

ETSI/ANSI Receiver Equalization (Option 110)

Specifications

Bit Rate	Cable Loss Accommodation
2.048Mb/s	Up to 6dB for root f cable @ half-bit rate
34.368Mb/s	Automatic equalization up to 12dB for root f cable @ half-bit rate
1.544Mb/s (DS1)	Signal range from DS1-LO to DSX-1
44.736Mb/s (DS3)	Automatic equalization for up to 900 feet of type 728A Cable (root f)

Description

The Receiver Equalization is checked by looping the transmitter output to receiver input through a special Cable Simulator. This device is designed to simulate the specified cable loss at the rate under test. A BER measurement is run and a check made for no errors in the results page.

34.368 Mb/s Equalization

1. Recall the HP 37717C Default Settings as shown on 3-2.
2. Select the HP 37717C TRANSMIT page, and set as follows;

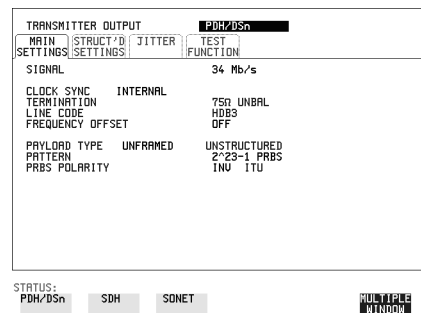

3. Connect Cable Simulator #3 (see Recommended Test Equipment list in Chapter1) between the HP 37717C Transmitter Output and Receiver Input ports.

Performance Tests

ETSI/ANSI Receiver Equalization (Option 110)

4. Press RESULTS [TROUBLE SCAN] , then RUN/STOP key to start the measurement.
5. Ensure that NO TROUBLE is displayed on the RESULTS page after 30 seconds.
6. Press RUN/STOP key to stop the measurement.

2.048Mb/s Equalization

1. Press OTHER key, then SETTINGS CONTROL softkey, then set the TRANSMITTER and RECEIVER to COUPLED.
2. Select the HP 37717C TRANSMIT page, and set as follows;

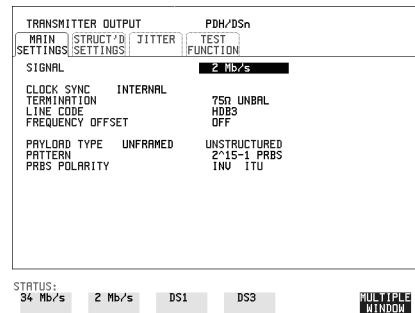

3. Connect Cable Simulator #1 (see “Recommended Test Equipment” in Chapter 1 on Page 67) between the HP 37717C Transmitter Output and Receiver Input ports.
4. Press RESULTS [TROUBLE SCAN] , then RUN/STOP key to start the measurement.
5. Ensure that NO TROUBLE is displayed on the RESULTS page after 30 seconds.
6. Press RUN/STOP key to stop the measurement.

Performance Tests
ETSI/ANSI Receiver Equalization (Option 110)

DS3 Equalization

1. Recall the HP 37717C Default Settings as shown on 3-2.
2. Select the HP 37717C TRANSMIT page, and set as follows;

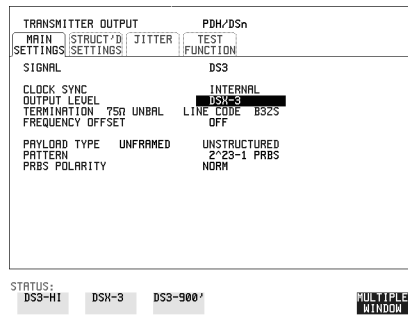

3. Connect Cable Simulator #6 (see “Recommended Test Equipment” in Chapter 1 on Page 67) between the HP 37717C 110 Unbalanced Transmitter Output and Receiver Input ports.

NOTE

If Cable Simulator #6 is not available, it is permissible to select DS3-900' on the Transmitter Page and connect the HP 37717C 110 Unbalanced Transmitter Output port direct to the Receiver Input port. This setup assumes the DS3-900' output signal is within specification.

4. Press RESULTS [TROUBLE SCAN] , then RUN/STOP key to start the measurement.
5. Ensure that NO TROUBLE is displayed on the RESULTS page after 30 seconds.
6. Press RUN/STOP key to stop the measurement.

Performance Tests

ETSI/ANSI Receiver Equalization (Option 110)

DS1 Equalization

1. Recall the HP 37717C Default Settings as shown on 3-2.
2. Select the HP 37717C TRANSMIT page, and set as follows;

TRANSMITTER OUTPUT			PDH/DSn	
MAIN SETTINGS	STRUCT'D SETTINGS	JITTER	TEST FUNCTION	
SIGNAL			DS1	
CLOCK SYNC	INTERNAL			
OUTPUT LEVEL	DSX-1			
TERMINATION	100Ω BAL	LINE CODE	B8ZS	
FREQUENCY OFFSET	OFF			
PAYLOAD TYPE	UNFRAMED	UNSTRUCTURED		
PATTERN	QRSS			

STATUS:
34 Mb/s 2 Mb/s DS1 DS3 MULTIPLE WINDOW

3. Connect Cable Simulator #5 (see “Recommended Test Equipment” in Chapter 1 on Page 67) between the HP 37717C Transmitter Balanced Output and Receiver Balanced Input ports via two Balanced to Unbalanced Converters (HP 15508B).

NOTE

If Cable Simulator #5 is not available, it is permissible to select DS1-LO on the Transmitter Page and connect the HP 37717C 110 Unbalanced Transmitter Output port direct to the Receiver Input port. This setup assumes the DS1-LO output signal is within specification.

4. Press RESULTS [TROUBLE SCAN] , then RUN/STOP key to start the measurement.
5. Ensure that NO TROUBLE is displayed on the RESULTS page after 30 seconds.
6. Press RUN/STOP key to stop the measurement.

Performance Tests
ETSI/ANSI Receiver Monitor Levels (Option 110)

ETSI/ANSI Receiver Monitor Levels (Option 110)

NOTE

An SPDH Tx Module must be fitted for this test - see Appendix B.

Specifications

Bit Rate	Nominal Loss	Equalization at 1/2 Bit Rate
2.048 Mb/s	20, 26, 30dB	3dB
1.544 Mb/s (DS-1)	20, 26, 30dB	3dB
34.368 Mb/s	20, 26dB	6dB
44.736 Mb/s (DS-3)	20, 26dB	6dB

Description

The signal from the HP 37717C Option 110 PDH Transmitter is applied to the Option 110 PDH Receiver after attenuating by an amount equal to the selected Receiver Flat Loss plus the specified Cable Loss. The Flat Loss is obtained by inserting a number of 50Ω fixed attenuators in series with a $75/50\Omega$ Matching Pad at one end and a $50/75\Omega$ Matching Pad at the other end. The loss of the two Matching Pads is included in the overall attenuation equation. The Cable Loss is supplied by inserting the correct Cable Simulators for each bit rate in the attenuation path.

Equipment Required

Table3- 10

2M Bit Rate	Cable Simulator #1	
34M Bit Rate	Cable Simulator #3	
1.5M Bit Rate	Cable Simulator #5	
44M Bit Rate	Cable Simulator #6	

Performance Tests
ETSI/ANSI Receiver Monitor Levels (Option 110)

Table3- 10

	Fixed Attenuator (Qty 2)	: HP 8491A Option 006 (6dB; 50Ω)
	Fixed Attenuator (Qty 2)	: HP 8491A Option 003 (3dB; 50Ω)
	Matching Pad 75/50Ω (7.6dB loss)	: HP 11852B
	Matching Pad 50/75Ω (4.2dB loss)	: HP 11852B

Procedure

1. Recall the HP 37717C DEFAULT SETTINGS as shown on 3-2.
2. Connect the equipment as shown in Figure 3-66.

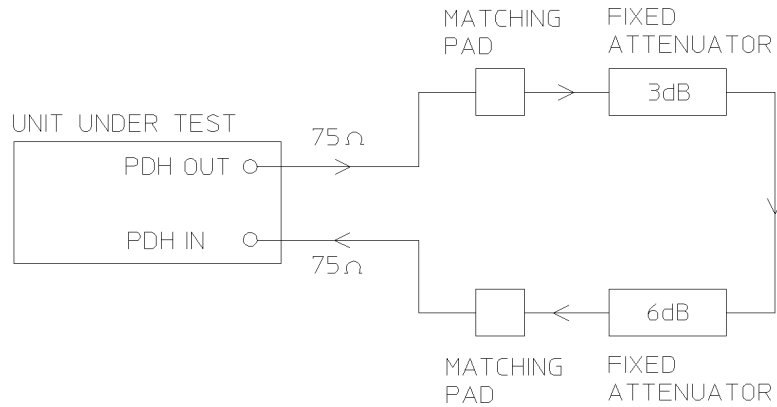

Figure 3-66

Option 110 Receiver Monitor Input

Performance Tests

ETSI/ANSI Receiver Monitor Levels (Option 110)

2.048 Mb/s

3. Press **TRANSMIT** and set up the **MAIN SETTINGS** display as shown opposite.

TRANSMITTER OUTPUT	[PDH]
MAIN STRUCT'D TEST	
SETTINGS SETTINGS FUNCTION	
SIGNAL	[2 Mb/s]
CLOCK SYNC	INTERNAL
TERMINATION	[75Ω UNBAL]
LINE CODE	[HDB3]
FREQUENCY OFFSET	[OFF]
PAYLOAD TYPE	[UNFRAMED]
PATTERN	[2 ⁿ 15-1 PRBS]
PRBS POLARITY	[INV] ITU
STATUS:	
	MULTIPLE WINDOW

4. Press **RECEIVE** and set up the **MAIN SETTINGS** display as shown opposite.

5. Press **RESULTS TROUBLE SCAN**.

Press **RUN/STOP** to start the measurement.

6. Ensure that NO TROUBLE is displayed on the **RESULTS** display

7. After 30 seconds. Press **RUN/STOP** to stop the measurement.

RECEIVER INPUT	[PDH]
MAIN STRUCT'D	
SETTINGS SETTINGS	
SIGNAL	[2 Mb/s]
TERMINATION	[75Ω UNBAL]
LINE CODE	[HDB3]
LEVEL	[MONITOR]
EQUALIZER [ON] GAIN	[20 dB]
PAYLOAD TYPE	[UNFRAMED]
PATTERN	[2 ⁿ 15-1 PRBS]
PRBS POLARITY	[INV] ITU
STATUS:	
2 ⁿ 9-1 PRBS	2 ⁿ 11-1 PRBS
2 ⁿ 15-1 PRBS	2 ⁿ 20-1 PRBS
MORE	MULTIPLE WINDOW

8. Press **RECEIVE** and select EQUALIZATION [ON] GAIN [20 dB].

9. Connect Cable Simulator #1 between the PDH OUT Port and the Matching Pad.

10. Press **RESULTS TROUBLE SCAN**. Press **RUN/STOP** to start the measurement.

11. Ensure that NO TROUBLE is displayed on the **RESULTS** display after 30 seconds. Press **RUN/STOP** to stop the measurement.

12. Connect the second 6dB Fixed Attenuator in the signal path to give a total path attenuation of 26.8dB (7.6+3+6+6+4.2).

13. Press **RECEIVE** and set MONITOR LEVEL [26dB].

14. Press **RESULTS TROUBLE SCAN**. Press **RUN/STOP** to start the measurement.

15. Ensure that NO TROUBLE is displayed on the **RESULTS** display after 30 seconds. Press **RUN/STOP** to stop the measurement.

Performance Tests

ETSI/ANSI Receiver Monitor Levels (Option 110)

16. Remove Cable Simulator #1 from the signal path.
17. Press **RECEIVE** and select EQUALIZATION [OFF].
18. Press **RESULTS**; **TROUBLE SCAN** . Press **RUN/STOP** to start the measurement.
19. Ensure that NO TROUBLE is displayed on the **RESULTS** display after 30 seconds. Press **RUN/STOP** to stop the measurement.
20. Connect the second 3dB Fixed Attenuator in the signal path to give a total path attenuation of 29.8dB (7.6+3+3+6+6+4.2).
21. Press **RECEIVE** and set MONITOR LEVEL [30dB].
22. Press **RESULTS** **TROUBLE SCAN** . Press **RUN/STOP** to start the measurement.
23. Ensure that NO TROUBLE is displayed on the **RESULTS** display after 30 seconds. Press **RUN/STOP** to stop the measurement.
24. Press **RECEIVE** and select EQUALIZATION [ON].
25. Connect Cable Simulator #1 between the PDH OUT Port and the Matching Pad.
26. Press **RESULTS** **TROUBLE SCAN** . Press **RUN/STOP** to start the measurement.
27. Ensure that NO TROUBLE is displayed on the **RESULTS** display after 30 seconds. Press **RUN/STOP** to stop the measurement.

1.544 Mb/s (DS-1)

28. Repeat steps 1 to 26 (20dB, 26dB and 30dB tests) with the HP 37717C **TRANSMIT** and **RECEIVE** displays set to SIGNAL [DSX-1] and Cable Simulator #5 fitted in place of Cable Simulator #1.

34.368 Mb/s

29. Repeat steps 1 to 18 (20dB and 26dB tests) with the HP 37717C **TRANSMIT** and **RECEIVE** displays set to SIGNAL [34 Mb/s] and Cable Simulator #2 fitted in place of Cable Simulator #5.

44.736 Mb/s (DS-3)

30. Repeat steps 1 to 18 (20dB and 26dB tests) with the HP 37717C **TRANSMIT** and **RECEIVE** displays set to SIGNAL [DSX-3] and Cable Simulator #6 fitted in place of Cable Simulator #2.
31. Disconnect all test equipment.

Performance Tests
Performance Test Record

Performance Test Record

<i>Hewlett-Packard Model 37717C Communications Performance Analyzer</i>	
<i>Location:</i>	<i>Serial No.:</i>
	<i>Tested by:</i>
<i>Temperature:</i>	<i>Certified by:</i>
<i>Humidity:</i>	<i>Date:</i>

Table 11 Performance Test Record

Page No.	Test Description		Result		
			Min	Actual	Max
	<i>Self Test</i>				
3-3	Step 3	All Tests		Pass/Fail	
	<i>PDH Internal Transmitter Clocks</i>				
3-7	Step 5:	704 kb/s (UKK only)	351.99753 kHz		352.00246 kHz
	Step 6:	2 Mb/s	1.0239928 MHz		1.0240072 MHz
	Step 7:	8 Mb/s	4.2239704 MHz		4.2240296 MHz
	Step 8:	34 Mb/s	17.1838797 MHz		17.1841203 MHz
	Step 9:	140 Mb/s	69.6315126 MHz		69.6324874 MHz
	<i>Frequency Offset Bit Rates</i>				
		140 Mb/s			
3-8	Step 11:	+ 15 ppm	69.63255705 MHz		69.63353191 MHz
	Step 12:	- 15 ppm	69.63064218 MHz		69.63126886 MHz
	Step 13:	+ 100 ppm	69.63864986 MHz		69.63927654 MHz
	Step 14:	- 100 ppm	69.62472346 MHz		69.625535014 MHz

Performance Tests
Performance Test Record

Table 11 **Performance Test Record**

Page No.	Test Description		Result		
			Min	Actual	Max
	<i>Frequency Offset</i>				
		34 Mb/s			
3-12	Step 16:	+ 20 ppm	17.1842234 MHz		17.1844640 MHz
		- 20 ppm	17.1835360 MHz		17.1837766 MHz
		8 Mb/s			
		+ 30 ppm	4.2240972 MHz		4.2241563 MHz
		- 30 ppm	4.2238437 MHz		4.2239028 MHz
		2 Mb/s			
		+ 50 ppm	1.0240440 MHz		1.0240584 MHz
		- 50 ppm	1.0239416 MHz		1.0239560 MHz
		704 kb/s (UKK only)			
		+ 50 ppm	352.0151 kHz		352.0201 kHz
		- 50 ppm	351.9799 kHz		351.9849 kHz
	<i>PDH Transmitter Output</i>				
		Unbal 704 kb/s (UKK only)			
3-11	Step 6:	+ve Pulse Amp	2.133 V pk		2.607 V pk
		+ve Pulse Width	639 ns		781 ns
		Overshoot			0.474 V
		Undershoot			0.474 V
3-11	Step 7:	-ve Pulse Amp	2.133 V pk		2.607 V pk
		-ve Pulse Width	639 ns		781 ns
3-11	Step 7:	Overshoot			0.474 V
		Undershoot			0.474 V
		Bal 704 kb/s (UKK only)			
3-12	Step 10:	+ve Pulse Amp	2.133 V pk		2.607 V pk

Performance Tests
Performance Test Record

Table 11 **Performance Test Record**

Page No.	Test Description		Result		
			Min	Actual	Max
		+ve pulse Width	639 ns		781 ns
		Overshoot			0.474 V
		Undershoot			0.474 V
		-ve Pulse Amp	2.133 V pk		2.607 V pk
		-ve Pulse Width	639 ns		781 ns
		Overshoot			0.474 V
		Undershoot			0.474 V
		Unbal 2 Mb/s			
	Step 14:	+ve Pulse Amp	2.133 V pk		2.607 V pk
	Step 16:	+ve Pulse Mask		Pass/Fail	
3-13	Step 20:	-ve Pulse Mask		Pass/Fail	
	Step 21:	-ve Pulse Amp	2.133 V pk		2.607 V pk
3-14	Step 22:	Pulse Amplitude Ratio	0.95		1.05
	Step 23:	Pulse Width Ratio	0.95		1.05
		Bal 2 Mb/s			
3-14	Step 26:	+ve Pulse Amp	2.133 V pk		2.607 V pk
		+ve Pulse Mask		Pass/Fail	
		-ve Pulse Amp	2.133 V pk		2.607 V pk
	Step 26:	-ve Pulse Mask		Pass/Fail	
		Pulse Amplitude Ratio	0.95		1.05
		Pulse Width Ratio	0.95		1.05
		Unbal 8 Mb/s			
	Step 30:	+ve Pulse Amp	2.133 V pk		2.607 V pk
		+ve Pulse Mask		Pass/Fail	
		-ve Pulse Amp	2.133 V pk		2.607 V pk
		-ve Pulse Mask		Pass/Fail	

Performance Tests
Performance Test Record

Table 11 **Performance Test Record**

Page No.	Test Description		Result		
			Min	Actual	Max
		Pulse Amplitude Ratio	0.95		1.05
		Pulse Width Ratio	0.95		1.05
		Unbal 34 Mb/s	<i>Min</i>	<i>Actual</i>	<i>Max</i>
3-17	Step 34:	+ve Pulse Amp	0.900 V pk		1.100 V pk
		+ve Pulse Mask		Pass/Fail	
		-ve Pulse Amp	0.900 V pk		1.100 V pk
		-ve Pulse Mask	Pass/Fail		
		Pulse Amplitude Ratio	0.95		1.05
		Pulse Width Ratio	0.95		1.05
		Unbal 140 Mb/s (All Ones)			
3-19	Step 39:	+ve Pulse Amp	0.900 V pk		1.100 V pk
	Step 40:	+ve Pulse Mask		Pass/Fail	
		Unbal 140 Mb/s (All Zeros)			
3-20	Step 44:	-ve Pulse Amp	0.900 V pk		1.100 V pk
	Step 45:	-ve Pulse Mask		Pass/Fail	
	<i>PDH Multiple TX Outputs</i>				
		704 kb/s Out 2 (UKK only)			
3-24	Step 6:	+ve Pulse Amp	2.133 V pk		2.607 V pk
		+ve Pulse Width	639 ns		781 ns
		Overshoot			0.474 V
		Undershoot			0.474 V
		704 kb/s Out 3 (UKK only)			
	Step 7:	+ve Pulse Amp	2.133 V pk		2.607 V pk

Performance Tests
Performance Test Record

Table 11 **Performance Test Record**

Page No.	Test Description		Result		
			Min	Actual	Max
		+ve Pulse Width	639 ns		781 ns
		Overshoot			0.474 V
		Undershoot			0.474 V
		704 kb/s Out 4 (UKK only)			
		+ve Pulse Amp	2.133 V pk		2.607 V pk
		+ve Pulse Width	639 ns		781 ns
		Overshoot			0.474 V
		Undershoot			0.474 V
	Step 8:	-ve Pulse Amp	2.133 V pk		2.607 V pk
		-ve Pulse Width	639 ns		781 ns
	Step 8:	Overshoot			0.474 V
		Undershoot			0.474 V
		704 kb/s Out 3 (UKK only)			
	Step 9:	-ve Pulse Amp	2.133 V pk		2.607 V pk
		-ve Pulse Width	639 ns		781 ns
		Overshoot			0.474 V
		Undershoot			0.474 V
		704 kb/s Out 2 (UKK only)			
		-ve Pulse Amp	2.133 V pk		2.607 V pk
		-ve Pulse Width	639 ns		781 ns
		Overshoot			0.474 V
		Undershoot			0.474 V
	Step 12:	Delay 1 to 2		4 bits	
3-25	Step 14:	Delay 1 to 3		8 bits	

Performance Tests
Performance Test Record

Table 11 **Performance Test Record**

Page No.	Test Description		Result		
			Min	Actual	Max
	Step 16:	Delay 1 to 4		12 bits	
		2 Mb/s Out 2			
	Step 21:	+ve Pulse Amp	2.133 V pk		2.607 V pk
	Step 23:	+ve Pulse Mask		Pass/Fail	
		2 Mb/s Out 3			
3-26	Step 24:	+ve Pulse Amp	2.133 V pk		2.607 V pk
		+ve Pulse Mask		Pass/Fail	
		2 Mb/s Out 4			
	Step 24:	+ve Pulse Amp	2.133 V pk		2.607 V pk
		+ve Pulse Mask		Pass/Fail	
	Step 27:	-ve Pulse Mask		Pass/Fail	
	Step 28:	-ve Pulse Amp	2.133 V pk		2.607 V pk
		2 Mb/s Out 3			
	Step 29:	-ve Pulse Mask		Pass/Fail	
		-ve Pulse Amp	2.133 V pk		2.607 V pk
		2 Mb/s Out 2			
		-ve Pulse Mask		Pass/Fail	
		-ve Pulse Amp	2.133 V pk		2.607 V pk
3-27	Step 32:	Delay 1 to 2		4 bits	
	Step 34:	Delay 1 to 3		8 bits	
	Step 36:	Delay 1 to 4		12 bits	
	Step 37:	Pulse Amplitude Ratio	0.95		1.05
	Step 38:	Pulse Width Ratio	0.95		1.05
		8 Mb/s Out 2			
	Step 43:	+ve Pulse Amp	2.133 V pk		2.607 V pk

Performance Tests
Performance Test Record

Table 11 **Performance Test Record**

Page No.	Test Description		Result		
			Min	Actual	Max
	Step 45:	+ve Pulse Mask		Pass/Fail	
		8 Mb/s Out 3			
3-28	Step 46:	+ve Pulse Amp	2.133 V pk		2.607 V pk
		+ve Pulse Mask		Pass/Fail	
		8 Mb/s Out 4			
	Step 46:	+ve Pulse Amp	2.133 V pk		2.607 V pk
		+ve Pulse Mask		Pass/Fail	
	Step 49:	-ve Pulse Mask		Pass/Fail	
	Step 50:	-ve Pulse Amp	2.133 V pk		2.607 V pk
		8 Mb/s Out 3			
3-29	Step 51:	-ve Pulse Mask		Pass/Fail	
		-ve Pulse Amp	2.133 V pk		2.607 V pk
		8 Mb/s Out 2			
		-ve Pulse Mask		Pass/Fail	
		-ve Pulse Amp	2.133 V pk		2.607 V pk
	Step 54:	Delay 1 to 2		4 bits	
	Step 56:	Delay 1 to 3		8 bits	
	Step 58:	Delay 1 to 4		12 bits	
	Step 59:	Pulse Amplitude Ratio	0.95		1.05
	Step 60:	Pulse Width Ratio	0.95		1.05
		34 Mb/s Out 2			
	Step 65:	+ve Pulse Amp	0.900 V pk		1.100 V pk
3-30	Step 67:	+ve Pulse Mask		Pass/Fail	
		34 Mb/s Out 3			
	Step 68:	+ve Pulse Amp	0.900 V pk		1.100 V pk
		+ve Pulse Mask		Pass/Fail	

Performance Tests
Performance Test Record

Table 11 **Performance Test Record**

Page No.	Test Description		Result		
			Min	Actual	Max
		34 Mb/s Out 4			
3-30	Step 68:	+ve Pulse Amp	0.900 V pk		1.100 V pk
		+ve Pulse Mask		Pass/Fail	
3-31	Step 71:	-ve Pulse Mask		Pass/Fail	
	Step 72:	-ve Pulse Amp	0.900 V pk		1.100 V pk
		34 Mb/s Out 3			
	Step 73:	-ve Pulse Mask		Pass/Fail	
		-ve Pulse Amp	0.900 V pk		1.100 V pk
		34 Mb/s Out 2			
		-ve Pulse Mask		Pass/Fail	
		-ve Pulse Amp	0.900 V pk		1.100 V pk
	Step 76:	Delay 1 to 2		4 bits	
	Step 78:	Delay 1 to 3		8 bits	
	Step 80:	Delay 1 to 4		12 bits	
	Step 81:	Pulse Amplitude Ratio	0.95		1.05
	Step 82:	Pulse Width Ratio	0.95		1.05
		140 Mb/s Out 2			
3-32	Step 88:	Pulse Amp	0.900 V pk		1.100 V pk
	Step 89:	All 1's Pulse Mask		Pass/Fail	
		140 Mb/s Out 3			
	Step 90:	Pulse Amp	0.900 V pk		1.100 V pk
		All 1's Pulse Mask		Pass/Fail	
		140 Mb/s Out 4			
	Step 90:	Pulse Amp	0.900 V pk		1.100 V pk
		All 1's Pulse Mask		Pass/Fail	
3-33	Step 94:	Pulse Amp	0.900 V pk		1.100 V pk

Performance Tests
Performance Test Record

Table 11 **Performance Test Record**

Page No.	Test Description		Result		
			Min	Actual	Max
	Step 95:	All 0's Pulse Mask		Pass/Fail	
		140 Mb/s Out 3			
	Step 96:	Pulse Amp	0.900 V pk		1.100 V pk
		All 0's Pulse Mask		Pass/Fail	
		140 Mb/s Out 2			
	Step 96:	Pulse Amp	0.900 V pk		1.100 V pk
		All 0's Pulse Mask		Pass/Fail	
3-34	Step 99:	Delay 1 to 2		0 bits	
	Step 101:	Delay 1 to 3		0 bits	
	Step 103:	Delay 1 to 4		0 bits	
	<i>PDH Frame Analysis</i>				
		2 Mb/s			
3-37	Step 4:	Alarms Off		Pass/Fail	
3-37	Step 6:	Multiframe Loss		Pass/Fail	
3-38	Step 7:	Alarms Off		Pass/Fail	
	Step 13:	CRC Errors		Pass/Fail	
	Step 14:	Alarms On		Pass/Fail	
	Step 15:	Alarms Off		Pass/Fail	
	Step 17:	Error Count		Pass/Fail	
	Step 18:	Remote Alarm		Pass/Fail	
	Step 20:	Remote M'frame Alarm		Pass/Fail	
		8 Mb/s			
3-39	Step 3:	Alarms Off		Pass/Fail	
	Step 5:	Remote Alarm		Pass/Fail	
	Step 6:	Frame Errors		Pass/Fail	
	Step 7:	Alarms Off		Pass/Fail	

Performance Tests
Performance Test Record

Table 11 **Performance Test Record**

Page No.	Test Description		Result		
			Min	Actual	Max
	Step 9:	Remote Alarm		Pass/Fail	
	Step 12:	Frame Loss		Pass/Fail	
	Step 13:	Alarms Off		Pass/Fail	
3-40	Step 15:	AIS & Frame Loss		Pass/Fail	
	Step 16:	Alarms Off		Pass/Fail	
		34 Mb/s			
	Step 3:	Alarms Off		Pass/Fail	
	Step 6:	Remote Alarm		Pass/Fail	
	Step 7:	Frame Errors		Pass/Fail	
	Step 8:	Alarms Off		Pass/Fail	
3-41	Step 10:	Remote Alarm		Pass/Fail	
	Step 13:	Frame Loss		Pass/Fail	
	Step 14:	Alarms Off		Pass/Fail	
	Step 16:	AIS & Frame Loss		Pass/Fail	
	Step 17:	Alarms Off		Pass/Fail	
		140 Mb/s			
3-41	Step 4:	Alarms Off		Pass/Fail	
3-42	Step 6:	Remote Alarm		Pass/Fail	
	Step 7:	Frame Errors		Pass/Fail	
	Step 8:	Alarms Off		Pass/Fail	
	Step 10:	Remote Alarm		Pass/Fail	
	Step 13:	Frame Loss		Pass/Fail	
	Step 14:	Alarms Off		Pass/Fail	
	Step 16:	AIS & Frame Loss		Pass/Fail	
	Step 17:	Alarms Off		Pass/Fail	
	<i>PDH Receiver Equalization</i>				

Performance Tests
Performance Test Record

Table 11 **Performance Test Record**

Page No.	Test Description		Result			
			Min	Actual	Max	
3-45	Step 7:	704 kb/s (-6 dB) UKK only		Pass/Fail		
	Step 11:	2 Mb/s (-6 dB)		Pass/Fail		
3-46	Step 14:	8 Mb/s (-6 dB)		Pass/Fail		
	Step 17:	34 Mb/s (-6 dB)		Pass/Fail		
	Step 20:	140 Mb/s (-6 dB)		Pass/Fail		
	<i>PDH Receiver Monitor Levels</i> UKK only					
3-48	Step 7:	704 kb/s (-30 dB)		Pass/Fail		
3-49	Step 10:	2 Mb/s (-30 dB)		Pass/Fail		
	Step 13:	8 Mb/s (-30 dB)		Pass/Fail		
	Step 16:	34 Mb/s (-26 dB)		Pass/Fail		
	Step 19:	140 Mb/s (-26 dB)		Pass/Fail		
	<i>SPDH Receiver Monitor Levels</i> UKJ only					
3-52	Step 7:	Trouble Scan		Pass/Fail		
	Step 11:	Trouble Scan		Pass/Fail		
3-53	Step 15:	Trouble Scan		Pass/Fail		
	Step 19:	Trouble Scan		Pass/Fail		
	Step 23:	Trouble Scan		Pass/Fail		
	Step 27:	Trouble Scan		Pass/Fail		
	Step 28:	Trouble Scan (20 dB)		Pass/Fail		
			Trouble Scan (20 dB, Equalized)		Pass/Fail	
			Trouble Scan (26 dB, Equalized)		Pass/Fail	
		Trouble Scan (26 dB)		Pass/Fail		
		Trouble Scan (30 dB)		Pass/Fail		

Performance Tests
Performance Test Record

Table 11 **Performance Test Record**

Page No.	Test Description		Result		
			Min	Actual	Max
		Trouble Scan (30 dB, Equalized)		Pass/Fail	
	Step 29:	Trouble Scan (20 dB)		Pass/Fail	
		Trouble Scan (20 dB, Equalized)		Pass/Fail	
		Trouble Scan (26 dB, Equalized)		Pass/Fail	
		Trouble Scan (26 dB)		Pass/Fail	
		Trouble Scan (30 dB)		Pass/Fail	
	Step 29:	Trouble Scan (30 dB, Equalized)		Pass/Fail	
3-54	Step 30:	Trouble Scan (20 dB)		Pass/Fail	
		Trouble Scan (20 dB, Equalized)		Pass/Fail	
		Trouble Scan (26 dB, Equalized)		Pass/Fail	
		Trouble Scan (26 dB)		Pass/Fail	
		Trouble Scan (30 dB)		Pass/Fail	
		Trouble Scan (30 dB, Equalized)		Pass/Fail	
	External 2 Mb/s Mux/Demux UKJ only				
3-58	Step 10:	Bit & Code EC		Pass/Fail	
	Step 11:	Bit Error Add		Pass/Fail	
3-59	Step 14:	+ve Pulse Amp	2.133 V pk		2.607 V pk
	Step 16:	+ve Pulse Mask		Pass/Fail	
3-60	Step 20:	-ve Pulse Mask		Pass/Fail	
	Step 21:	-ve Pulse Amp	2.133 V pk		2.607 V pk
3-61	Step 22:	Pulse Amplitude Ratio	0.95		1.05

Performance Tests
Performance Test Record

Table 11 **Performance Test Record**

Page No.	Test Description		Result		
			Min	Actual	Max
	Step 23:	Pulse Width Ratio	0.95		1.05
	External 2 Mb/s Demux UKL only				
3-65	Step 9:	Bit & Code EC		Pass/Fail	
	Step 10:	Bit Error Add		Pass/Fail	
	Step 13:	+ve Pulse Amp	2.133 V pk		2.607 V pk
3-66	Step 15:	+ve Pulse Mask		Pass/Fail	
	Step 19:	-ve Pulse Mask		Pass/Fail	
3-67	Step 20:	-ve Pulse Amp	2.133 V pk		2.607 V pk
	Step 21:	Pulse Amplitude Ratio	0.95		1.05
	Step 22:	Pulse Width Ratio	0.95		1.05
	PDH RX Mon Levels (Special Option 808)				
3-69	Step 7:	704 kb/s (-26 dB)		Pass/Fail	
3-70	Step 10:	2 Mb/s (-26 dB)		Pass/Fail	
	Step 13:	8 Mb/s (-26 dB)		Pass/Fail	
	Step 16:	34 Mb/s (-29 dB)		Pass/Fail	
	Step 19:	140 Mb/s (-26 dB)		Pass/Fail	
	PDH Error Output				
3-72	Step 7:	Bit EC		Pass/Fail	
	Step 8:	Bit ER		Pass/Fail	
	Step 10:	Pulse Period		Pass/Fail	
	Step 11:	No Pulses		Pass/Fail	
	Step 12:	Alarms On		Pass/Fail	
	Step 14:	Pulse Period		Pass/Fail	

Performance Tests
Performance Test Record

Table 11 **Performance Test Record**

Page No.	Test Description		Result		
			Min	Actual	Max
	<i>PDH Frequency Measurement and Looped Clock</i>				
3-75	Step 8:	Frequency	2.047986 MHz		2.048014 MHz
	Step 9:	Offset (0 ppm)	-7 ppm		+7 ppm
	Step 10:	Frequency	2.048190 MHz		2.048219 MHz
	Step 11:	Offset (+100 ppm)	+93 ppm		+107 ppm
	Step 12:	Frequency	2.047781 MHz		2.047810 MHz
	Step 13:	Offset (-100 ppm)	-93 ppm		-107 ppm
		Frequency Counter		Pass/Fail	
	Step 14:	704 kb/s (0 ppm) UKK only	-7 ppm		+7 ppm
		704 kb/s (-100 ppm) UKK only	-93 ppm		-107 ppm
		704 kb/s (+100 ppm) UKK only	+93 ppm		+107 ppm
	:	Offset 8 Mb/s (0 ppm)	-7 ppm		+7 ppm
		Offset 8 Mb/s (-100 ppm)	-93 ppm		-107 ppm
		Offset 8 Mb/s (+100 ppm)	+93 ppm		+107 ppm
		Offset 34 Mb/s (0 ppm)	-7 ppm		+7 ppm
		Offset 34 Mb/s (-100 ppm)	-93 ppm		-107 ppm
		Offset 34 Mb/s (+100 ppm)	+93 ppm		+107 ppm
		Offset 140 Mb/s (0 ppm)	-7 ppm		+7 ppm
		Offset 140 Mb/s (-100 ppm)	-93 ppm		-107 ppm

Performance Tests
Performance Test Record

Table 11 **Performance Test Record**

Page No.	Test Description		Result		
			Min	Actual	Max
		Offset 140 Mb/s (+100 ppm)	+93 ppm		+107 ppm
	<i>Internal SDH Transmitter Clock</i>				
3-78	Step 5:	Frequency	77.759650 MHz		77.760350 MHz
	<i>SDH Frequency Offsets</i>				
3-80	Step 7:	-100 ppm		Pass/Fail	
		-66.6 ppm		Pass/Fail	
		+33.3 ppm		Pass/Fail	
		+100 ppm		Pass/Fail	
		+999 ppm		Pass/Fail	
		-999 ppm		Pass/Fail	
	<i>External MTS Clock</i>				
3-83	Step 7:	Trouble Scan		Pass/Fail	
	Step 13:	Trouble Scan		Pass/Fail	
	Step 19:	Trouble Scan		Pass/Fail	
3-84	Step 21:	Clock Loss		Pass/Fail	
	Step 25:	No Clock Loss		Pass/Fail	
	<i>STM-1 Transmitter Output Waveshape</i>				
3-86	Step 6:	ALL ONES Mask		Pass/Fail	
3-88	Step 10:	ALL ZEROS Mask		Pass/Fail	
3-89	Step 13:	Eye Diagram Mask		Pass/Fail	
	<i>STM-1 Receiver Monitor Input</i>				
3-92	Step 5:	Alarms Off		Pass/Fail	
	Step 6:	Trouble Scan		Pass/Fail	
	<i>STM-1 RX Mon I/P (Special Option 808)</i>				

Performance Tests
Performance Test Record

Table 11 **Performance Test Record**

Page No.	Test Description		Result		
			Min	Actual	Max
3-96	Step 5:	Alarms Off		Pass/Fail	
	Step 6:	Trouble Scan		Pass/Fail	
	<i>STM-1 Receiver Input Equalization</i>				
3-97	Step 4:	Alarms Off		Pass/Fail	
	Step 5:	Trouble Scan		Pass/Fail	
	<i>STM-1 Optical Interface Option UH1</i>				
3-100	Step 6:	Laser Active Led On		Pass/Fail	
	Step 7:	Optical Power	-15 dBm		-8 dBm
	Step 9:	Laser Active Led Off		Pass/Fail	
	Step 14:	Laser Active Led Off		Pass/Fail	
	Step 19:	Trouble Scan		Pass/Fail	
	Step 21:	Laser Active Led Off		Pass/Fail	
	<i>STM-1/STM-4 Optical Interface Option UH2</i>				
3-103	Step 6:	Laser Active Led On		Pass/Fail	
	Step 7:	Optical Power STM-1	-15 dBm		-8 dBm
	Step 9:	Optical Power STM-4	-15 dBm		-8 dBm
	Step 11:	Laser Active Led Off		Pass/Fail	
	Step 16:	Laser Active Led Off		Pass/Fail	
	Step 21:	Trouble Scan		Pass/Fail	
	Step 23:	Laser Active Led Off		Pass/Fail	
	Step 24:	Laser Active Led Off		Pass/Fail	
		Trouble Scan		Pass/Fail	
		Laser Active Led Off		Pass/Fail	

Performance Tests
Performance Test Record

Table 11 **Performance Test Record**

Page No.	Test Description		Result		
			Min	Actual	Max
	<i>STM-1/STM-4 Optical Interface Option URU</i>				
3-106	Step 5:	Laser Active Led On		Pass/Fail	
3-107	Step 13:	Trouble Scan STM-4		Pass/Fail	
	Step 24:	Trouble Scan STM-4		Pass/Fail	
3-108	Step 36:	Trouble Scan STM-4		Pass/Fail	
	Step 39:	Laser Active Led On		Pass/Fail	
		Laser Active Led On		Pass/Fail	
		Trouble Scan STM-1		Pass/Fail	
		Trouble Scan STM-1		Pass/Fail	
		Trouble Scan STM-1		Pass/Fail	
	<i>STM-1/STM-4 Optical Interface Option UKT/USN</i>				
3-111	Step 6:	Laser Active Led ON		Pass/Fail	
	Step 7:	Optical Power STM-1	-15 dBm		-8 dBm
	Step 10:	Optical Power STM-4	-15 dBm		-8 dBm
	Step 11:	Laser Active Led Off		Pass/Fail	
3-112	Step 21:	Trouble Scan STM-1		Pass/Fail	
	Step 22:	Trouble Scan STM-4		Pass/Fail	
3-113	Step 33:	Trouble Scan STM-4 Monitor		Pass/Fail	
	Step 36:	Trouble Scan STM-1 Monitor		Pass/Fail	
3-114	Step 49:	Trouble Scan		Pass/Fail	
3-115	Step 60:	Trouble Scan STM-4		Pass/Fail	
	Step 61:	Trouble Scan STM-1		Pass/Fail	
3-116	Step 73:	Trouble Scan STM-4 Monitor		Pass/Fail	

Performance Tests
Performance Test Record

Table 11 **Performance Test Record**

Page No.	Test Description		Result		
			Min	Actual	Max
	Step 76:	Trouble Scan STM-1 Monitor		Pass/Fail	
	<i>STM-1/STM-4 Optical Interface Option 130/131</i>				
3-119	Step 6:	Laser Active Led ON		Pass/Fail	
	Step 7:	Optical Power STM-1	-15 dBm		-8 dBm
	Step 9:	Optical Power STM-4	-15 dBm		-8 dBm
	Step 11:	Optical Power STM-0	-15 dBm		-8 dBm
	Step 13:	Laser Active Led Off		Pass/Fail	
3-120	Step 23:	Trouble Scan STM-0		Pass/Fail	
	Step 24:	Trouble Scan STM-4		Pass/Fail	
	Step 25:	Trouble Scan STM-4		Pass/Fail	
3-121	Step 36:	Trouble Scan STM-4 Monitor		Pass/Fail	
	Step 39:	Trouble Scan STM-1 Monitor		Pass/Fail	
	Step 40:	Trouble Scan STM-0 Monitor		Pass/Fail	
3-122	Step 53:	Trouble Scan		Pass/Fail	
3-123	Step 64:	Trouble Scan STM-4		Pass/Fail	
	Step 65:	Trouble Scan STM-1		Pass/Fail	
	Step 66:	Trouble Scan STM-0		Pass/Fail	
3-124	Step 78:	Trouble Scan STM-4 Monitor		Pass/Fail	
	Step 81:	Trouble Scan STM-1 Monitor		Pass/Fail	
	Step 82:	Trouble Scan STM-0 Monitor		Pass/Fail	

Performance Tests
Performance Test Record

Table 11 Performance Test Record

Page No.	Test Description		Result		
			Min	Actual	Max
3-138	Step 7:	2048 kHz	0.69 UI		0.83 UI
		8448 kHz	0.69 UI		0.83 UI
		34368 kHz	0.69 UI		0.83 UI
		139264 kHz	0.68 UI		0.84 UI
		2 Mb/s Range 10			
3-140	Step 13:	1.8 UI	1.5 UI		2.0 UI
		4.8 UI	4.4 UI		5.1 UI
		8.8 UI	8.2 UI		9.3 UI
		8 Mb/s, Range 10			
		1.8 UI	1.5 UI		2.0 UI
		5.8 UI	5.3 UI		6.2 UI
		8.8 UI	8.2 UI		9.3 UI
3-140	Step 13:	34 Mb/s, Range 10			
		2.8 UI	2.5 UI		3.0 UI
		6.8 UI	6.2 UI		7.3 UI
		8.8 UI	8.2 UI		9.3 UI
		140 Mb/s, Range 10			
		3.8 UI	3.3 UI		4.2 UI
		7.8 UI	7.1 UI		8.4 UI
		8.8 UI	8.1 UI		9.4 UI
3-142	Step 6:	SDH Range 1	0.69 UI		0.81 UI
	Step 8:	SDH Range 10	1.7 UI		1.8 UI
3-146	Step 6:	SDH Range 50	58.09kHz		65.99 kHz
3-144	Step 5:	PDH Range 80I	5.76 kHz		6.72 kHz
3-146	Step 7:	External Jitter	1.76 V pk_pkI		2.84 V pk_pk
3-148	Step 8:	Wander	74.500 Bits		85.500 Bits

Performance Tests
Performance Test Record

Table 11 **Performance Test Record**

Page No.	Test Description		Result		
			Min	Actual	Max
	<i>RX Jitter Accuracy Option UHN</i>				
3-150	Step 7:	CAL Complete		Pass/Fail	
		Jitter Hit Count			
3-152	Step 13:	Hit Count	211860		216140
		Demodulated Jitter O/P			
	Step 16:	Amplitude	435 mV pk_pk		565 mV pk_pk
	<i>Wander/Slips Accuracy</i>				
3-155	Step 6:	75Ω REF		Pass/Fail	
	Step 10:	120Ω REF		Pass/Fail	
	Step 11:	NO REF		Pass/Fail	
3-157	Step 19:	Bit Slips	-955		-964
		Frame Slips	-3		-4
	Step 20:	+ve Peak		Pass/Fail	
		-ve Peak	955.125		964.875
	Step 20:	Peak-Peak	955.125		964.875
		Time Interval Error	-955.125		-964.875
	Step 24:	Bit Slips	955		964
		Frame Slips	3		4
3-158	Step 25:	+ve Peak	955.125		964.875
		-ve Peak		Pass/Fail	
		Peak-Peak	955.125		964.875
		Time Interval Error	955.125		964.875
	<i>Jitter Receiver STM-IE Input Equalization</i>				
3-159	Step 4:	Alarms Off		Pass/Fail	
	Step 5:	Trouble Scan		Pass/Fail	

Performance Tests
Performance Test Record

Table 11 **Performance Test Record**

Page No.	Test Description		Result		
			Min	Actual	Max
	<i>Jitter Receiver STM-1E Monitor Input</i>				
3-161	Step 5:	Alarms Off		Pass/Fail	
	Step 6:	Trouble Scan		Pass/Fail	
	<i>Jitter Receiver STM-1 Optical Interface</i>				
3-163	Step 2:	Laser Active Led On		Pass/Fail	
3-164	Step 15:	Trouble Scan		Pass/Fail	
	<i>Jitter Receiver STM-1/STM-4 Optical Interface</i>				
3-166	Step 7:	Laser Active Led On		Pass/Fail	
3-167	Step 14:	Trouble Scan		Pass/Fail	
	Step 17:	Trouble Scan		Pass/Fail	
	<i>Binary Interfaces</i>				
3-171	Step 8:	Alarms Off		Pass/Fail	
	Step 11:	Alarms Off		Pass/Fail	
3-172	Step 14:	Alarms Off		Pass/Fail	
	Step 17:	Alarms Off		Pass/Fail	
	Unstructured PDH				
3-173	Step 6:	Mark/Space Ratio		Pass/Fail	
3-174	Step 10:	Mark/Space Ratio		Pass/Fail	
	Structured PDH				
3-175	Step 6:	Mark/Space Ratio		Pass/Fail	
	Step 7:	Mark/Space Ratio		Pass/Fail	
	Step 11:	Mark/Space Ratio		Pass/Fail	
	Step 12:	Mark/Space Ratio		Pass/Fail	

Performance Tests
Performance Test Record

Table 11 **Performance Test Record**

Page No.	Test Description		Result		
			Min	Actual	Max
ETSI/ANSI Internal Transmitter Clock Rates (Option UKZ)					
	<i>DS3 Frequency Accuracy</i>				
3-176	Step 3	Frequency	44735798.6 Hz		44736201.4 Hz
	Step 5	Frequency	44736693.4 Hz		44737096.0 Hz
3-177	Step 7	Frequency	44734904.0 Hz		44735306.6 Hz
	<i>E1 (2.048Mb/s) Frequency Accuracy</i>				
	Step 2	Frequency	2047985.6 Hz		2048014.4Hz
	Step 4	Frequency	2048088 Hz		2048116.8 Hz.
	Step 6	Frequency	2047883.2 Hz		2047912.0 Hz
	<i>E3 (34.368Mb/s) Frequency Accuracy</i>				
	Step 2	Frequency	34367759.4 Hz		34368240.6 Hz
	Step 4	Frequency	34368446.8 Hz		34368928 Hz
	Step 6	Frequency	34367072.0 Hz		34367553.2 Hz
	<i>DS1 Frequency Accuracy</i>				
3-178	Step 2	Frequency	1543993 Hz		1544007 Hz
	Step 4	Frequency	1544042.4 Hz		1544056.4 Hz
	Step 6	Frequency	1543943.6 Hz		1543957.6 Hz
Transmitter Output Level and Waveshape (Option UKZ)					
	<i>34.368 Mb/s Positive Pulse</i>				
3-181	Step 8	Pulse Mask		Pass/Fail	
	Step 9	peak pulse amplitude	900 mV		1.100 Volts
	<i>34.368 Mb/s Negative Pulse</i>				
3-182	Step 7	Pulse Mask		Pass/Fail	
	Step 8	peak pulse amplitude	900 mV		1.100 Volts
	<i>2.048 Mb/s Positive Pulse</i>				

Performance Tests
Performance Test Record

Table 11 **Performance Test Record**

Page No.	Test Description		Result		
			Min	Actual	Max
3-183	Step 8	Pulse Mask		Pass/Fail	
	Step 9	peak pulse amplitude	2.133V		2.607V
	<i>2.048 Mb/s Negative Pulse</i>				
3-184	Step 7	Pulse Mask			
	Step 8	peak pulse amplitude	2.133V		2.607V
	<i>DSX-3 Positive Pulse</i>				
3-186	Step 8	Pulse Mask		Pass/Fail	
	<i>DSX-3 Negative Pulse</i>				
3-187	Step 7	Pulse Mask		Pass/Fail	
	<i>DSX-1 Positive Pulse</i>				
3-188	Step 8	Pulse Mask		Pass/Fail	
	Step 9	peak pulse amplitude	1.984V		2.976V
	<i>DSX-1 Negative Pulse</i>				
3-189	Step 7	Pulse Mask		Pass/Fail	
	Step 8	peak pulse amplitude	1.984V		2.976V
ETSI/ANSI Receiver Equalization (Option UKZ)					
	<i>2.048Mb/s Equalization</i>				
3-191	Step 6	Trouble Scan		Pass/Fail	
	<i>34.368 Mb/s Equalization</i>				
	Step 4	Trouble Scan		Pass/Fail	
	<i>DS3 Equalization</i>				
3-192	Step 5	Trouble Scan		Pass/Fail	
	<i>DS1 Equalization</i>				
3-193	Step 6	Trouble Scan		Pass/Fail	
ETSI/ANSI Receiver Monitor Levels (Option UKZ)					
	<i>2.048Mb/s 20dB Monitor</i>				

Performance Tests
Performance Test Record

Table 11 **Performance Test Record**

Page No.	Test Description		Result		
			Min	Actual	Max
3-195	Step 6	Trouble Scan		Pass/Fail	
	<i>2.048Mb/s 26dB Monitor</i>				
3-196	Step 11	Trouble Scan		Pass/Fail	
	<i>2.048Mb/s 30dB Monitor</i>				
	Step 16	Trouble Scan		Pass/Fail	
	<i>34.368 Mb/s 20dB Monitor</i>				
3-197	Step 6	Trouble Scan		Pass/Fail	
	<i>34.368 Mb/s 26dB Monitor</i>				
	Step 11	Trouble Scan		Pass/Fail	
	<i>DS3 20dB Monitor</i>				
3-198	Step 6	Trouble Scan		Pass/Fail	
	<i>DS3 26dB Monitor</i>				
3-199	Step 11	Trouble Scan		Pass/Fail	
	<i>DS1 20dB Monitor</i>				
	Step 6	Trouble Scan		Pass/Fail	
	<i>DS1 26dB Monitor</i>				
3-200	Step 11	Trouble Scan		Pass/Fail	
	<i>DS1 30dB Monitor</i>				
	Step 16	Trouble Scan		Pass/Fail	
Trigger Output (Option UKZ)					
3-202	Step 8	TTL output Level		Pass/Fail	
	<i>Internal SONET Transmitter Clock (Option 120)</i>				
3-205	Step 5:	Frequency	77.759650 MHz		77.760350 MHz
	<i>SONET Frequency Offsets (Option 120)</i>				
3-207	Step 7:	-100 ppm		Pass/Fail	

Performance Tests
Performance Test Record

Table 11 **Performance Test Record**

Page No.	Test Description		Result		
			Min	Actual	Max
		-66.6 ppm		Pass/Fail	
		+33.3 ppm		Pass/Fail	
		+100 ppm		Pass/Fail	
		+999 ppm		Pass/Fail	
		-999 ppm		Pass/Fail	
	<i>STS-3 Transmitter Output Waveshape (Option 120)</i>				
3-210	Step 6:	ALL ONES Mask		Pass/Fail	
3-212	Step 10	ALL ZEROS Mask		Pass/Fail	
3-213	Step 13:	Eye Diagram Mask		Pass/Fail	
	<i>STM-1/STS-3 Receiver Monitor Input (Option 120)</i>				
3-216	Step 6:	Alarms Off		Pass/Fail	
	Step 7:	Trouble Scan		Pass/Fail	
	<i>STS-3 Receiver Input Equalization (Option 120)</i>				
3-217	Step 4:	Alarms Off		Pass/Fail	
	Step 5:	Trouble Scan		Pass/Fail	
ETSI/ANSI Internal Transmitter Clock Rates (Option 110)					
	<i>DS3 Frequency Accuracy</i>				
3-220	Step 5:	Frequency	44735798.7 Hz		44736201.3 Hz
	Step 6:	Frequency	44736693.4 Hz		44737096.0 Hz
3-220	Step 7	Frequency	44734904.0 Hz		44735306.6 Hz
	<i>EI (2.048Mb/s) Frequency Accuracy</i>				
3-219	Step 2	Frequency	2047990.8 Hz		2048009.2 Hz

Performance Tests
Performance Test Record

Table 11 Performance Test Record

Page No.	Test Description		Result		
			Min	Actual	Max
	Step 4	Frequency	2048093.2 Hz		2048111.6 Hz.
	Step 6	Frequency	2047888.4 Hz		2047906.8 Hz
	<i>E3 (34.368Mb/s) Frequency Accuracy</i>				
3-218	Step 2	Frequency	34367845.3 Hz		34368154.7 Hz
	Step 4	Frequency	34368532.7 Hz		34368842.0 Hz
	Step 6	Frequency	34367158.0 Hz		34367467.3 Hz
3-219	<i>DSI Frequency Accuracy</i>				
	Step 2	Frequency	1543992.7 Hz		1544007.3 Hz
	Step 4	Frequency	1544042.2 Hz		1544056.7 Hz
	Step 6	Frequency	1543943.3 Hz		1543957.8 Hz
Transmitter Output Level and Waveshape (Option 110)					
	<i>34.368 Mb/s Positive Pulse</i>				
3-222	Step 7	Pulse Mask		Pass/Fail	
3-223	Step 8	peak pulse amplitude	900 mV		1.100 Volts
	<i>34.368 Mb/s Negative Pulse</i>				
	Step 6	Pulse Mask		Pass/Fail	
	Step 7	peak pulse amplitude	900 mV		1.100 Volts
	<i>2.048 Mb/s Positive Pulse</i>				
3-224	Step 8	Pulse Mask		Pass/Fail	
	Step 9	peak pulse amplitude	2.133V		2.607V
	<i>2.048 Mb/s Negative Pulse</i>				
3-225	Step 6	Pulse Mask			
	Step 7	peak pulse amplitude	2.133V		2.607V
	<i>DSX-3 Positive Pulse</i>				
3-226	Step 7	Pulse Mask		Pass/Fail	

Performance Tests
Performance Test Record

Table 11 **Performance Test Record**

Page No.	Test Description		Result		
			Min	Actual	Max
	<i>DSX-3 Negative Pulse</i>				
3-227	Step 6	Pulse Mask		Pass/Fail	
	<i>DSX-1 Positive Pulse</i>				
	Step 7	Pulse Mask		Pass/Fail	
	Step8	peak pulse amplitude	1.984V		2.976V
	<i>DSX-1 Negative Pulse</i>				
3-228	Step 6	Pulse Mask		Pass/Fail	
	Step 7	peak pulse amplitude	1.984V		2.976V
ETSI/ANSI Receiver Equalization (Option 110)					
	<i>2.048Mb/s Equalization</i>				
3-230	Step 6	Trouble Scan		Pass/Fail	
	<i>34.368 Mb/s Equalization</i>				
	Step 5	Trouble Scan		Pass/Fail	
	<i>DS3 Equalization</i>				
3-231	Step 5	Trouble Scan		Pass/Fail	
	<i>DS1 Equalization</i>				
3-232	Step 5	Trouble Scan		Pass/Fail	
ETSI/ANSI Receiver Monitor Levels (Option 110)					
	<i>2.048Mb/s 20dB Monitor</i>				
3-235	Step 6	Trouble Scan		Pass/Fail	
	Step 11	Trouble Scan		Pass/Fail	
	<i>2.048Mb/s 26dB Monitor</i>				
	Step 15	Trouble Scan		Pass/Fail	
	<i>2.048Mb/s 30dB Monitor</i>				
3-236	Step 23	Trouble Scan		Pass/Fail	

Performance Tests
Performance Test Record

Terms

This section contains Tables of ETSI Terms with their ANSI equivalents and current terms with their equivalent earlier terms.

ETSI / ANSI Equivalent Terms

The Terminology used on the instrument display is mainly ETSI terminology. The equivalent ANSI terminology is given in the following table

ETSI Term	ANSI Term
I-n Intra Office, STM-n	Intermediate Reach (IR)
L-n.1 or L-n.2 long haul	LR long reach
Multiplexer Section (MS)	Line
MS-AIS	AIS-L (Line AIS)
MS-BIP	Line BIP
MS-DCC	Line DCC
MS-RDI (MS FERF)	RDI-L (Line FERF)
Multiplexer Section Overhead	Line Overhead
Network Node Interface	Line Interface
AU-AIS (Path AIS)	AIS-P
HP-RDI (Path FERF)	RDI-P
Regenerator	Repeater
Regenerator Section (RS)	Section
Remote Alarm Indicator	Yellow Alarm
Regenerator Section Overhead	Section Overhead
RS-DCC	Section DCC

Installation

ETSI / ANSI Equivalent Terms

ETSI Term	ANSI Term
S-n.1 or S-n.2 short haul	Short Reach (SR)
STM-n	STS-n
SOH	TOH
Section Overhead (SOH)	Transport Overhead (TOH)
Tributary Unit (TU)	Virtual Tributary (VT)
TU	VT
TU-AIS	VT AIS (AIS-V)
TU FERF / TU RDI	RDI-V / VT FERF
TU REI	VT FEBE
VC	SPE
Virtual Container	Payload Envelope
Virtual Container (VC)	Synchronous Payload Envelope (SPE)
VP-RDI (VP-FERF)	VP-RDI
VC-RDI (VC-FERF)	VC-RDI

NOTE: VC is an ETSI abbreviation for Virtual Container and an ETSI / ANSI abbreviation for (ATM) Virtual Channel. The context of VC must therefore be taken into account when converting between standards.

Installation
Current / Previous Terminology

Current / Previous Terminology

Current Terminology	Previous Terminology
B1 BIP	RS B1 BIP
B2 BIP	MS B2 BIP
B3 BIP	Path B3 BIP
MS-AIS	MS AIS
MS-RDI	MS RDI
MS-REI	MS FEBE
HP-IEC	Path IEC
AU-LOP	LOP
AU-AIS	Path AIS
HP-RDI	Path FERF
HP-REI	Path FEBE
TU-LOP	TU LOP
TU-AIS	TU Path AIS
LP-RDI	TU Path FERF
LP-REI	TU Path FEBE

Installation
Current / Previous Terminology

Appendix A - Default Settings

It is often desirable to store measurement settings which are used regularly and be able to recall those settings at a moments notice. This capability is provided in the HP 37717C on the OTHER STORED SETTINGS display.

One preset store is provided which cannot be overwritten, STORED SETTING NUMBER [0], and is used to set the HP 37717C to a known state. The known state is the FACTORY DEFAULT SETTINGS as listed below.

TRANSMIT display (UPDH Option UKK)

Signal	140 Mb/s	Clock Sync	Internal
Code	CMI	Pattern	$2^{23}-1$
Termination	75Ω Unbal		

TRANSMIT display (SPDH Option UKJ)

Settings	Main	Signal	140 Mb/s
Clock Sync	Internal	Termination	75Ω Unbal
Line Code	CMI	Frequency Offset	Off
Payload Type	Unframed	Pattern	$2^{23}-1$
PRBS Polarity	INV	Test Signal	34 Mb/s
34M Payload	Unframed	2M Payload	Unframed
2M Payload	Unframed	34 Mb	1
8 Mb	1	2 Mb	1
64 kb	1	BG Pattern	AIS
User Word	1111111111111111	Error Add	Bit
Error Add Rate	None		

Appendix A - Default Settings

TRANSMIT display (SDH)

Signal	STM-1	Clock Sync	Internal
Payload	140 Mb/s	Payload Pattern	$2^{23}-1$
TUG3	1	TUG2	1
TU	1	2 Mb/s Pattern	$2^{15}-1$

TRANSMIT display (ATM Option UKN)

Signal	34 Mb/s, Internal	Clock Sync	Internal
Code	HDB3	Termination	75Ω Unbal
Cell Stream	Distribution	F/G Bandwidth	80,000 c/s
B/G 1 Bandwidth	0	B/G 2 Bandwidth	0
B/G 3 Bandwidth	0	F/G Distribution	Burst
Burst Size	1 Cell	Interface	UNI
F/G Payload	Cross Cell, $2^{15}-1$	B/G Stream	1
B/G Payload	00000001	Fill Cells	Idle

RECEIVE display (UPDH Option UKK)

Signal	140 Mb/s	Test Mode	Out of Service
Code	CMI	Pattern	$2^{23}-1$
Termination	75Ω Unbal		

Appendix A - Default Settings

RECEIVE display (SPDH Option UKJ, UKL)

Settings	Main	Signal	140 Mb/s
Termination	75Ω Unbal	Line Code	CMI
Gain	20 dB	Equalizer	Off
Payload Type	Unframed	Pattern	2 ²³ -1
PRBS Polarity	INV	Test Signal	34 Mb/s
34M Payload	Unframed	8M Payload	Unframed
2M Payload	Unframed	34 Mb	1
8 Mb	1	2 Mb	1
64 kb	1		

RECEIVE display (SDH)

Signal	STM-1	Payload	140 Mb/s
Payload Pattern	2 ²³ -1	TUG3	1
TUG2	1	TU	1

RECEIVE display (ATM Option UKN)

Signal	34 Mb/s	Termination	75Ω Unbal
Code	HDB3	Interface	UNI
Test Cell	All User	Cell Payload	Cross Cell, 2 ¹⁵ -1

RESULTS display

Results	Trouble Scan	Short Term Period	1 Second
Test Timing	Manual	Single Test Duration	1 Hour
Storage	OFF	SDH Results	Short Term, RS B1 BIP
PDH Results	Short Term		

Appendix A - Default Settings

OTHER display

Stored Setting Lock	On	Stored Setting Number	0
Printer	Internal	Printing	Off
Print Period	OFF	Print Error Seconds	OFF
Print Mode	Normal	Print Speed	9600 Baud
Clock Mode	Run	Keyboard lock	OFF
Beep On Error	OFF	Analysis Display Mode	G.821
Suspend Test on LOS	OFF	Self Test	All Tests
Settings Control	Independent		

Status Registers

Register	+ve Transition	-ve Transition	Enable
ESR	All 1s	All 0s	All 1s
QUES	All 1s	All 0s	All 0s
OPER	All 1s	All 0s	All 0s
INST	All 1s	All 0s	All 1s
DATA	All 1s	All 0s	All 1s
PDH	All 1s	All 0s	All 1s
FAS	All 1s	All 0s	All 1s
SDH	All 1s	All 0s	All 1s
SDH2	All 1s	All 0s	All 1s
SPDH	All 1s	All 0s	All 1s
M140	All 1s	All 0s	All 1s
M34	All 1s	All 0s	All 1s
M8	All 1s	All 0s	All 1s
M2	All 1s	All 0s	All 1s

Appendix B - Fitting, Calibrating & Testing New Modules

Some of the Performance Tests for the HP 37717C require additional modules to be present in the instrument. Table B-1 lists each module (and option) under test and the additional modules which must be present to test it.

To decide if you need to fit any modules, compare Table B-1 with the options listed on the Rear Panel of the instrument under test.

If additional modules are required, follow the procedure below when fitting, calibrating and testing. Some modules also need to be calibrated after fitting (see Table B-1). Calibration procedures for these modules are included here.

Table B-1 Additional Modules Required for Performance Tests

Module Under Test	Option Under Test	Module(s) Required	Part Number	Calibration Required?
Unstructured PDH Tx/Rx	UKK, [USB] special 808	None		No
Structured PDH Tx	UKJ, [USA]	SPDH Rx	37717-60021	No
Structured PDH Rx	UKJ, [USA], UKL, [USC]	SPDH Tx	37717-60020	No
SDH Tx/Rx	US1, [US5], A1T, [A1U] A3R [A3S]	None		No
Optical Tx/Rx	UH1, UH2, URU, USN, UKT, 130, 131	SDH Tx/Rx	37714-60048	No
PDH/SDH Jitter Tx	UHK, A3K	PDH Tx	37714-60044*	No
PDH Jitter Rx	UHN [US9],	Jitter Tx PDH Tx/Rx	37717-60010 37714-60044*	Jitter Tx

Table B-1 Additional Modules Required for Performance Tests

Module Under Test	Option Under Test	Module(s) Required	Part Number	Calibration Required?
STM-1 Electrical Jitter Receiver	A1M, [A1Q] A3L [A3M]	Jitter Tx PDH Tx/Rx SDH Tx/Rx	37717-60010 37714-60044* 37714-60048	Jitter Tx
STM-1 Optical Jitter Rx	A1N, [A1R] A3V [A3W]	Jitter Tx PDH Tx/Rx SDH Tx/RxS TM-1 Optic Tx	37717-60010 37714-60044* 37714-60048 37714-60011**	Jitter Tx
STM-1/4 Optical Jitter Receiver	A1P, [A1S] A3N [A3P]	Jitter Tx PDH Tx/Rx SDH Tx/Rx STM1/4 Optic Tx	37717-60010 37714-60044* 37714-60048 37714-60013**	Jitter Tx
Additional PDH Outputs	UHC, [US6]	PDH Tx/Rx	37714-60044*	No

* 37717-60020/21 may be used (Structured PDH Modules). ** 37714-60012/60013 may be used (STM1/4 Modules).

CAUTION

If 37714-60012 (Option URU) is fitted, the optical output must be attenuated by 10 dB before connecting to the Optical input of any other 37717C optical module. Failure to do this could result in damage to the HP 37717C. Table 3-1 lists a suitable attenuator.

Appendix B - Fitting/Calibrating/Testing New Modules

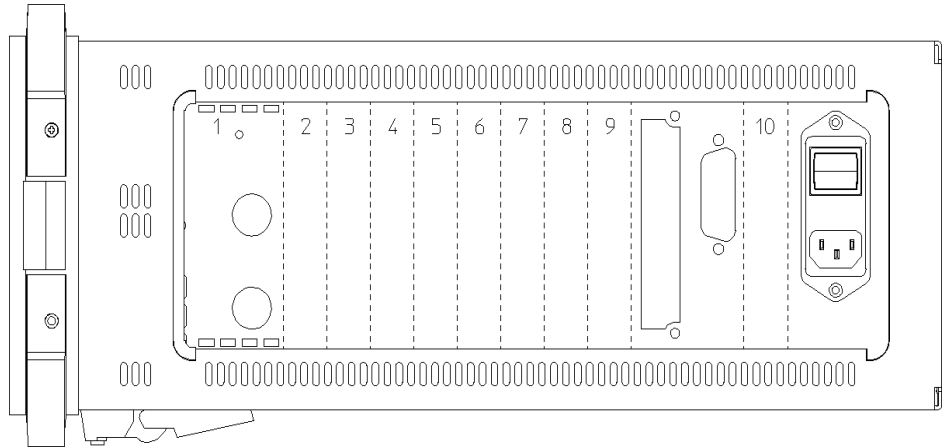

Location of Modules in HP 37717C Mainframe

Table B-2 Configurations for the HP 37717C Modules

Module Description	Option Numbers	Fitting Instructions
Optics	UH1, UH2, URU, USN, UKT, 130, 131	Always Slot 1.
SDH Binary I'face	0YH	Attached to UKT or USN or 130 or 131 in slot 2.
SDH	US1 [US5], A1T [A1U], A3R [A3S]	Immediately to right of SDH Binary. If SDH Binary not fitted immediately to right of Optics..
Unstructured/ Structured PDH (Tx and Rx Modules)	UKK [USB], UKJ [USA]	Tx Module is always on the left side. To right of Jitter TX, PDH Multiple O/ P's, or SDH.
Multiple Outlets	UHC [US6]	Immediately to the right of SDH.
PDH Binary I'face	UH3 [US7]	Immediately to right of PDH RX.

Table B-2 Configurations for the HP 37717C Modules

Module Description	Option Numbers	Fitting Instructions
Jitter Tx	UHK, A3K [A3Q], 140 [141]	If Mult O/P fitted, immediately to the right of this. If Mult O/P not fitted, immediately to the right of SDH. If SDH and Mult. O/P not fitted immediately to right of Optics.
Jitter Rx	UHN [US9], A1M [A1Q],, A1N [A1R], A1P [A1S], A3L [A3M], A3V [A3W], A3N [A3P]	If Binary Interfaces (UH3) fitted Immediately to the right of it. If UH3 not fitted immediately to right of PDH RX. If UH3 and PDH not fitted immediately to right of SDH.
Blanking Plates	37714-00013 (single) 37714-00014 (double)	Blanking Plates should be fitted at the rear (CPU end) to fill in any gaps left after fitting all required modules.

Retrofit Procedure

The following procedure should be used when fitting any new Module into the HP 37717C.

CAUTION

This procedure should only be carried out by qualified Service Personnel.

CAUTION

Anti-static precautions must be observed at all times. - Use the anti-static wrist-strap provided in this kit if an anti-static work-area conforming to Corporate Standard 741.808 is unavailable.

CAUTION

Read the anti-static documentation at the end of this procedure.

- 1** Switch off the instrument and disconnect the power cord.
- 2** Remove the rear panel feet.

Appendix B - Fitting/Calibrating/Testing New Modules

- 3 If Optical Modules are fitted (option UH1, UH2 or URU), unscrew the optical shield from each input and output connector.
- 4 Withdraw the outer cabinet sleeve back and out of the instrument.
- 5 Remove the clamp screws along the top and bottom right-hand side of the chassis which secure blanking plates and modules.

CAUTION

Modules must be removed and fitted in the correct sequence to prevent damage:

CAUTION

From Front to back when removing.

CAUTION

From back to front when fitting.

- 6 Withdraw modules and blanking plates from the instrument.
- 7 Fit all existing modules plus the new module(s) and blanking plates back into the instrument in the order shown in Figure B-1 and Table B-2.
- 8 Secure each module with the two clamp screws.
- 9 Replace the Optical Shields (if optical module fitted), then fit the Outer Cabinet Sleeve and Rear Panel feet as a reversal of the removal procedure.

Testing

- 1 Power on the instrument and check for a sensible display.
- 2 Carry out the instrument selftests (see page 3-5). If the new module also needs to be calibrated (see Table B-1), this must be done before running the selftests. Use the procedures which follow to calibrate the module.
- 3 You can now carry out the required Performance Tests. When all Performance Tests have been successfully completed, return the instrument to its original module configuration.

Jitter Transmitter Module Calibration

If a new Jitter Transmitter Module has been fitted this will need to be calibrated before it can be used, as all calibration data for this module is stored in a special eeprom on the CPU Module.

Description

The Jitter Transmitter Calibration is semi-automatic and is performed by using a special internal calibration routine and a Spectrum Analyzer. The HP 37717C TX PDH OUTPUT is connected to the Analyzer (via 75Ω/50Ω Matching Pad) and set to the first calibration point in the routine. With the Analyzer set to display the transmitted data spectrum, a Bessel Null should be observed. The HP 37717C DAC output is adjusted using the calibration routine to optimise this Bessel Null. This sets the transmitted jitter to exactly 0.765UI. This process is repeated for all other Calibration points in the routine.

Equipment

Spectrum Analyser	HP 8568B
75Ω/50Ω Matching Pad	HP 8568B

Pre-Adjustment Setup

Before carrying out Jitter Transmitter Calibration, you will need to perform the following pre-adjustment setup.

1. Recall the HP 37717C Default Settings with the following key sequence;
2. Press **OTHER**, then **STORED SETTINGS**. Select STORED SETTINGS number [0]. Select ACTION [RECALL].
3. Couple the HP 37717C transmitter and Receiver with the following key sequence;
Press **OTHER**, then **SETTINGS CONTROL**. Select TRANSMITTER & RECEIVER [COUPLED]

Appendix B - Fitting/Calibrating/Testing New Modules

4. Make the following key sequence on the HP 37717C to obtain the MODULE DEBUG display.

Press **OTHER**; 

MORE; 

MORE; 

MORE; **OTHER**.

Press **MORE** until MODULE DEBUG appears in the softkey menu.

CAUTION

When using the MODULE DEBUG display, only modify parameters shown below. Altering other parameters can cause damage to the instrument - prevent accidental damage by leaving the Module Debug Page after setting up.

5. Press MODULE DEBUG and select MODULE [PDH MODULE] on the Display.
6. Select VCO CONTROL MODE [FIXED].
7. Select MODULE [JITTER MODULE] on the Module Debug Display.
8. Select TX CALIBRATION [ON].
9. Select RX CALIBRATION [OFF].

CAUTION

The previous pre-adjustment sequence will need to be performed again if power is cycled during Jitter Calibration, as MODULE DEBUG parameters return to default values when instrument power is cycled.

Jitter Transmitter Calibration Procedure

1. Connect the HP 37717C Transmitter Output to the Spectrum Analyzer via the 75 Ω /50 Ω Matching Pad.
2. Set the Spectrum Analyzer as follows:
Centre Frequency 2048kHz
Reference Level 0dBm
Video Bandwidth 1kHz
Frequency Span 100kHz
Sweep Time 1.0 seconds
Resolution Bandwidth 100Hz
3. Press the **OTHER** then **MORE** twice. Select the CALIBRATION function.

Appendix B - Fitting/Calibrating/Testing New Modules

4. Select CALIBRATE PASSWORD and set to [1243] using **INCREASE DIGIT** and **DECREASE DIGIT**.
5. Select the calibration item [JITTER Tx].
6. Press **RUN/STOP** to start calibration. The Spectrum analyzer should display a symmetrical spectrum of lines similar to that shown in Figure B-2. The central line is the transmission carrier.

NOTE

If the calibration routine will not start (**RUN/STOP** led will not light), ensure that the instrument TIME and DATE are set correctly - refer to the Mainframe Operating Manual for setup procedures for the internal clock.

7. Move the cursor to DAC and adjust the DAC value (using only the Least Significant Bit) until the carrier level displayed on the Spectrum Analyzer is at a minimum. (Bessel Null).
8. When the Bessel Null is obtained, move the cursor to TOGGLE WHEN AT ZERO POINT and press ZERO POINT softkey. This stores the value for the modulation frequency and the routine automatically moves on to the next calibration value.
9. Repeat steps 7 and 8 for each new calibration value. At each change of BIT RATE, set the Spectrum Analyzer center frequency to the new BIT RATE and re-adjust the span to optimise the spectrum around the carrier.
10. When finished, the HP 37717C display should show the new Calibration Date and the **RUN/STOP** led should be extinguished.
11. Press **TRANSMIT** to return to normal operation then disconnect all test equipment.

Appendix B - Fitting/Calibrating/Testing New Modules

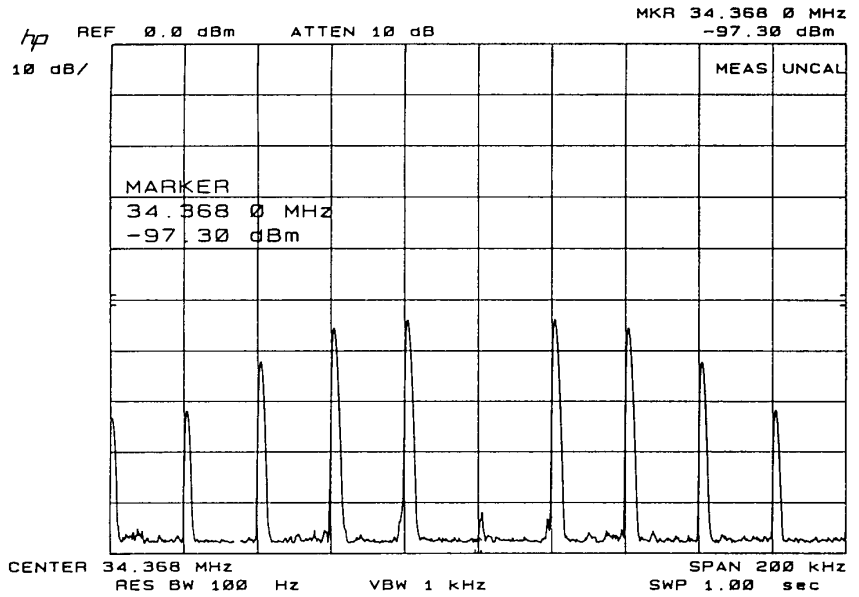

Typical Jitter Transmit Spectrum

Index

Numerics

2M REF IN Connector, 2-9
75 ohm OUT 1 Connector, 2-7
75 ohm OUT 2 Connector, 2-7
75 ohm OUT 3 Connector, 2-7

A

Accessories
 Connection, 2-15
Alternative External MTS Clock, 208
ANSI / ETSI Equivalent Terms, 4-1
Assistance, 1-3
Australian EMC Regulations
 Compliance with, 1-10

C

Cabinet Cleaning, 1-8
Certification, 1-3
Cleaning, 1-8
 Cabinet, 1-8
 Optical Connectors, 1-8
CLOCK IN Connector, 2-7
CLOCK OUT (Opt 110) Connector, 2-8
CLOCK OUT (Opt OYH) Connector, 2-7
Compliance, Statement of, 1-10
Connecting
 Accessories, 2-15
 ESD Precautions Necessary, 2-6
 To the Network, 2-6
 To the Power Supply, 2-4
Connectors
 Electrical Interface, 2-6
 Optical Interface, 2-10

D

DATA IN Connector, 2-8
DATA OUT Connector, 2-8
Datacomm Port Loopback, 5
Declaration of Conformity, 1-12
DEMODO OUT Connector, 2-9
DEMUX 2 Mb/s 75 ohm Connector, 2-8
DEMUX Connector, 2-8
DEMUX DS1 100 ohm Connector, 2-8
Dimensions and Weight, 1-5
DS1 100 ohm, 2Mb/s 120 ohm IN Connector, 2-7
DS1 100 ohm, 2Mb/s 120 ohm OUT, 2-7

DS3, 2Mb/s, 34Mb/s 75 ohm IN Connector, 2-6
DS3, 2Mb/s, 34Mb/s 75 ohm OUT Connector, 2-6

E

Electrical Interface Connectors, 2-6
Electromagnetic Compatibility, 1-11
Electrostatic Discharge, 1-11
Environment
 Operating, 2-2
 Storage and Shipment, 1-4
ERROR OUT Connector, 2-7
ESD Precautions
 For the Service Engineer, 2-6, 2-18
ETSI / ANSI Equivalent Terms, 4-1
EXT MTS CLOCK Connector, 2-7
External 2Mb/s Mux/Demux, 55
External MTS Clock, 82, 208

F

Fitting, Calibrating and Testing New Modules, B-1
Fuse Replacement, 2-3
Fuses, 2-3

H

HANDSET Connector, 2-15
Hewlett-Packard Interface Bus, 2-16
HP-IB, 2-16
 Address Selection, 2-17
 Connections, 2-17
HP-IB Address, 2-17
HP-IB Connection, 2-16

I

Inspection, Initial, 2-1
Instruments Covered By Manual, 1-4
Internal SDH Transmitter Clock, 77, 78, 204, 205

J

Jitter Receiver STM-1 Optical Interface, 162
Jitter Receiver STM-1/STM-4 Optical Interface, 165
Jitter Receiver STM-1E Input Equalization, 159

Jitter Receiver STM-1E Monitor Input, 160

L

Laser apertures
 Location, 2-13
LID Connector, 2-15
Lifting/Carrying the Instrument, 1-6
Line Voltage Selector Switch, 2-4
Location of Laser Apertures, 2-13

M

Maintenance by the Operator, 1-8
Multiple PDH Transmitter Outputs, 22, 34
MUX 2 Mb/s 75 ohm Connector, 2-8
MUX Connector, 2-8
MUX DS1 100 ohm Connector, 2-8

N

Noise Declaration (German), 1-10

O

Operators Maintenance, 1-8
Optical Connector Cleaning, 1-8
OPTICAL IN Connector, 2-14
Optical Interface Connectors, 2-10
OPTICAL OUT Connector, 2-14

P

PDH Binary Interfaces, 168, 174, 175
PDH Error Output, 71, 72
PDH Frame Analysis, 35, 42
PDH Frequency Measurement and Looped Clock, 73, 75
PDH IN Connector, 2-6
PDH Internal Transmitter Clocks, 6, 8
PDH OUT Connector, 2-6
PDH Receiver Equalization, 43, 46
PDH Receiver Monitor Levels, 47, 49
PDH Transmitter Output, 8, 21
Performance Test Record, 237
Power Cord, 2-5
Power Requirements, 2-3
Power Supply Connection, 2-4
Precautions
 ESD when connecting, 2-6
 Precautions for the Service Engineer, 2-18
Preparation for Use, 2-3

Index

Printer HP-IB, RS232, PARALLEL ONLY Connector, 2-15

R

Recall Default Settings, 2
Recommended Test Equipment, 3
Remote Control HP-IB, RS232, 10 BASE -T Connector, 2-15
Repackaging, 1-4
Responsibilities of the Customer, 1-2
Restricted Rights Legend, 1-3
RS 449 Connector, 2-9

S

Safety Information, 1-6
Safety Precautions
 For the Operator, 1-6
 For the Service Engineer, 2-18
Safety Symbols, 1-7
SDH Frequency Offsets, 79, 81, 206, 208
Self Test, 3
Serial Number Plate, 1-4
Shipping Container Inspection, 2-1
SPDH Receiver Monitor Levels, 50, 54, 233, 236
Statement of Compliance, 1-10
STM-1 / STM-4 IN Connector, 2-9
STM-1 IN Connector, 2-7
STM-1 Optical Interface, 98, 100, 164
STM-1 OUT Connector, 2-7
STM-1 Receiver Input Equalization, 97, 217
STM-1 Receiver Monitor Input, 91, 96, 216
STM-1 Transmitter Output Waveshape, 85, 90, 209, 214
STM-1/STM-4 Optical Interface, 101, 103, 109, 116, 167
STM-1/STM-4 Optical Interface (Options UKT, USN), 117
STM-1E IN Connector, 2-8
Storage and Shipment, 1-4
Symbols, Safety, 1-7

T

Terminology
 Current / previous, 4-3
 ETSI / ANSI, 4-1

TRIG OUT Connector, 2-9

V

VGA Connector, 2-15
Voltage, line Selector Switch, 2-4

W

Wander/Slips Measurements, 153, 158
warning symbols, 2-11
Warranty, 1-1
Weight and Dimensions, 1-5

Hewlett-Packard Sales and Service Offices

If you need technical assistance with a Hewlett-Packard test and measurement product or application please contact the Hewlett-Packard office or distributor in your country.

Asia Pacific:

Hong Kong:

Tel: (852) 2599 7889

India:

Tel: (91-11) 682-6000

Japan:

Hewlett-Packard Japan Ltd.
Measurement Assistance Center
9-1, Takakura-Cho, Hachioji-Shi,
Tokyo 192-8510, Japan
Tel: (81) 426-56-7832
Fax: (81) 426-56-7840

Korea:

Tel: (82-2) 769 0800

Malaysia:

Tel: (60-3) 291 0213

Philippines:

Tel: (63-2) 894 1451

People's Republic of China:

Tel: (86-10) 6505 0149

Singapore:

Tel: (1800) 292 8100

Taiwan:

Tel: (886-3) 492 9666

Thailand:

Tel: (66-2) 661 3900

For countries in Asia Pacific not listed, contact:

Hewlett-Packard Asia Pacific Ltd
17-21/F Shell Tower, Times Square,
1 Matheson Street
Causeway Bay
Hong Kong
Tel: (852) 2599 7777
Fax: (852) 2506 9285

Australia/New Zealand:

Hewlett-Packard Australia Ltd.
31-41 Joseph Street
Blackburn, Victoria 3130
Australia
Tel: 1 800 629 485

Canada:

Hewlett-Packard Canada Ltd.
5150 Spectrum Way
Mississauga, Ontario
L4W 5G1
Tel: (905) 206 4725

Europe, Africa and Middle East:

Austria:

Tel: (0)1 25000-0

Belgium and Luxembourg:

Tel: (02) 778 3417

Baltic Countries:

Tel: (358) 08872 2100

Czech Republic:

Tel: 420-2-4743111

Denmark:

Tel: 45 99 10 00

Hewlett-Packard Sales and Service Offices (cont'd)

Finland:

Tel: (90) 88 721

France:

Tel: (0)1 69.82.60.60

Germany:

Tel: (0180) 532 62-33

Greece:

Tel: 30-1-7264045

Hungary:

Tel: 36-1-4618219

Ireland:

Tel: (01) 284 4633

Israel:

Tel: 972-3-5380333

Italy:

Tel: 02 - 92 122 241

Netherlands:

Tel: (020) 547 6669

Norway:

Tel: (22) 73 57 50

Poland:

Tel: 48-22-6087700

Portugal:

Tel: (11) 482 85 00

Russia:

Tel: (7/095) 928 6885

Fax: (7/095) 916 9844

South Africa:

Tel: 27-22-8061000

Spain:

Tel: (34) 1 631 1323

Sweden:

Tel: (08) 444 22 77

Switzerland:

Tel: (01) 735 7111

Turkey:

Tel: 90-212-2245925

United Kingdom:

Tel: (01344) 366 666

For countries in Europe/Middle East and Africa not listed, contact:

Hewlett-Packard

International Sales Europe

Geneva, Switzerland

Tel: +41-22-780-4111

Fax: +41-22-780-4770

Latin America:

Hewlett-Packard

Latin American Region Headquarters

5200 Blue Lagoon Drive

9th Floor

Miami, Florida 33126

U.S.A.

Tel: (305) 267-4245

Tel: (305) 267-4220

Fax: (305) 267-4288

United States:

Hewlett-Packard Company

Test and Measurement Organization

5301 Stevens Creek Blvd.

Bldg. 51L-SC

Santa Clara, CA 95052-8059

Tel: 1 800 452 4844

About This Edition

This is the second edition of the Calibration Manual. It documents the product as of 11/98. Edition dates are as follows:

1st Edition March 98
2nd Edition November 98

© Copyright Hewlett-Packard Ltd. 1998

All rights reserved.
Reproduction, adaption, or translation without prior written permission is prohibited, except as allowed under the copyright laws.

In This Book

This book contains the instrument specifications and provides techniques for checking them.

